

PUV-1530TXRX

HDCP 2.2 & HDMI2.0 Extender with OAR / Audio Insertion

HDCP 2.2 HDMI® HDBT® 4K2K



Operation Manual

SAFETY PRECAUTIONS

Please read all instructions before attempting to unpack, install or operate this equipment and before connecting the power supply.

Please keep the following in mind as you unpack and install this equipment:

- Always follow basic safety precautions to reduce the risk of fire, electrical shock and injury to persons.
- To prevent fire or shock hazard, do not expose the unit to rain, moisture or install this product near water.
- Never spill liquid of any kind on or into this product.
- Never push an object of any kind into this product through any openings or empty slots in the unit, as you may damage parts inside the unit.
- Do not attach the power supply cabling to building surfaces.
- Use only the supplied power supply unit (PSU). Do not use the PSU if it is damaged.
- Do not allow anything to rest on the power cabling or allow any weight to be placed upon it or any person walk on it.
- To protect the unit from overheating, do not block any vents or openings in the unit housing that provide ventilation and allow for sufficient space for air to circulate around the unit.

REVISION HISTORY

VERSION NO.	DATE DD/MM/YY	SUMMARY OF CHANGE
VR0	08/03/16	Preliminary Release

CONTENTS

1. Introduction	1
2. Applications	1
3. Package Contents	1
4. System Requirements	2
5. Features	2
6. Operation Controls and Functions	3
6.1 Front Panel of Transmitter	3
6.2 Rear Panel of Transmitter	4
6.3 Right Side Panel of Transmitter	4
6.4 Front Panel of Receiver	10
6.5 Rear Panel of Receiver	11
6.6 IR Cable Pin Assignment.....	11
6.7 D-Sub 9 Pin Definitions	12
7. Specifications	13
7.1 CAT5e/6/7 Cable Specification	15
7.2 Timing Support Table	15
7.3 HDBT Features	16
8. Connection and Installation	17
9. Acronyms	18

1. INTRODUCTION

The HDMI over single CAT5e/6/7 Transmitter and Receiver set is a great solution to extend uncompressed audio/video and IP data over a single run of CAT5e/6/7 cable at a distance up to 100 meter. Multi-control interfaces are available which includes IR, RS-232, USB and LAN connection. This new extender set complies with advanced protocols of HDCP2.2 and HDMI 2.0, the HDCP1.4 also supported. The 6G HDMI video is able to be processed. Except extend 4K2K data, it features useful audio functions. The "optical audio return" supports audio transmit back from Receiver to Transmitter. Besides, the "audio insertion" allows external audio insert to HDMI video such as background music insertion. The HDBT clock stretch and TMDS re-clocking are considered. The Receiver (PD) can be powered by the PoE 48V function of the Transmitter (PSE), allowing for greater flexibility to fit different installation scenarios.

2. APPLICATIONS

- 48V PoE from Transmitter (PSE) to Receiver (PD)
- Household entertainment sharing and control
- Lecture room display and control
- Showroom display and control
- Meeting room presentation and control
- Classroom display and control

3. PACKAGE CONTENTS

- 1 x HDMI over CAT5e/6/7 Transmitter
- 1 x HDMI over CAT5e/6/7 Receiver
- 1 x IR Blaster
- 1 x IR Extender
- 1 x 48V / 0.83A DC power adapter
- 1 x Power cable
- 2 x RS232 terminal block pitch
- 2 x Audio terminal block
- 1 x Operation Manual

4. SYSTEM REQUIREMENTS

Input source equipment such as PS3/Blu-ray player and output HD TV/ display.

5. FEATURES

- HDCP 1.4/HDCP 2.2 and HDMI 2.0 compliant
- HDMI with 3D, 4K2K support and DVI Compliant
- 6G HDMI video (3840x2160 YUV444) input is supported
- Simultaneous transmission of uncompressed data over a single CAT5e/6/7 cable up to 100m /328 ft at 1080p and 70m/230ft at 4K2K
- 5Play™ convergence: HDMI, LAN, PoE & Control (IR & RS-232)
- Supports output resolution up to 4K2K@50/60_YUV_420
- Supports deep color input and output of 8 bits, 10 bits and 12 bits
- Supports CEC bypass
- Optical audio return supports audio transmit back from receiver to transmitter
- Audio insertion supports external audio insert to HDMI video such as background music insertion
- Supports EDID management PC software with default EDID and native EDID from display or other sink devices
- Supports HDMI DDC bus clock stretch for better compatibility of some Blu-ray players
- Manages TMDS re-clocking and signal re-generation for better signal
- Supports standard 48V from Transmitter (PSE) to Receiver (PD)
- Easily firmware update via USB in field
- Ultra-thin wall plate design with friendly installation (The thickness is 16mm only)

Note: 1. *The standard 48V PoE function is designed for powering compatible Receiver units only---non-PoE Receivers will need their own power supply. Receivers of another brand may not be compatible.*

2. *Displaying HDMI 3D and 4K2K contents, equivalent source signal and HDMI cable are required in order to secure the quality.*

6. OPERATION CONTROLS AND FUNCTIONS

6.1 Front Panel of Transmitter

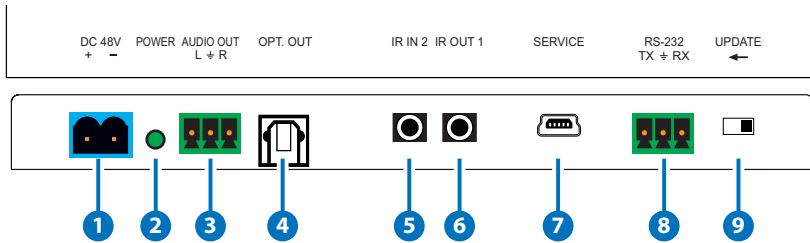

- 1 DC 48V:** Plug the 48V DC power supply into the unit. Please do follow the label on adapter to connect the black cable to ground pin of connector.
- 2 Power LED:** This LED will illuminate once the device is connected to a power supply.
- 3 Audio out:** Connects to speaker with RCA input for audio signal output.
- 4 OPT. out:** The optical out is for receiving optical audio from Receiver then transmits to other connected devices such as speakers.
- 5 IR Out 1:** IR Out 1 is considered as IR extender which to connect to the supplied IR Extender cables for IR signal reception. Ensure that remote being used is within the direct line-of-sight of the IR Extender.
- 6 IR In 2:** IR In 2 is considered as IR BLASTER which connects to the supplied IR Blaster cable for IR signal transmission. Place the IR Blaster in direct line-of-sight of the equipment to
- 7 SERVICE:** This service slot is USB2.0 which is for firmware update purpose.
- 8 RS-232:** Connect to a PC or Laptop via RS232 terminal to D-Sub 9-pin cable for the transmission of RS-232 commands.
- 9 Update:** When update the firmware, the switch shall arrange to left side (just follow arrow direction on case) and arrange back when completing update.

6.2 Rear Panel of Transmitter

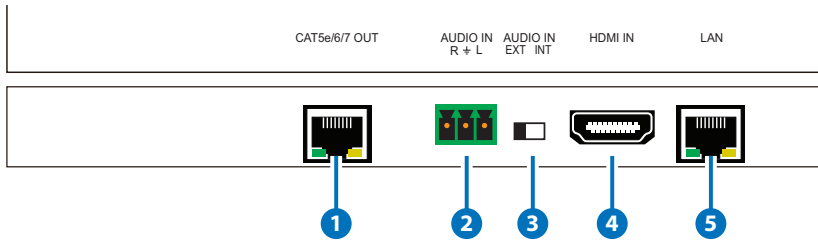

- 1 CAT5e/6/7 Out:** Connects to the Receiver unit with a single CAT5e/6/7 cable for transmission of all data signals includes power.
- 2 Audio In:** This phoenix connector allowing connect to analog audio devices such as DVD players.
- 3 Audio In Ext / Int:** The slide switch provides customer to select external audio which means insert external audio to displayed video. Please slide the switch to EXT for external audio insertion. The slide switch at "INT" means audio remain current HDMI one.
- 4 HDMI IN:** Connects to HDMI source equipment such as a DVD or Blu-ray player.
- 5 LAN:** Connects to an internet or network system.

6.3 Right Side Panel of Transmitter

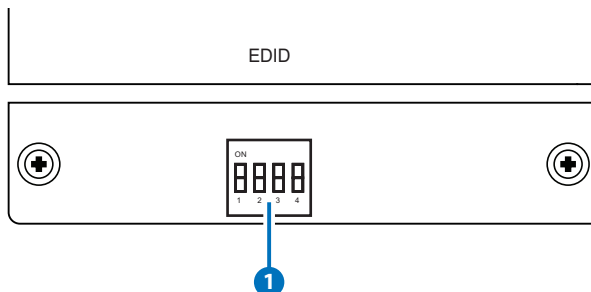

- 1 EDID:** EDID switch offers EDID selection. There are 16 sets of EDID selection totally which divide to three modes includes "internal mode", "user mode" and "native mode". 6 set of internal EDID, 9 sets are defined as user mode which are allowing customer to

upload as prefer one. The last one is native EDI which copies EDID from sink device.

Dipswitch Selection for EDID:

Mode	Number	Dipswitch Number
Internal Mode	1	0000
	2	1000
	3	0100
	4	1100
	5	0010
	6	1010
User Mode	7	0110
	8	1110
	9	0001
	10	1001
	11	0101
	12	1101
	13	0011
	14	1011
	15	0111
Native Mode	16	1111

EDID Detail Information:

1) Internal Mode:

1. Internal Mode FHD / 2 channel: 1080p/60 148M, No deep color 8bits, 2Ch
1. FHD / 2 channel: 1080p/60 148M, No deep color 8bits, 2Ch
2. FHD/ Multi channel: 1080p/60 148M, No deep color 8bits, 8Ch
3. UHD / 2 channel: 3840 x 2160p/30Hz 297M, No deep color 8bits, 2Ch
4. UHD / Multi channel: 3840 x 2160p/30Hz 297M, No deep color 8bits, 8Ch
5. UHD+ / 2 channel: 3840 x 2160p/60Hz 594M, deep color 12bits, 2Ch
6. UHD+ / Multi channel: 3840 x 2160p/60Hz 594M, deep color 12bits, 8Ch

2) User Mode:

1. User Mode Upload mode. Default: FHD / 2 channel: 1080p/60 148M, No deep color 8bits, 2Ch
2. Upload mode. Default: FHD / 2 channel: 1080p/60 148M, No deep color 8bits, 2Ch
3. Upload mode. Default: FHD / 2 channel: 1080p/60 148M, No deep color 8bits, 2Ch
4. Upload mode. Default: FHD / 2 channel: 1080p/60 148M, No deep color 8bits, 2Ch
5. Upload mode. Default: FHD / 2 channel: 1080p/60 148M, No deep color 8bits, 2Ch

6. Upload mode. Default: FHD / 2 channel: 1080p/60 148M, No deep color 8bits, 2Ch
 7. Upload mode. Default: FHD / 2 channel: 1080p/60 148M, No deep color 8bits, 2Ch
 8. Upload mode. Default: FHD / 2 channel: 1080p/60 148M, No deep color 8bits, 2Ch
 9. Upload mode. Default: FHD / 2 channel: 1080p/60 148M, No deep color 8bits, 2Ch
- 3) Native mode:
1. Copy EDID from sink device
- 4) EDID Upload Steps For User Mode
1. Connects PC USB to mini-USB service port of Transmitter
 2. Arranging dipswitch to exactly mode to upload (mode 7 to 15 allows user to upload EDID)
 3. Open EDID tool "CDPS 2016" and click "Search" button

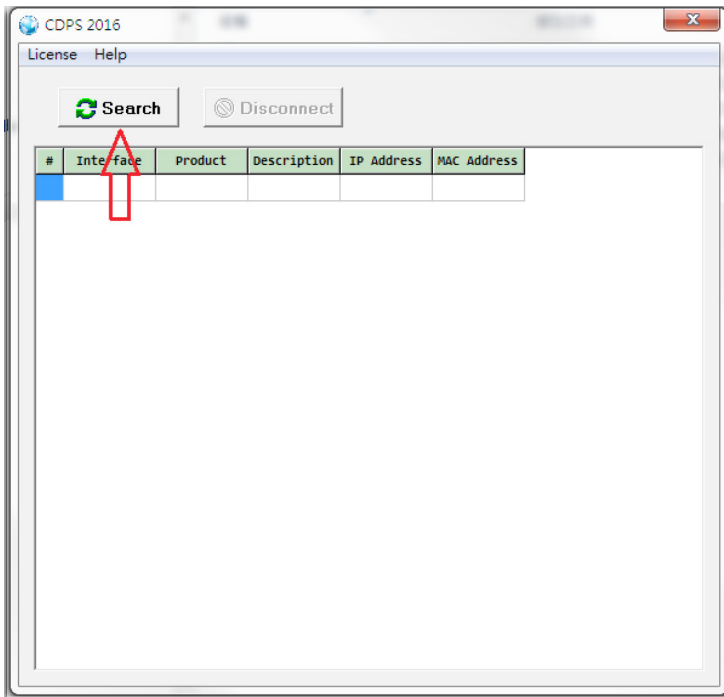

4. Move mouse cursor and click left button at following position to generate another working window

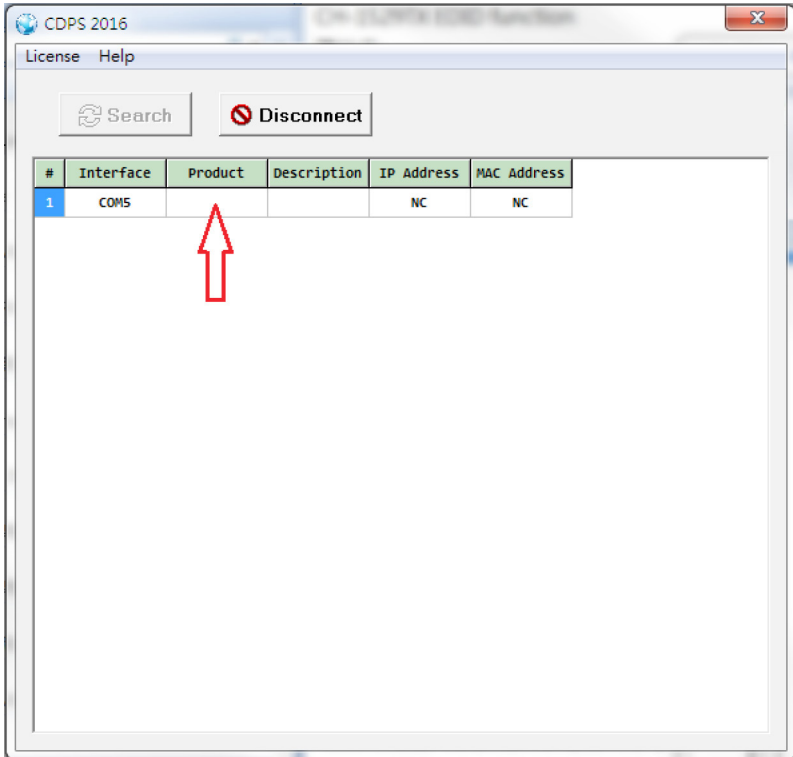

5. Following window will be generated, please click file icon

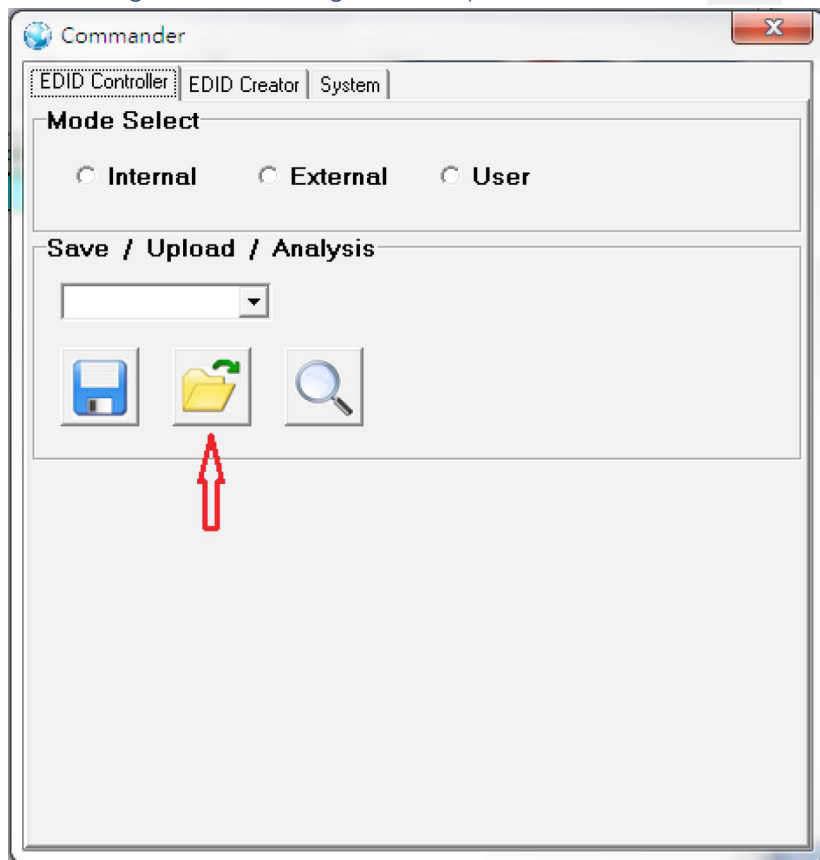

6. Select EDID bin file to upload and EDID completes upload.

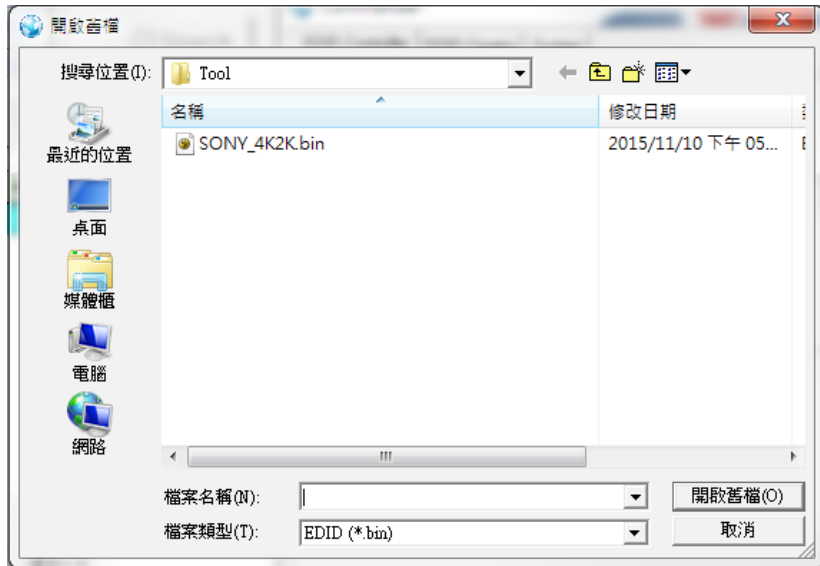

6.4 Front Panel of Receiver

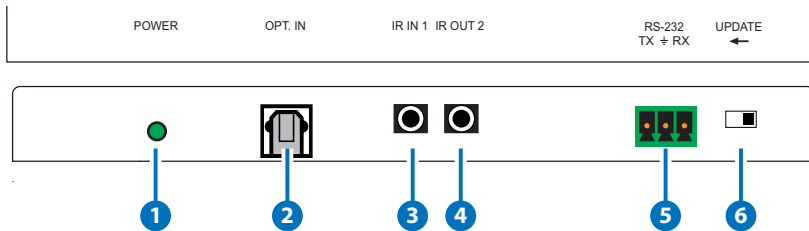

- 1 Power LED:** This power LED will illuminate when receiving the power from transmitter.
- 2 OPT. In:** Connects with optical audio source as optical audio return which allowing audio transmit to Transmitter.
- 3 IR IN 1:** IR IN 1 considered as IR extender which to connect to the supplied IR Extender cables for IR signal reception. Ensure that remote being used is within the direct line-of-sight of the IR Extender.
- 4 IR Out 2:** IR Out 2 considered as IR BLASTER which connects to the supplied IR Blaster cable for IR signal transmission. Place the IR Blaster in direct line-of-sight of the equipment to be controlled.
- 5 RS-232:** Connect to the device that is to be controlled (via RS232 terminal connects with D-Sub 9-pin cable) by RS-232 commands.
- 6 Update:** When update the firmware, the switch shall arrange to left side (just follow arrow direction on case) and arrange back when completing update.

6.5 Rear Panel of Receiver

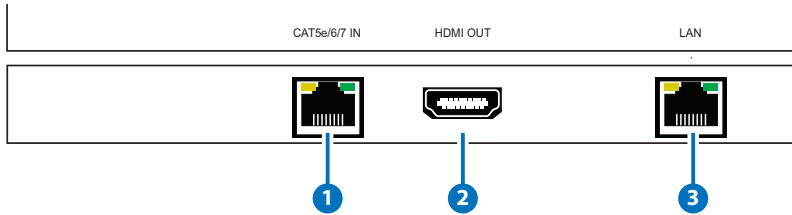

- 1 CAT5e/6/7 IN:** Connect to the transmitter unit with a single CAT5e/6/7 cable for transmission of all data signals and power.
- 2 HDMI Out:** Connects to HDMI sink equipment such as a display.
- 3 LAN:** Connects to an internet or network system.

6.6 IR Cable Pin Assignment

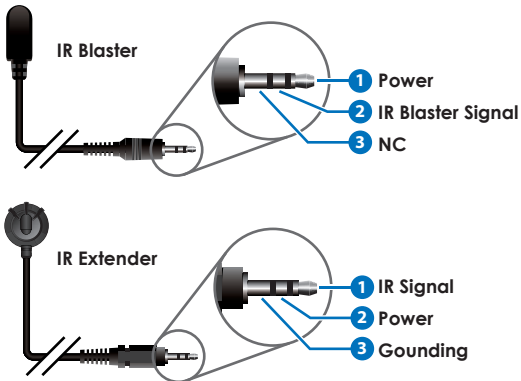

6.7 D-Sub 9 Pin Definitions

Pin	Define TX / RX
1	NC
2	TxD / RxD
3	RxD / TxD
4	N/C
5	GND
6	N/C
7	N/C
8	N/C
9	N/C

7. SPECIFICATIONS

Video Bandwidth	340MHz / 10.2Gbps
Transmitter	
Input Ports	1 x HDMI 1 x Audio In slide switch 1 x Audio In connector 1 x IR In 2
Output Ports	1 x Optical Out 1 x Audio Out 1 x CAT5e/6/7 1 x IR Out 1 x IR Out 1
Other	1 x RS-232 1 x LAN 1 x SERVICE (USB 2.0 for PC host connection and firmware update) 1 x Update slide switch
EDID Selection	1 x EDID dip switch
Receiver	
Input Ports	1 x CAT5e/6/7 1 x IR In 1 x Optical In
Output Ports	1 x HDMI 1 x IR Out 2
Others	1 x LAN 1 x RS-232 1 x Update slide switch

HDMI Resolution	HD: 480i~4K2K@50/60 _ YUV_420 PC: VGA ~ WUXGA
Resolution	
HDMI Cable Distance	In: 10m/1080p@8-bit or 12-bit and 5m@4K2K Out:10m/1080p@8-bit or 12-bit and 5m@4K2K
CAT5e/6/7 Cable Distance	Up to 100m
RS232 Baud Rate	Up to 115200 bps
IR Frequency	30~50kHz
ESD Protection	Human Body model: ± 8kV (air-gap discharge) ± 4kV (contact discharge)
Dimensions	78mm (W) x 163mm (D) x 16mm (H) Excluded jacks 78mm (W) x 183mm (D) x 16mm (H) Included rack ears
Weight	340g for Transmitter and 338g for Receiver
Chassis Material	Metal
Color	Black
Operating Temperature	0°C~40°C / 32°F ~ 104°F
Storage Temperature	-20°C~60°C/-4°F~140°F
Relative Humidity	20~90% RH (non-condensing)
Power Consumption	19.5W

7.1 CAT5e/6/7 Cable Specification

Cable Type	Range	Pixel Clock Rate	Video Data Rate	Supported Video Formats
CAT5e/6/7	100m	≤225MHz	≤5.3Gbps (HD Video)	Up to 1080p@60Hz, 36-bit, 3D (data rates lower than 5.3Gbps or below 225MHz TMDS clock).
	70m/ CAT5e/6 100 m/CAT7	>225MHz	>5.3Gbps (Ultra HD Video)	4K2K@30Hz video formats

7.2 Timing Support Table

HDMI	INPUT	OUTPUT
480i x 576i	Support	Support
480p x 576p	Support	Support
720p@50&60	Support	Support
1080i@50&60	Support	Support
1080p@50&60	Support	Support
640x480	Support	Support
800x600	Support	Support
1024x768	Support	Support
1600x1200	Support	Support
1920x1200	Support	Support
3840x2160p@50/60(YUV_444)	Support	Not support

7.3 HDBT Features

HDBase T Feature	Support or Not
Video & Audio	Support
IR	Support
RS232	Support
Send power to Transmitter	No
Send power to Receiver	Support
LAN	Support

8. CONNECTION AND INSTALLATION

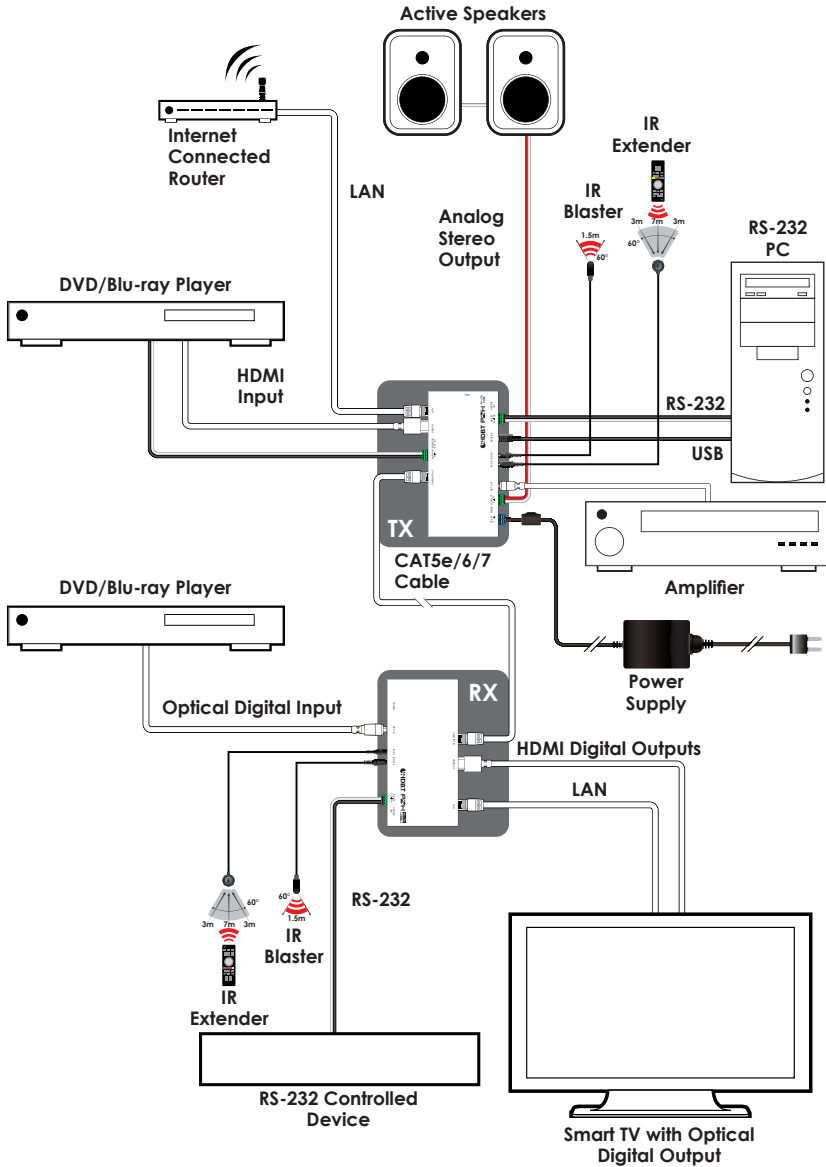

9. ACRONYMS

ACRONYM	COMPLETE TERM
CAT5e	Category 5 Cable
CAT6	Category 6 Cable
CAT7	Category 7 Cable
CEC	Consumer Electronics Control
DVI	Digital Visual Interface
HDCP	High-bandwidth Digital Content Protection
HDMI	High-Definition Multimedia Interface
IR	Infrared
PD	Powered Device
PSE	Power Sourcing Equipment

