

**ROHS**

REV.	REVISIONS	DATE	BY
------	-----------	------	----

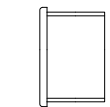

Dust cover

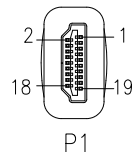
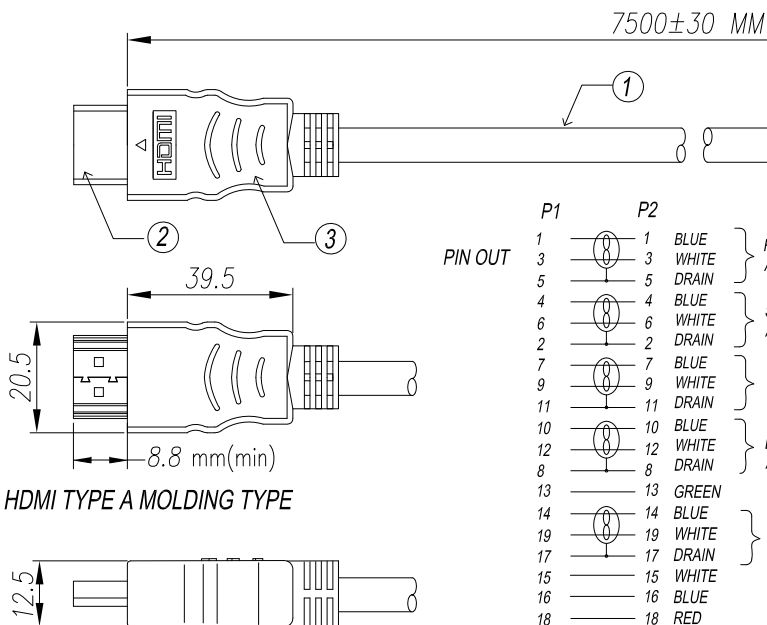

HDMI TYPE A MOLDING TYPE

PIN OUT		P1	P2	
1	1	BLUE	1	RED AM
3	3	WHITE	3	
5	5	DRAIN	5	SILVER AM
4	4	BLUE	4	
6	6	WHITE	6	BLUE AM
2	2	DRAIN	2	
7	7	BLUE	7	BROWN AM
9	9	WHITE	9	
11	11	DRAIN	11	GREEN AM
10	10	BLUE	10	
12	12	WHITE	12	GREEN AM
8	8	DRAIN	8	
13	13	GREEN	13	
14	14	BLUE	14	
19	19	WHITE	19	
17	17	DRAIN	17	
15	15	WHITE	15	
16	16	BLUE	16	
18	18	RED	18	

SHELL DRAIN SHELL

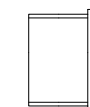
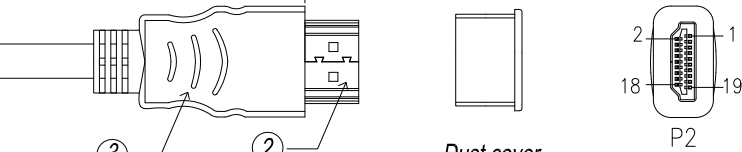

Dust cover

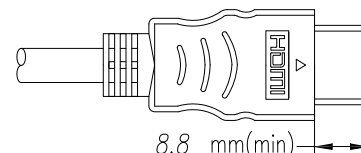

HDMI TYPE A MOLDING TYPE

**NOTES:**

**1.ELECTRICAL TEST:**

- <1> 100% OPEN SHORT&MISS WIRE TEST
- <2> INSULATION RESISTANCE: DC 300V 10Mohm
- <3> CONDUCTOR RESISTANCE: 3 ohm

**2.CABLE MARKING**

High Speed HDMI® with Ethernet, 4K Support

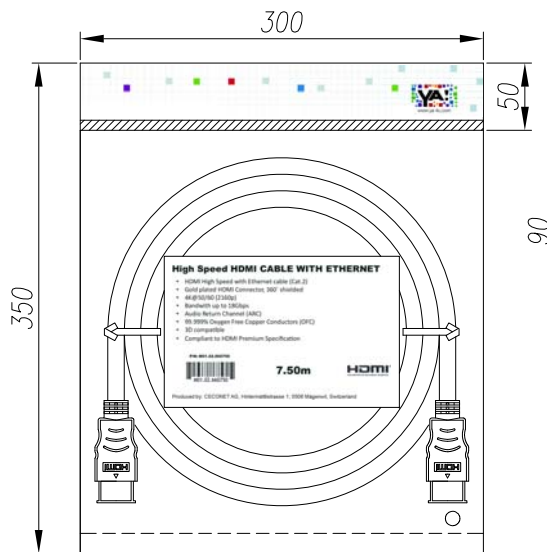

**High Speed HDMI CABLE WITH ETHERNET**

- HDMI High Speed with Ethernet cable (Cat.2)
- Gold plated HDMI Connector, 360° shielded
- 4K@50/60 (2160p)
- Bandwith up to 18Gbps
- Audio Return Channel (ARC)
- 99.999% Oxygen Free Copper Conductors (OFC)
- 3D compatible
- Compliant to HDMI Premium Specification

P/N: M01.02.660750



M01.02.660750

**7.50m**



Produced by: CECONET AG, Hintermättlistrasse 1, 5506 Mägenwil, Switzerland

3	ALL HOOD	Moulded PVC
2	CONN	2x HDMI connector with gold plated contacts, screen cover and protection cover.
1	CABLE	(7/0.12BC*1P+7/0.12BC+AM)*5PCS+7/0.12BC*4C+AM+7/0.12BC+128/0.12ALM+ PVC JACKET (OD:Φ7.3±0.2mm)

TOLERANCE		SCALE	SHEEL	DRAWN BY	DATE
.X	±0.25	1 : 1	1 OF 1	Peter	22/06/2016
.XX	±0.10	REV.		CHECKED BY	DATE
ANGLES	±1°	A.2		-	-
		MATERIAL		THIRD ANGLE PROJECTION	

**High Speed mit Ethernet,  
HDMI 2.0, 4K, sw, 7.5m**

PART NO.	DWG NO.
M01.02.660750	-

