

	0.1/12	0.1/12	0.1/12
3.5 3p stereo plug	1	2	3
3.5 3p stereo plug	1	2	3

NOTED:

1. CABLE : (0.1CU\*12+1.0PVC) X2C+0.1CU\*32B, OD3.8 BLACK COLOR, PVC JACKET.
2. CONNECTORS :  $\varnothing$ 3.5mm STEREO PLUG\*2PCS (Ni)
3. MOLD ASSEMBLY, BLACK COLOR
4. OPEN/SHORT TEST : 100% TEST.
5. RoHS COMPLIANT



LABEL

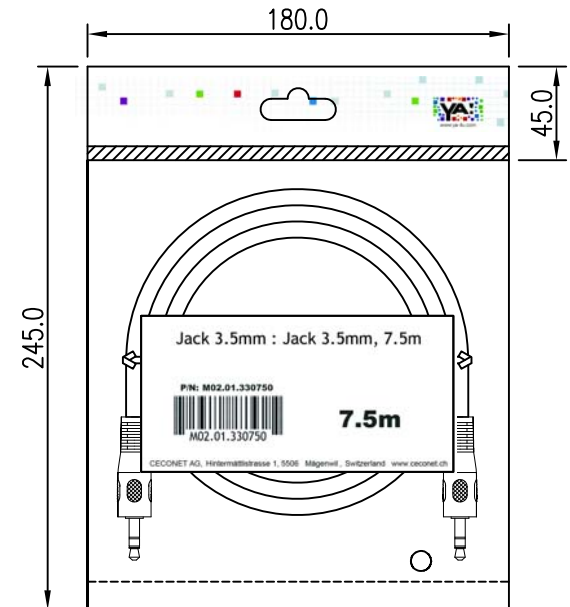

TOLERANCE		SCALE	SHEET	DRAWN BY	DATE
.X	±0.25	1 : 1	1 OF 1	Kevin	19/11/2018
		REV.		CHECKED BY	DATE
.XX	±0.10	A			
		MATERIAL		THIRD ANGLE PROJECTION	
ANGLES	±0.5°	-			

Jack 3.5mm : Jack 3.5mm  
7.5M

PART NO.	DWG NO.
M02.01.330750	-

