



# Interactive Touch Display

## User's Manual

i3TOUCH E1055 4K

i3TOUCH E1065 4K

i3TOUCH E1075 4K

i3TOUCH E1086 4K



i3-TECHNOLOGIES

## **Contents**

Safety Warning & Statements .....	1
Prepare to Install .....	2
Connection and Setting .....	7
Menu Operation .....	11
Simple Troubleshooting .....	14
Maintenance .....	15

## **Safety Warning**

### **Placement**

- Do not place the unit on an unstable cart, stand, tripod, bracket, table, or shelf.
- Do not expose the unit to direct sunlight and other sources of heat.
- Do not put the unit near appliances that generate magnetic fields.
- Do not put any liquid near or on the unit, make sure do not spill any liquid inside the unit.
- Do not put heavy objects on top of the unit.

### **Power Supply**

- Check that the unit's operating voltage is identical with your local power supply.
- Please unplug power supply and antenna plug when the weather is thunder-storm or lightning.
- Please unplug power supply, when there is nobody home or the unit will be in idle for a long time.
- Please keep power cable from physical or mechanical damage.
- Please use the original power cable from the accessory bag, don't modify or lengthen it.
- Please check and ensure AC source is connected with the ground.
- This power cable comes with the device exclusively for this device only.

### **LED Screen**

- Never use any other hard or sharp object to replace the touch pen.
- Unplug the power cable before cleaning.
- Clean the screen with a soft, dustless and dry cloth.
- Never use water or the spray type detergent to clean the unit.
- For deep clean, please contact an authorized service center.
- Better for the panel lifetime and the display performance, do not display high brightness image for long time.

### **Temperature**

- Do not place the unit near or over a radiator or a heater.
- If your unit is suddenly moved from a cold to a warm place, please unplug the power cable and do not turn it on at least 2 hours, making sure the moisture inside the unit is all evaporated.
- Normal operating temperature is 0 ~ 40 C .

### **Humidity**

- Do not expose the unit in rain, or place in high humidity area.
- Please make sure indoor environment is dry and cool. Normal operating humidity is 10%~90%RH.

### **Ventilation**

- Please put the unit in a well ventilated place, so the heating can be released easily.
- Ensure that the unit has enough space for ventilation. Space requirement: left, right and back >10cm, top > 20cm.

### **Earphone**

- Using the earphone to listen loud sound for a long time might effect the hearing.
- Before using earphone, please turn down the volume in advance.

### **Standby**

- It will enter standby mode but not turn off the unit after press the standby key.

### **Battery**

- Please make sure the battery get proper disposal or recycle after using.
- Please keep the battery away from kids and don't throw the battery into fire.

### **Notes for Cleaning**

- There are vents on back cover, please do not use any liquid or spray directly during cleaning.

### **Power Switch Status Signs**

- "I" means power on, "O" means power off.





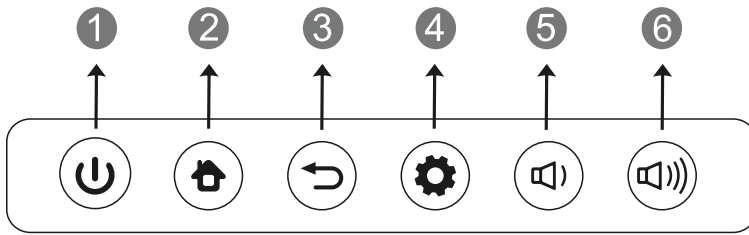

### **Notes for Maintenance**

- tive only. If there is inconsistency between the image and the actual product, the actual product shall govern.

## Prepare to Install

### 1. Control Panel



Items	Function description
① 	Tap to enter EnergySaving function Press at least 2 seconds to enter standby mode
② 	HOME button: back to main interface
③ 	Return button: return to previous level menu
④ 	Menu button: call up function menu
⑤ 	Volume down button: turn down volume
⑥ 	Volume up button: turn up volume

## 2. Terminal Interface

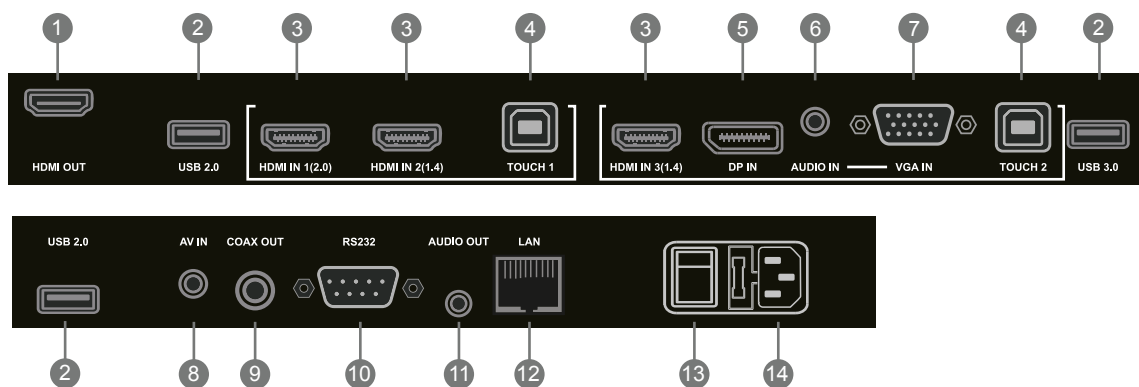







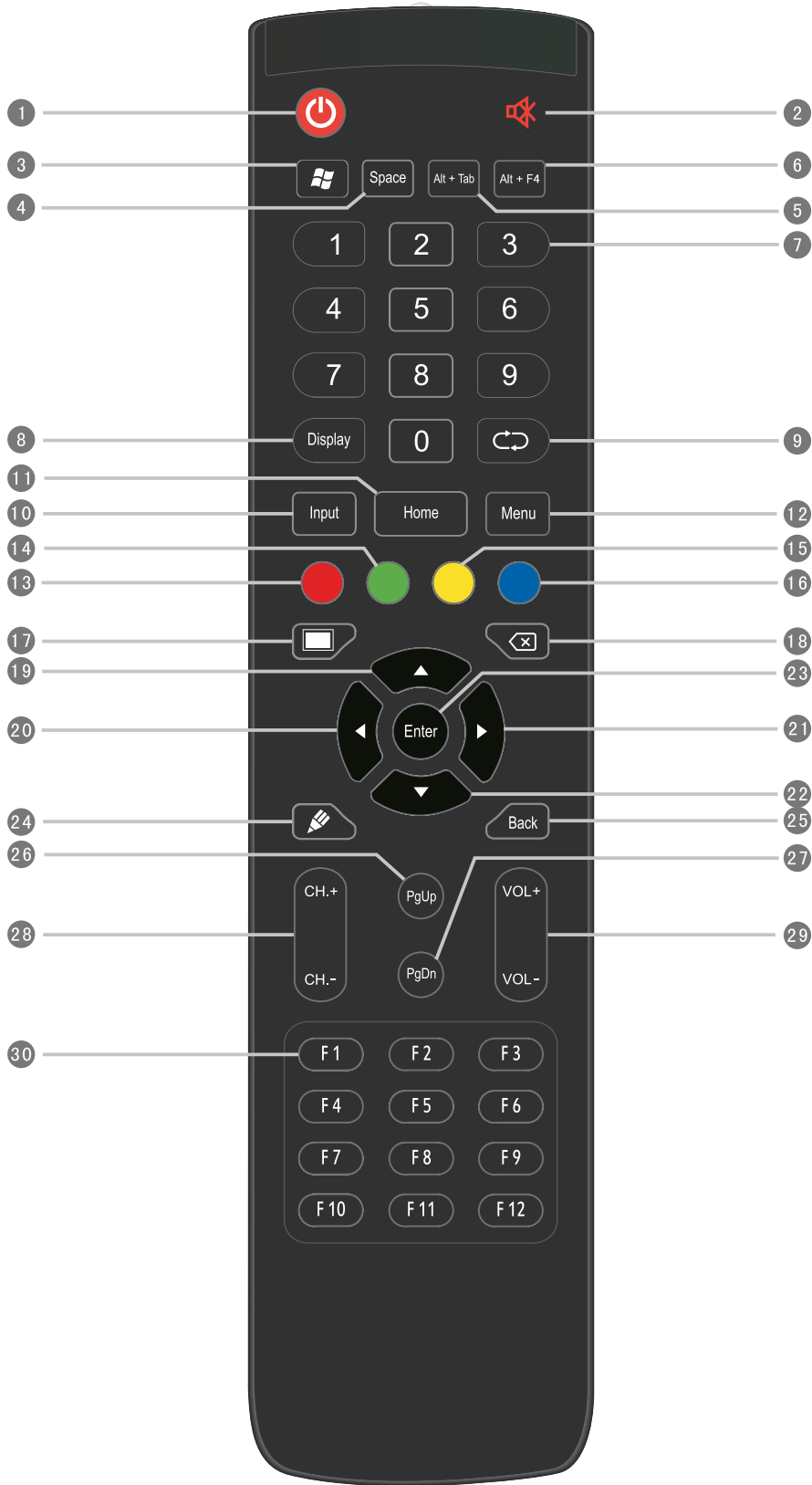



Items	Function description
① HDMI OUT	Connected to the devices with HDMI input function
② USB	Connect USB devices such as mobile hard disk, U disk, USB keyboard and mouse, USB drives, etc.
③ HDMI IN	High-definition multimedia interface signal input, connect to PC with HDMI output, set-top box, or other video device
④ TOUCH	Touch signal output to the external computer
⑤ DP	Connected to devices with DisplayPort output function
⑥ AUDIO IN	External computer audio input
⑦ VGA IN	External computer image input
⑧ AV IN	Composite video and audio input
⑨ COAX OUT	Coaxial output
⑩ RS232	Serial interface, used for mutual transfer of data between devices
⑪ AUDIO OUT	Audio output to the external speaker
⑫ LAN	Connecting RJ45 terminals
⑬ AC SWITCH	To open or shut down AC power supply. " I " means power on, " O " means power off
⑭ AC IN	AC power input, connecting AC power supply

### 3. Remote Control

#### 1) Remote control button instruction



## Detailed Function Description

1		Power on/off
2		Mute switch
3		Built-in computer Windows key
4	Space	Built-in computer Space key
5	Alt+Tab	Built-in computer spacebar Alt + Tab
6	Alt+F4	Built-in computer program window close button
7	Numeric keys:	Numeric input keys
8	Display:	Display channel information
9		Function button
10	Input:	Input signal source selection key, choose different sourced according to need
11	Home:	Android system main screen button
12	Menu:	Setting menu button, press this button to pop up
13	Red:	Lock and unlock Buttons and Touch function
14	Green:	Lock and unlock Buttons function
15	Yellow:	Lock and unlock Touch function
16	Blue:	Freeze and zoom
17		One key for blank screen
18		Backspace key
19		Direction key, press this button for upwards selection
20		Direction key, press this button for left selection
21		Direction key, press this button for right selection
22		Direction key, press this button for downwards selection
23	Enter:	Confirmation key, press this key to confirm selection state
24		Quickly start writing software
25	Back:	Return key
26	PgUp:	Built-in computer page (previous page)
27	PgDn:	Built-in computer page (next page)
28	CH.+ \ CH-:	Function button
29	VOL+ \ VOL-:	Volume switch key
30	F1-F12:	Built-in computer F1 - F12 function keys

NOTE: In case of no built-in computer, all function keys related with computer are regarded as no operating functions.

2) Remote Control Instruction

**Install Batteries**

- (1) Open back cover of battery component on the back of remote control
- (2) Install AAA type battery according to the corresponding electrode, make sure battery positive and negative pole are correct ("+"to"+"", "-" to "-"), please do not mix using old and new batteries
- (3) After battery is installed, close the back cover of battery components, and make the following clip buckled to the bottom

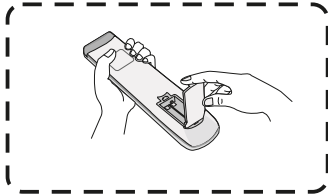

(1)

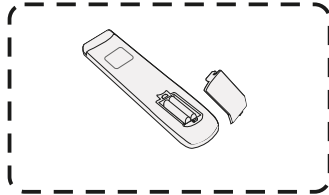

(2)

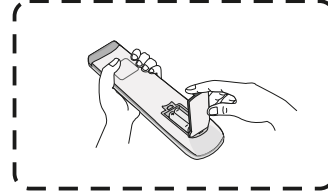

(3)

**Range of remote control**

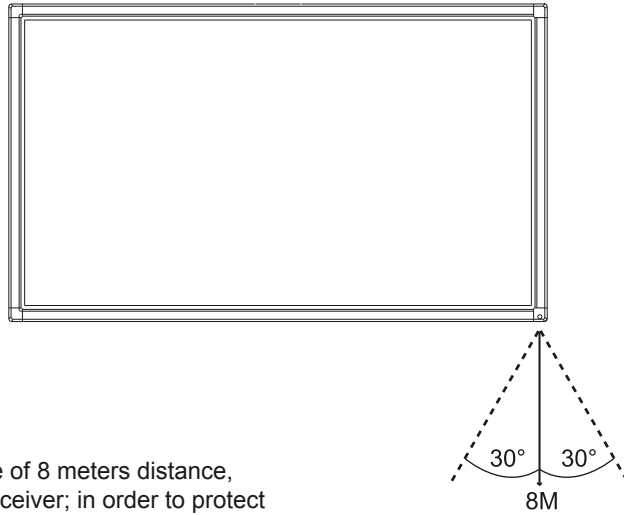

Remote control can work normally within the range of 8 meters distance, 30 degrees left and right from the remotecontrol receiver; in order to protect environment, please dispose waste battery into recycling box.



If the batttery is replaced by an incorrect type, it may lead to explosion.

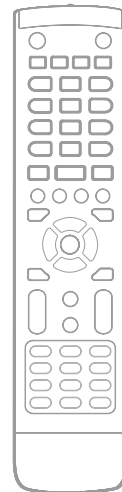





## Connection and Setting

 For the safety of you and the machine, please do not connect any power plug before connection.

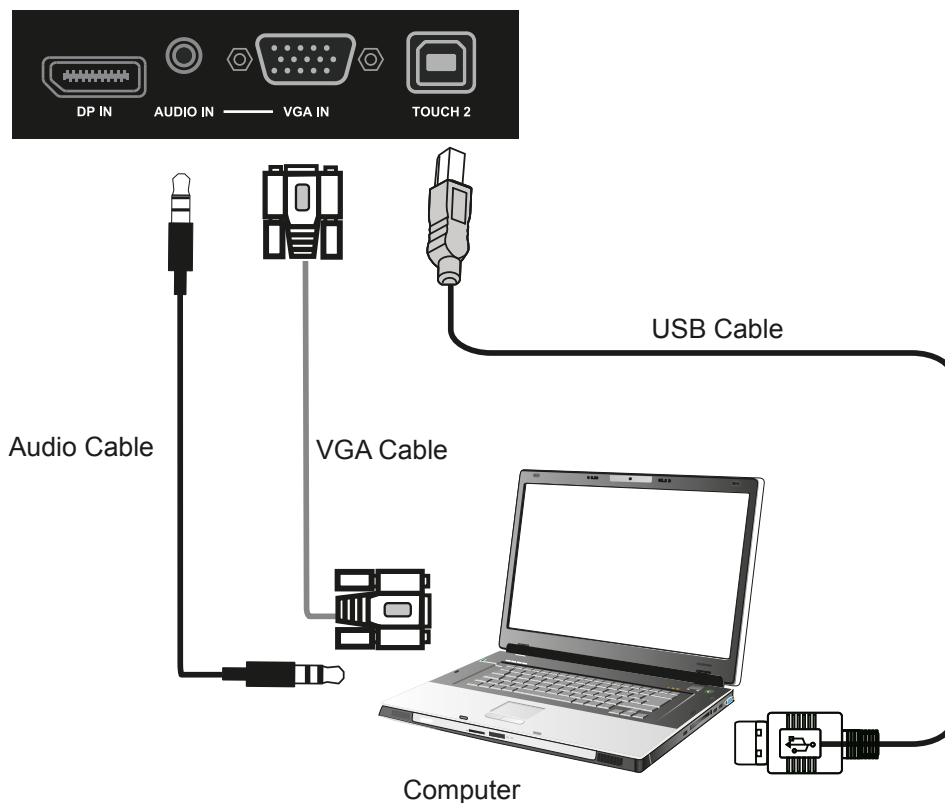
### 1. External Computer and Touch Connection



- (1) Use VGA cable to connect to VGA output port of external computer, and meanwhile use headphone audio cable to connect to external computer audio output interface
- (2) Use USB cable to connect to external computer USB port
- (3) After cable connection, plug in power cord, and switch power on
- (4) Start external computer
- (5) Press  key, and the equipment is power on
- (6) Press the INPUT key to switch to VGA channel



#### NOTE:

External computer input, equipment's best resolution is 1920 x1080

External computer can also connect to the equipment through the HDMI cable

#### • Recommended computer configuration:

2.0GHz Processor, 1GB Memory

More than 256 color display card

1GB Available Hard Drive

Support Resolution 800\*600,1024\*768,1920\*1080

VGA-OUT/HDMI-OUT、Audio-OUT、USB Interface

## 2. Audio and Video Equipment

### 1) AV IN

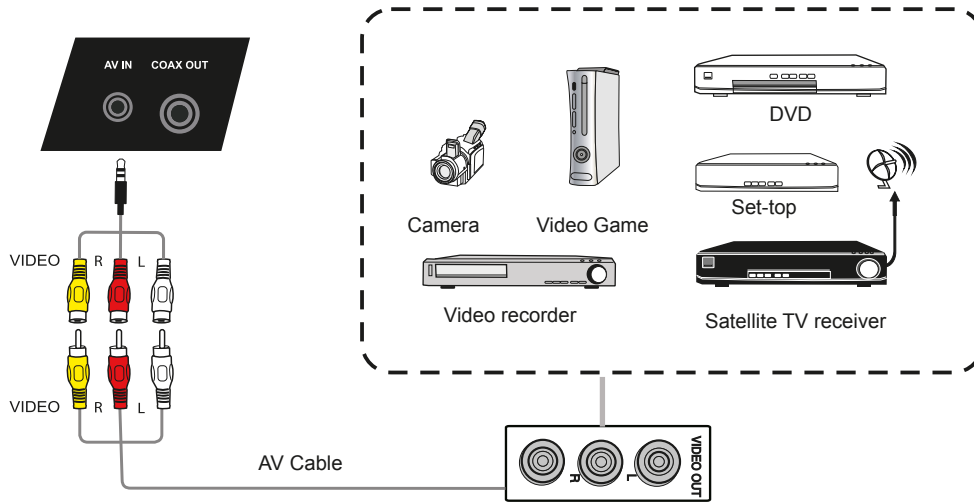

- (1) Use AV audio and video cables to connect audio and video equipments with AV output (yellow for video, red for right sound channel, and white for left sound channel)
- (2) After cable connection, plug in power cord, and switch power on
- (3) Press  to turn equipment on
- (4) Press INPUT key to switch to AV port

### 2) HDMI

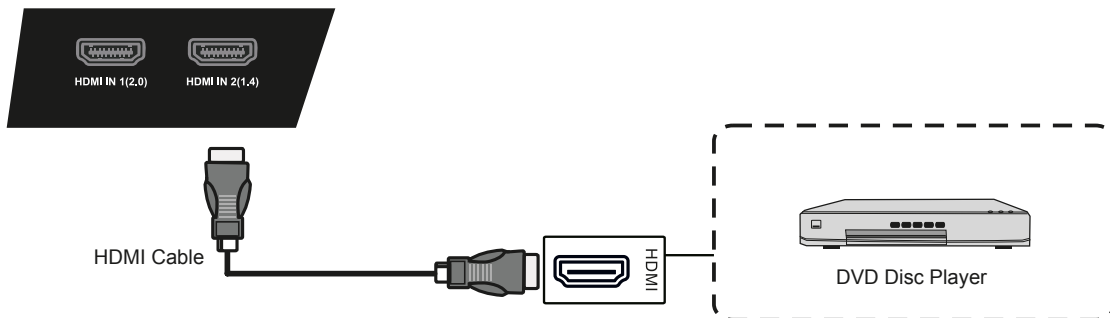

- (1) Use HDMI cable to connect audio and video equipment with HDMI output
- (2) After cable connection, plug in power cord, and switch power on
- (3) Press  to turn equipment on
- (4) Press INPUT key to switch to HDMI port

### 3. Coaxial Connection

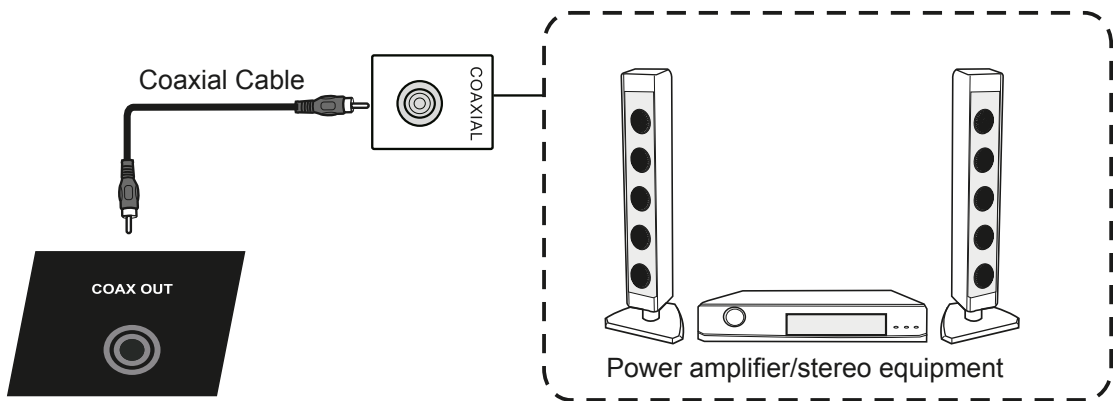

- (1) Use coaxial cable to connect audio device with coaxial input
- (2) After cable connection, plug in power cord, and switch power on
- (3) Press  to turn equipment on

### 4. Video Output Connection

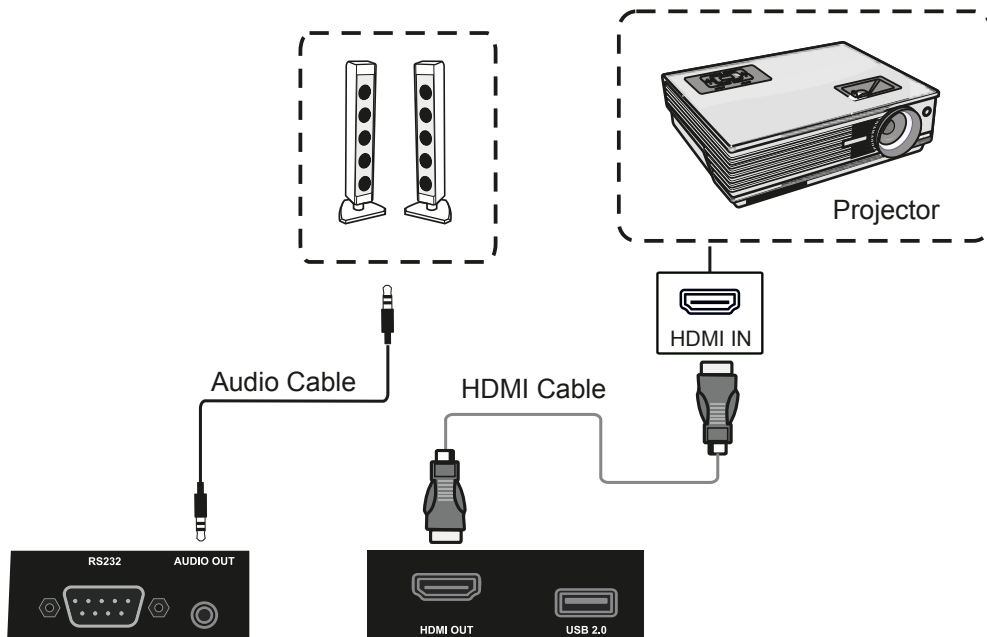

- (1) Use HDMI cable to connect display devices with HDMI in, and use audio cable to connect sound output
- (2) After cable connection, plug in power cord, and switch power on
- (3) Press  to turn equipment on
- (4) Press INPUT key to switch to HDMI port

### 5. LAN Connection

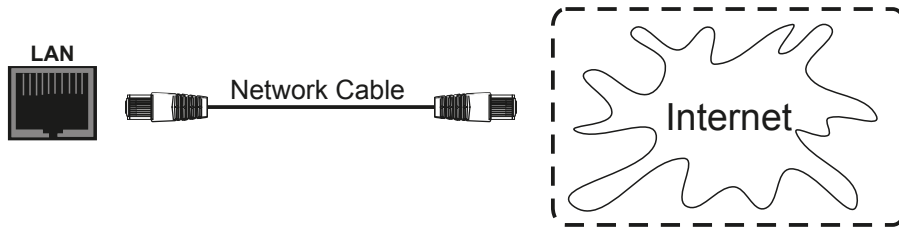

### 6. RS232 Connection

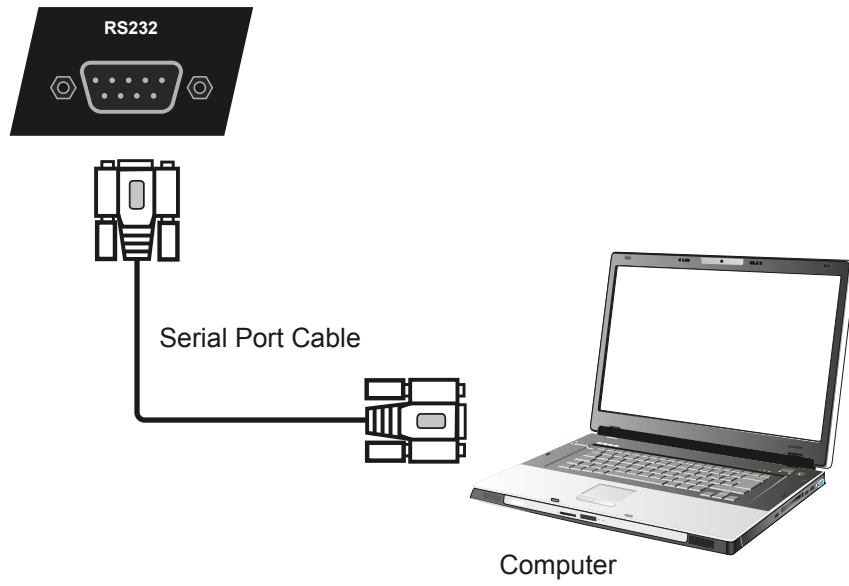

After using serial port cable to connect central control equipment and machine, certain function of the machine can be controlled via central control equipment, such as: machine ON/OFF, and adjustment of sound volume, etc.

## Menu Operation

### Touch Menu Operation

#### Call up Method

Take middle point position on the bottom of display screen as starting point, use touch pen to drag towards screen center position to call up touch menu, as shown below.

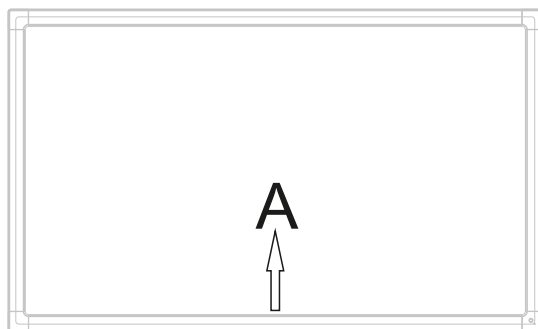

Note: "Touch A Method" mentioned in this manual to call up touch menu method is shown above.

## Setting Menu

### General Setting

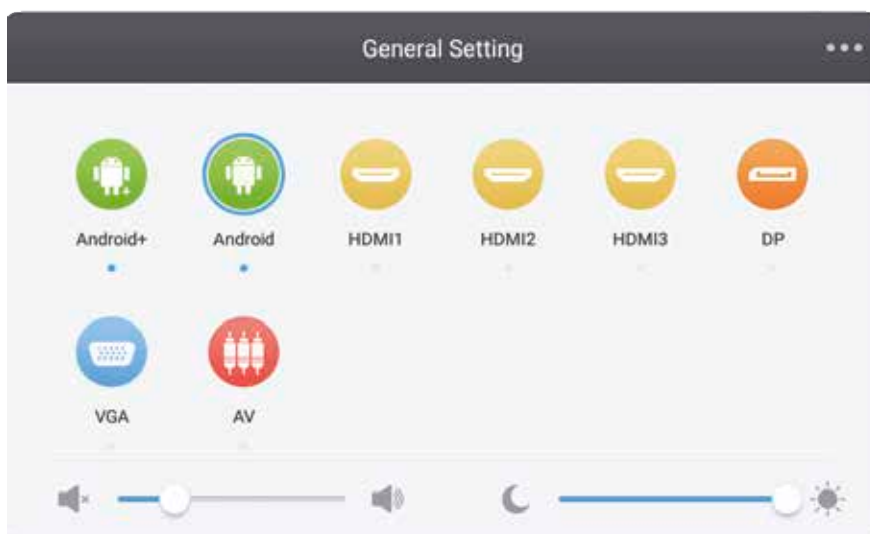

- Press INPUT button on remote control or via touch A method to call up General Setting menu.
- Press ▼/▲/◀/▶ button on remote control to select the channel you need.
- Press the Enter button on remote control or directly click with touch pen to confirm selected input channel.
- Press return key on remote control, or click blank area outside menu with touch pen to exit menu.







Note: PC channel will only display when the equipment connect the built-in computer.  
Android channel will only display when the equipment connect the bulit-in Android module.

## Detail Setting Menu

- Press Menu on remote control or click the icon  on General Setting menu with touch pen to call up detail setting menu. Detail setting menu includes Audio, Screen, Display and Adjust.





### Audio



- Press  button on remote control to select Audio setting menu.
- Press /// button on remote control or directly click with touch pen to select the option.
- Press Enter on remote control to enter adjustment mode, and press / button or directly click with touch pen to adjust each option. Press Enter/Back to exit adjustment.
- Press Mute on remote control or directly click with touch pen to open or close mute state.
- Press Back on remote control, or click blank area outside menu with touch pen to exit menu.

### Screen



- Press  button on remote control to select Screen setting menu.
- Press /// on remote control or directly click with touch pen to select the option.
- Press Enter on remote control or directly click with touch pen to enter the selected mode.
- Press Back on remote control, or click blank area outside menu with touch pen to exit menu.

## Display



- Press ► button on remote control to select Display setting menu.
- Press ▼/▲/◀/▶ button on remote control or directly click with touch pen to select the option.
- Press Enter on remote control to enter adjustment mode, and press ◀/▶ button or directly click with touch pen to adjust each option. Press Enter/Back to exit adjustment.
- Press Back on remote control, or click blank area outside menu with touch pen to exit menu.

## Adjust



- Press ► button on remote control to select Adjust setting menu.
- Press ▼/▲/◀/▶ button on remote control or directly click with touch pen to select the option.
- Press Enter on remote control to enter adjustment mode, and press ◀/▶ button or directly click with touch pen to adjust each option. Press Enter/Back to exit adjustment. You can also click the “Auto” icon to adjust automatically.
- Press Back on remote control, or click blank area outside menu with touch pen to exit menu.

## Simple Troubleshooting

### Machine fails to work normally

Remote control failure	<ol style="list-style-type: none"> <li>1. Check whether there are other objects between remote control and equipment control receiving window, thus leading to failure of remote control.</li> <li>2. Check whether the battery electrode in the remote control is correct.</li> <li>3. Check whether remote control needs to replace battery.</li> </ol>
Machine automatically shut down	<ol style="list-style-type: none"> <li>1. Whether set sleep or not.</li> <li>2. Check whether there is sudden power outage.</li> <li>3. Check whether there is no signal automatic shutdown.</li> </ol>

### PC mode

Signal out of range	<ol style="list-style-type: none"> <li>1. Check whether display is set correctly</li> <li>2. Check whether resolution is the best resolution.</li> <li>3. Adjust line and field synchronization in menu.</li> </ol>
Background has vertical lines or streaks	<ol style="list-style-type: none"> <li>1. Select automatic correction in menu.</li> <li>2. Adjust clock and phase position in menu.</li> </ol>
Image lack of color, color is incorrect	<ol style="list-style-type: none"> <li>1. Check whether VGA is not well connected or has quality problem.</li> <li>2. Adjust chromaticity and brightness or contrast in menu.</li> </ol>
Display format that is not supported	<ol style="list-style-type: none"> <li>1. Select automatic correction in menu.</li> <li>2. Adjust clock and phase position in menu.</li> </ol>

### Touch Function

Touch function invalid	<ol style="list-style-type: none"> <li>1. Check whether touch driver is installed and started.</li> <li>2. Check whether the size of article touched is comparable with finger.</li> </ol>
Touch positioning not correct	<ol style="list-style-type: none"> <li>1. Check whether driver is properly installed and make correction.</li> <li>2. Check whether touch pen is facing the screen.</li> </ol>

### Video function can't work normally

No picture and no sound	<ol style="list-style-type: none"> <li>1. Check whether the machine is started state.</li> <li>2. Check whether signal wire is well plugged, whether INPUT is corresponding to it.</li> <li>3. If in internal computer mode, check whether internal computer is started.</li> </ol>
With horizontal or vertical stripes or image dithering	<ol style="list-style-type: none"> <li>1. Check whether signal wire is well connected.</li> <li>2. Check whether other electronic equipment or power tools are placed around the machine.</li> </ol>
No color, color is weak or image is weak	<ol style="list-style-type: none"> <li>1. Adjust chromaticity and brightness or contrast in menu.</li> <li>2. Check whether signal wire is well connected.</li> </ol>

### Audio function can't work normally

With image but without sound	<ol style="list-style-type: none"> <li>1. Check whether mute button is pressed for mute.</li> <li>2. Press VOL + / - to adjust volume.</li> <li>3. Check whether audio line is connected correctly.</li> </ol>
Only one speaker has sound	<ol style="list-style-type: none"> <li>1. Adjust sound balance in menu.</li> <li>2. Check whether computer sound control panel only sets up one sound channel.</li> <li>3. Check whether audio line is connected correctly.</li> </ol>
VGA output without sound	<ol style="list-style-type: none"> <li>1. Check whether connect external device with headphone cable.</li> </ol>



## Maintenance

Proper maintenance can avoid many early faults and regular careful cleaning can make machine brand new. Please unplug power plug before cleaning and maintenance, to prevent electric shock.

### Clean screen

Please mix and stir even a little fabric softener or tableware detergent with warm water.

Please use a soft cloth to be completely soaked in the mixture.

Please take out cloth and twist to half dry state to wipe machine screen.

Repeat for several times, pay attention not to squeeze water flow into machine when wiping machine.



### Clean face frame

Please use dry, soft, lint-free cloth to wipe front frame.

### No use of machine for a long time

In case of no use of machine for a long time, such as holiday, please make sure to unplug the plug to prevent any possible dangers caused by power supply ripple from lightning.

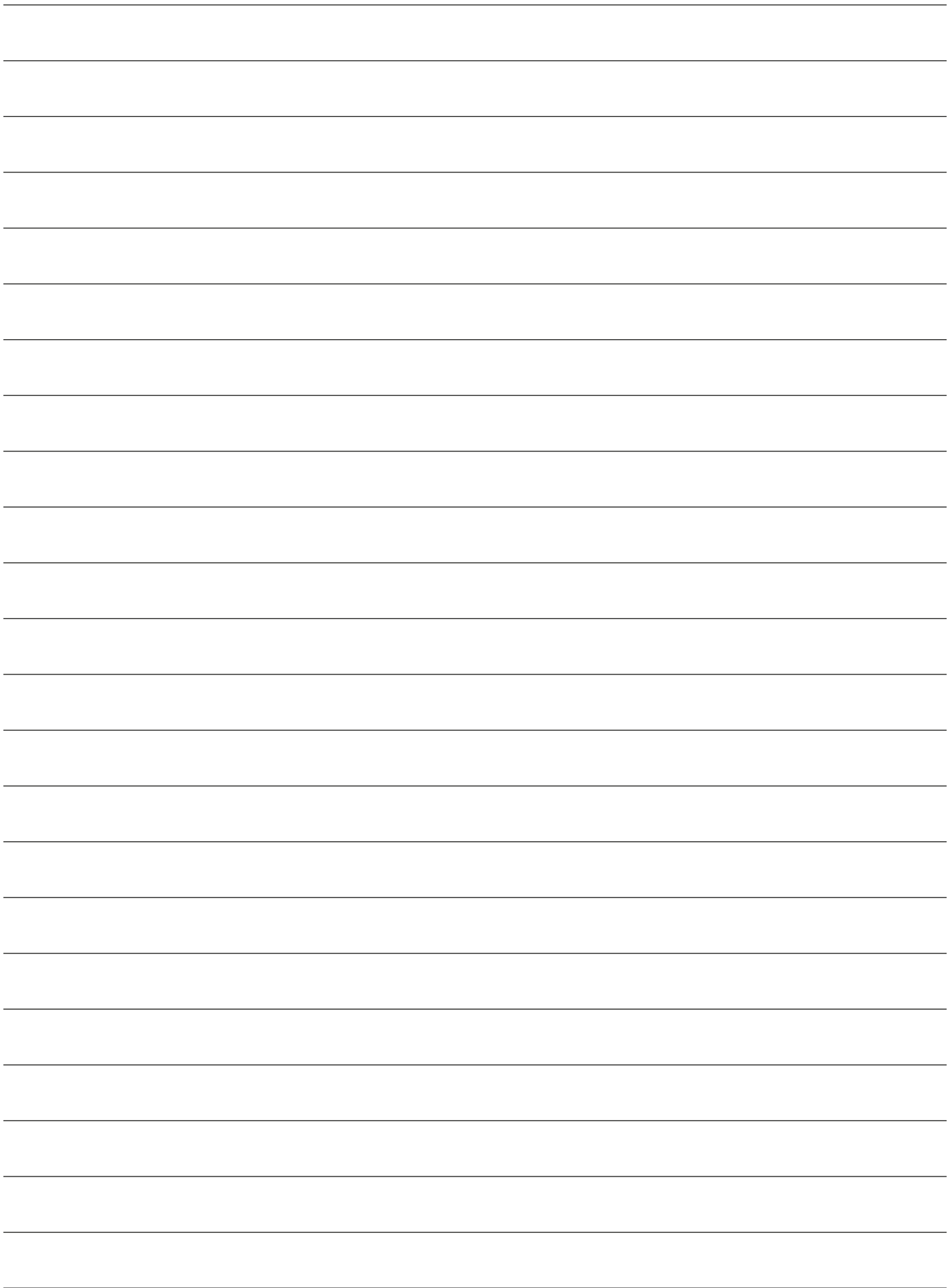

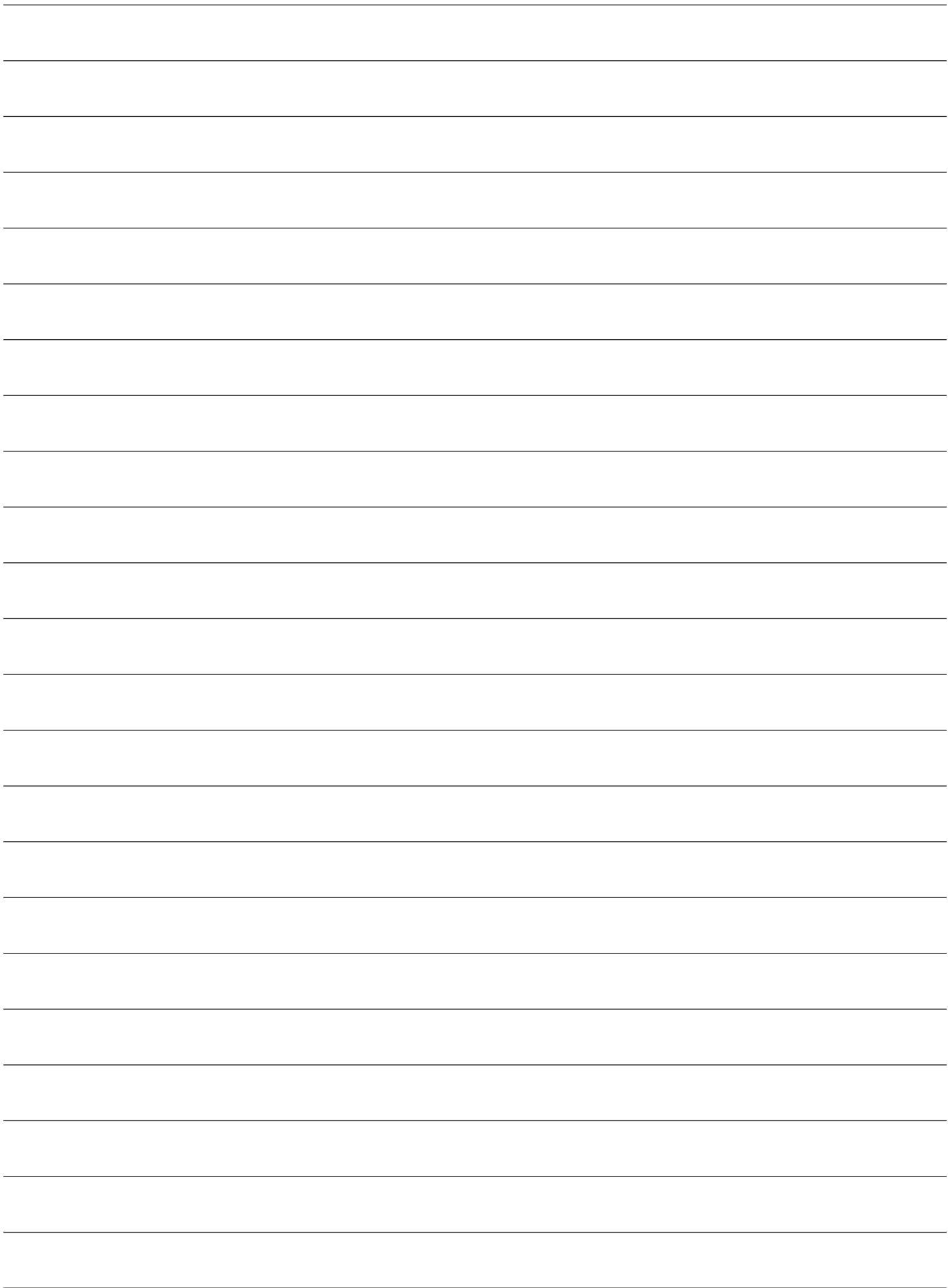

AUTHORISED RESELLER



i3-TECHNOLOGIES

[WWW.I3-TECHNOLOGIES.COM](http://WWW.I3-TECHNOLOGIES.COM)  
[INFO@I3-TECHNOLOGIES.COM](mailto:INFO@I3-TECHNOLOGIES.COM)