

NOTES :  
 3840\*2160@60Hz  
 Support 18Gbps 4:4:4  
 Support 100M

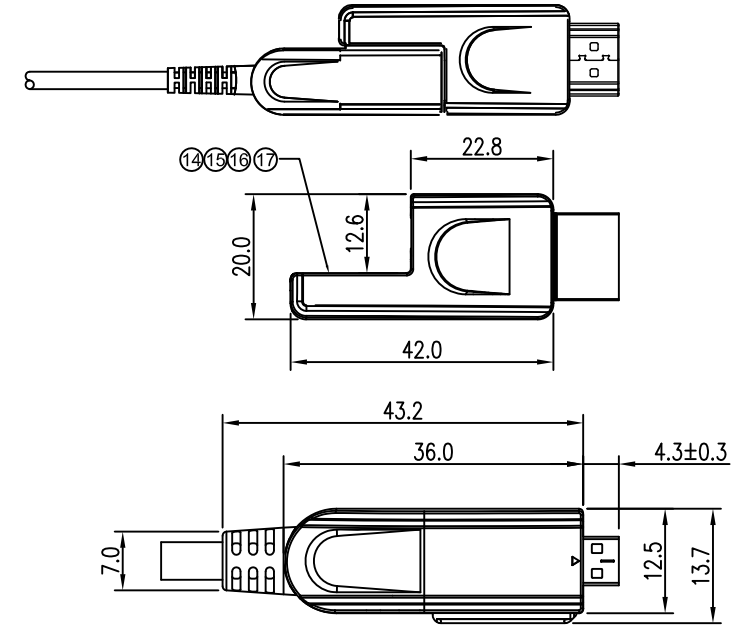

10	Spring Lock	1	PCS				
9	SR Black	1	PCS				
8	HDMI D Male PCBA (Display)	1	PCS	18	Screw	2	PCS
7	HDMI A male Shell(Upper) Siliver	1	PCS	17	HDMI A Male Adapter Shell(Upon)Grey	1	PCS
6	HDMI A male Shell(Bottom) Siliver(Source) (Source)	1	PCS	16	HDMI A Male Adapter Shell(Bottom)Grey	1	PCS
5	Screw	2	PCS	15	HDMI A Male Adapter PCBA	1	PCS
4	Spring Lock	1	PCS	14	HDMI A Male Gold Plated Blue Core	1	PCS
3	SR Black	1	PCS	13	HDMI D Male Shell (Bottom)Grey(Display)	1	PCS
2	HDMI A male PCBA (Source)	1	PCS	12	HDMI D Male Shell(Upon) Grey	1	PCS
1	HDMI AOC (4 Fiber+7 Copper) Black CPR OD:4.5MM	TABLE A	mm	11	Screw	2	PCS
ITEM	SPECIFICATIONS	Q' TY	UNIT	ITEM	SPECIFICATIONS	Q' TY	UNIT

TOLERANCE		SCALE	SHEET	DRAWN BY	DATE
.X	±0.25	1 : 1	1 OF 1	Kevin	30/08/2019
		REV.		CHECKED BY	DATE
.XX	±0.10	A			
		MATERIAL		THIRD ANGLE PROJECTION	
ANGLES	±0.5°	-			

<b>HDMI 2.0 AOC A-D</b> <b>4K60Hz 18Gbps,30m</b>	
PART NO.	DWG NO.
M01.30.12.03000	-

