



Avonic PTZ Camera 20x/12x/30x zoom

CM70-IP / CM71-IP / CM73-IP

CONTENTS

Introduction.....	4
Contact	4
Join Avonic	4
Safety Notes	4
Package contents and Accessories	5
Contents.....	5
Handling precautions	5
Accessories	5
Product Overview.....	6
Features	6
Installation	7
Connections	7
System Select Switch.....	8
RS232 Interface.....	8
RS232 network connection diagram	9
RS485 network connection diagram	9
IP network connection diagram.....	9
Operation.....	10
Remote controller	10
Other Key Combinations	12
OSD Menu	13
Serial Communication Control	18
IP Control.....	18
WebGUI.....	19
Login.....	19
Local.....	19
Audio	20
Video	21
Network.....	27
System	29
Maintenance	33
Camera Maintenance	33
Unauthorized Use	33

Troubleshooting	33
General Advice	33
Power Issues	33
Image.....	34
Control	34
WebGUI.....	34
VISCA command list	35
VISCA over IP commands	35
Appendix B Dimensions	45

INTRODUCTION

Thank you for your Avonic purchase. Before beginning to operate this device, please read the manual in order to make sure the best performance is obtained. Save this manual for future reference.

Contact

For any questions or suggestions, contact your reseller or the local distributor of Avonic. Find the local distributor on the website of Avonic. For the most recent version of the manual or datasheet, look at the Avonic website: www.avonic.eu

Join Avonic



facebook.com/avonicPTZ



linkedin.com/company/avonic



twitter.com/avonic

Safety Notes

- Installation and servicing should only be done by Qualified Service Personnel and conform to all local codes.
- This unit is designed for indoor use only and it must not be installed where exposed to water or other liquids and moisture.
- Before powering on the device, check the input power voltage carefully.
- Avoid shock and vibration when transporting and installing the device.
- Electronic devices produce heat. Do not block the ventilation slots of the device and make sure the installation environment is well ventilated to avoid overheating.
- Before cleaning, unplug the power cable. Use a soft, damp cloth to clean the device, do not use strong or abrasive detergent to clean that will damage the device.
- If you wish to dispose this product, please contact Avonic to obtain info about the disposal procedure.

PACKAGE CONTENTS AND ACCESSORIES

Contents

Quantity	Description	Avonic SKU
1 pc	PTZ Camera	AV-CM70/71/73-IP-B/W
1 pc	Power Supply 12V/A	AV-CM40-PSU
1 pc	Remote Control	AV-CM40-RC
1 pc	USB cable type A to type A	AV-USB20-AA
1 pc	RS232 9-pin male to 8-pin male	AV-CM-RS232
1 pc	2-way RS485 serial connector	AV-PHNX-2
1 pc	5-way Balanced audio conn.	AV-PHNX-5

Handling precautions

Be cautious to take the camera by its base. When placing back the camera in its protective foam, be sure the lens is in horizontal position.

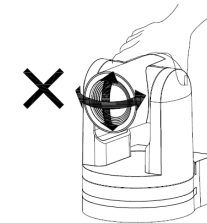
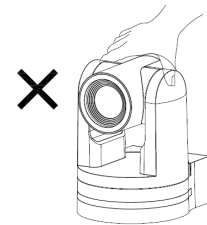

Accessories



Ceiling mount
SKU white: CM-CMW
SKU black: CM-CMB



Wall mount
SKU white: CM-WMW
SKU black: CM-WMB



Wall and Ceiling mount
SKU white: AV-MT200-W
SKU black: AV-MT200-B

PRODUCT OVERVIEW

The Avonic CM70 series is a high quality PTZ camera line with simultaneous HDMI, 3G-SDI, USB 2.0 and IP stream ethernet outputs. The cameras are designed for fixed installations in less than optimal light conditions. The CM70 series includes a rich featureset usually found on broadcast-grade cameras, including a user-adjustable Colour Matrix and SRT streaming (licensed premium functions). The CM70 series has the ability to deliver outstanding quality under low light conditions, thanks to its high SNR CMOS sensor. The sensor delivers Full HD 1080p60 video

Features

- Panasonic high-quality 1/3 inch, 2.12 million effective pixels HD CMOS sensor
- Output frame rate up to 60fps in 1080P
- 20x/12x/30x Optical Zoom, glass lens.
- Remote Control Using RS232/ RS485/ IP/ IR/ USB interface, all the parameters of the camera can be remotely controlled.
- Leading autofocus algorithm for a fast, accurate and stable auto-focusing lens.
- Low noise and High SNR: Low Noise CMOS effectively ensures high SNR of the camera.
- Advanced 2D/3D noise reduction technology is also used to further reduce the noise while ensuring image sharpness.
- High accuracy, silent step driving motor makes for accurate fast and quiet panning and tilting, in High Speed Mode <math><100^\circ \text{ p/s}</math> pan speed and <math><70^\circ \text{ p/s}</math> tilt speed
- Multi-Format Video Outputs: HDMI 1.4a, 3G-SDI, USB2.0, ethernet
- Ethernet port with PoE functionality
- Tally Light functionality for on-air indication (licensed premium feature)
- High Speed Mode; upgraded Pan and Tilt speed
- Encrypted SRT streaming (licensed premium feature)
- Fully customizable RGB colour matrix for perfect integration with other cameras (licensed premium feature)
- The 3G-SDI is available for 100m transmission at 1080p60 format (SMPTE 424M). The output image is 8-bit YCbCr 4:2:2 level B (SMPTE 425M).
- Auto-Flip function
- Low-power sleep function: power consumption less than 500mW in standby mode.
- Supports multiple Control Protocols: VISCA OVER IP, Onvif, VISCA, PELCO-D, PELCO-P; protocols which can also be automatically recognized.
- Kensington Lock

INSTALLATION

Connections



1. Kensington Lock
2. Balanced Audio Line in 5-pin Phoenix connector
3. RS-485 two-wire serial communication with 2-pin Phoenix connector
4. System Selector (see Installation for more details)
5. RS-232 mini-DIN-8 IN (connect the supplied RS-232 cable)
6. RS-232 mini-DIN-8 OUT for daisy chaining RS-232 connection
7. 3G-SDI video output SMTPE 425M level B compliant
8. HDMI Type A
9. USB2.0 Type A, UVC video output and control
10. RJ45 Ethernet connection, with PoE
11. DC12V power with locking screw (connect the supplied DC PSU)
12. Power ON/OFF
13. Fall protection eye

System Select Switch

	0	1080p60	8	720p30
	1	1080p50	9	720p25
	2	1080i60	A	1080p59.94
	3	1080i50	B	1080i59.94
	4	720p60	C	720p59.94
	5	720p50	D	1080p29.97
	6	1080p30	E	720p29.97
	7	1080p25	F	Via OSD/Webgui

CAUTION:

- After changing the switch, you need to restart the camera to take effect.
- 720p30, 720p29.97 and 720p25 not supported by the SDI output.
- There are four ways to select the video output (via OSD, direct button combination on the remote control, via the webgui or via the rotary dial) of the camera, but the rotary dial takes priority after a reboot, except on setting F where all the outputs are defined digitally

Power adapter

This product is equipped with a 12V/2A DC power supply. Insert the power supply according to the requirements, turn on the power switch. Alternatively use a PoE ethernet connection, the Power switch on the back of the camera needs to be switched to the 'ON' position.

Power On

Pan-Tilt will rotate to the maximum position of top right after the camera started, then it returns to the center, the process of initialization is finished. The camera will show its current IR-channel setting and IP Address on the osd (Note: If the position preset 0 has been stored, the position preset 0 will be called after initialization). From this point onwards the user can control the camera with RC, Serial, USB or IP Communication.

RS232 Interface

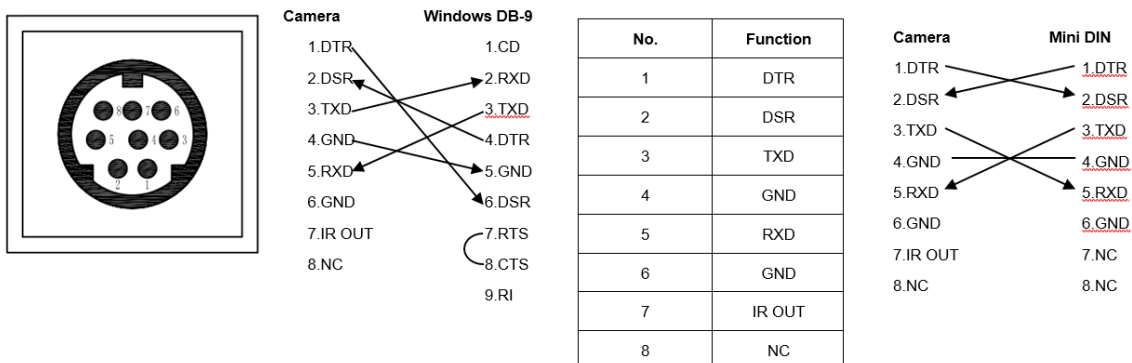

RS232 network connection diagram

When connecting multiple cameras through RS-232, use daisy chaining network architecture. Max cable length for RS-232 is 10-15m.

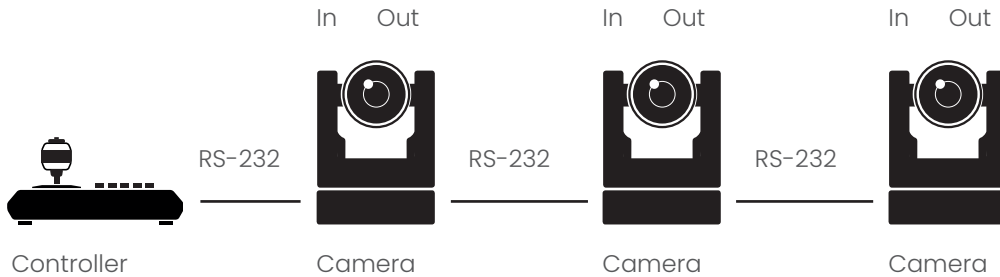

RS485 network connection diagram

To connect multiple cameras by RS485, the cameras are attached to a 2-wire twisted pair bus (max length 1200m) that is terminated at both ends with a 120 Ω impedance resistor. The maximum distance from the bus to the camera or controller is 5m.

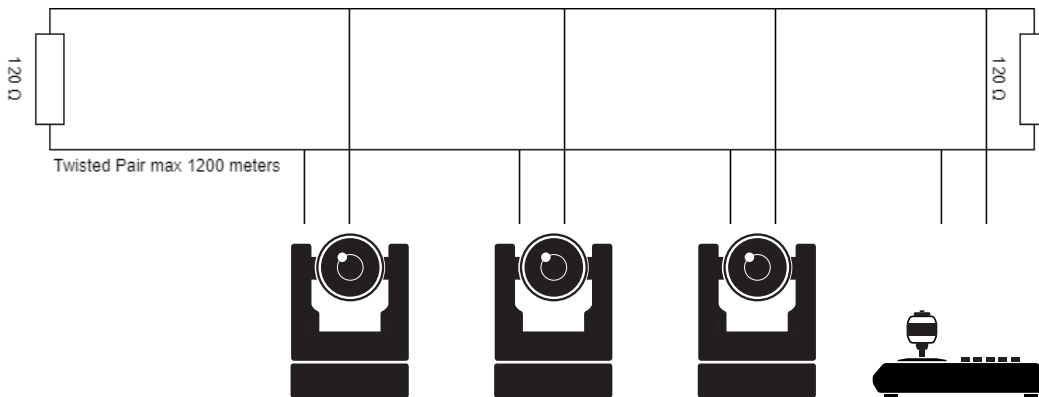

IP network connection diagram

Connect an Avonic PoE camera to a LAN using a standard (PoE) switch, if the unit is simultaneously connected to both PoE and its own power supply, the power supply will take priority. If the power supply is disconnected when PoE is present, the camera will remain operational without interruption.

Addressing is done via IP, the Visca address in a Visca over ip environment is always 1.

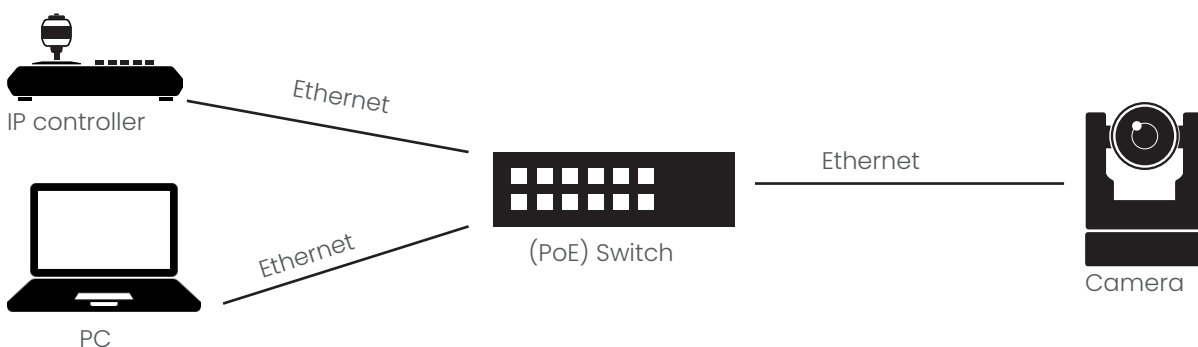

OPERATION

Remote controller



a. Power

Press the power button to turn on the camera. If the position preset 0 has been stored, the position preset 0 will be called after initialization. Press the power button again to turn the camera off, it will turn to the back when turned off, this is called the "privacy mode".

b. Set

This button has no function with this camera.

c. Camera select

Up to 4 different cameras can be controlled with 1 IR remote Control. With the camera select buttons [1,2,3,4] you can select the IR channel the remote control is using. The default camera IR channel is 1.

To control a camera on first use, please select camera 1 (IR channel 1) on the remote control. To control a second camera you first need to change the IR channel stored in the camera from 1 to 2.

- First turn off the other camera's in the room you don't want to change, to prevent that other camera's also get changed accidentally.
- Select camera 1 on the remote control, because the camera is still configured to listen to IR channel 1.
- Press [*]+[#]+[F2] to change the IR channel inside the camera to IR channel 2. The camera will confirm this on screen.
- Select camera 2 on the remote control to control this camera.

Key Combinations: (Default IR address is 1)

[*]+[#]+[F1]	: Camera Address No. 1	[*]+[#]+[F3]	: Camera Address No. 3
[*]+[#]+[F2]	: Camera Address No. 2	[*]+[#]+[F4]	: Camera Address No. 4

d. Number Keys

The number keys are used to call presets. Press the number [0-9] of the preset desired and the camera will respond accordingly (See 'h' on how to set & clear presets)

e. Focus +-

Push the button [manual focus] first before using the focus buttons. Focus the camera with the [+] and [-] button. If the camera does not respond check if the camera is set to auto-focus.

f. Auto/Manual Focus

Set the camera in auto-focus or manual-focus. If the camera is configured to auto-focus the buttons [Focus + -] are disabled. When the camera is in "manual focus" modus and the Zoom buttons are used, the camera automatically switches to auto-focus.

g. Zoom +-

Zoom the camera with these buttons. When the camera is in "manual focus" modus and the Zoom buttons are used, the camera automatically switches to auto-focus.

h. Set & Clear Preset

A preset is a specific position of a camera that you save into the camera. A preset is assigned to a number from 0-9. To set a preset first point the camera in a specific directing and a specific zoom position. Now assign the position to a number with the button "Set Preset". You can call the preset by pressing the number 0-9 on the remote control.

Set Preset:	[SET PRESET]+[<number>]
Call Preset:	[<number>]
Clear Preset:	[CLEAR PRESET]+[<number>]

If the position preset 0 has been stored, this position will be called after initialization.

i. PTZ keys (up/down/left/right)

Move the camera in a direction.

j. Home

Set the direction of the camera to a center position.

k. BLC (Back Light Control) ON/OFF

Change the Back light control setting.

l. Menu

The Menu button opens the "On Screen Display (OSD)" menu. This menu is visible on the HDMI/SDI/IP output. If the menu is not in English, please press [*]+[#]+[4] to change the Menu language to English.

m. Function Keys (F1/F2/F3/F4)

Used to configure the IR channel of the camera. See [c. Camera select] above for instructions.

n. Blank buttons

These buttons have no function with this camera.

Other Key Combinations

[*]+[#]+[4]	: Menu set to English
[*]+[#]+[6]	: Restore factory defaults
[*]+[#]+[9]	: Flip switch (just temporary flip to view the image flipped)
[*]+[#]+[Auto]	: Enter into the aging mode, only for quality control purposes
[*]+[#]+[Manual]	: Restore the default username, password, and IP address

[#]+[#]+[#]	: Clear all presets
[#]+[#]+[0]	: Switch the video format to 1080p60*
[#]+[#]+[1]	: Switch the video format to 1080p50*
[#]+[#]+[2]	: Switch the video format to 1080i60*
[#]+[#]+[3]	: Switch the video format to 1080i50*
[#]+[#]+[4]	: Switch the video format to 720p60*
[#]+[#]+[5]	: Switch the video format to 720p50*
[#]+[#]+[6]	: Switch the video format to 1080p30*
[#]+[#]+[7]	: Switch the video format to 1080p25*
[#]+[#]+[8]	: Switch the video format to 720p30*
[#]+[#]+[9]	: Switch the video format to 720p25*

***NOTE: THE CAMERA RETURNS TO THE VIDEO OUTPUT SETTING OF THE ROTARY DIAL AFTER A REBOOT**

OSD MENU

The OSD menu can be accessed by the Remote Control or an Avonic PTZ controller. In the following pages, the navigating is described for using the IR Remote Control.

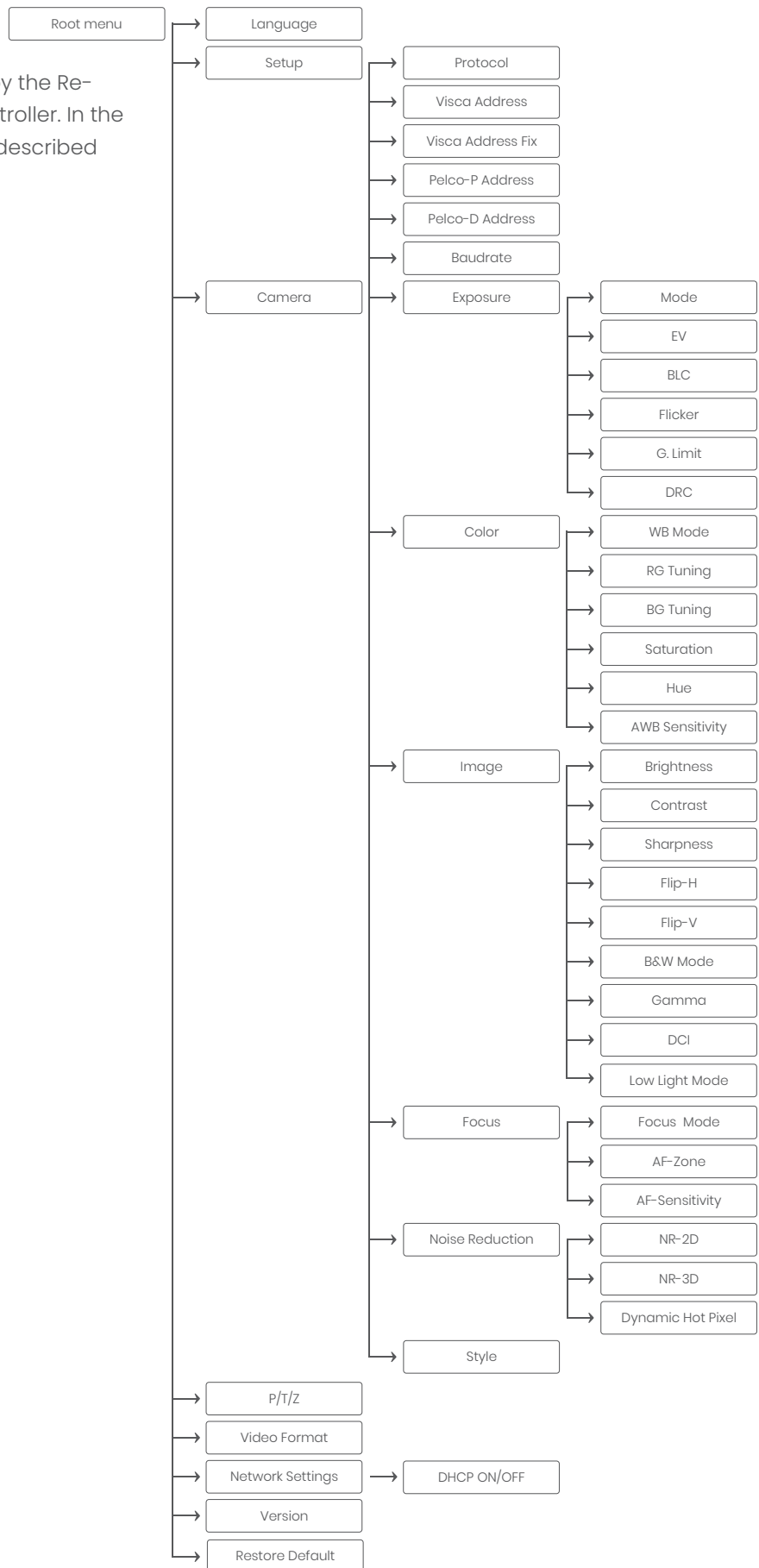

1. MENU

Press [MENU] button to display the main menu on the screen. Use the arrow buttons to move the cursor to the item to be set. Press the [HOME] button to enter the corresponding sub-menu. Press [◀▶] to change setting. Press [Menu] to go back

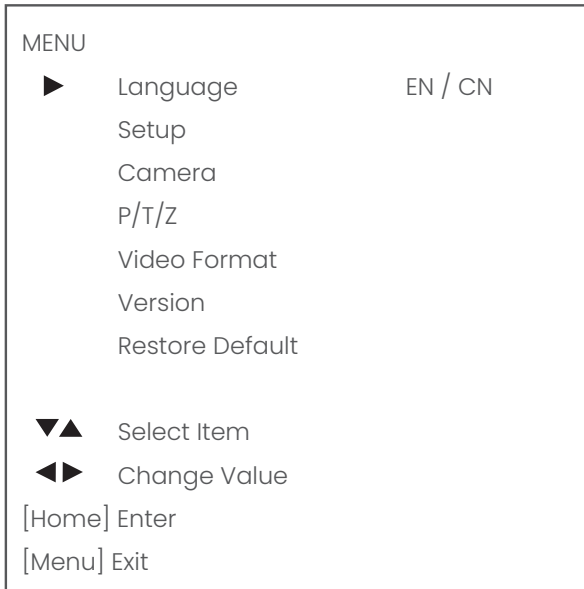

2. SETUP

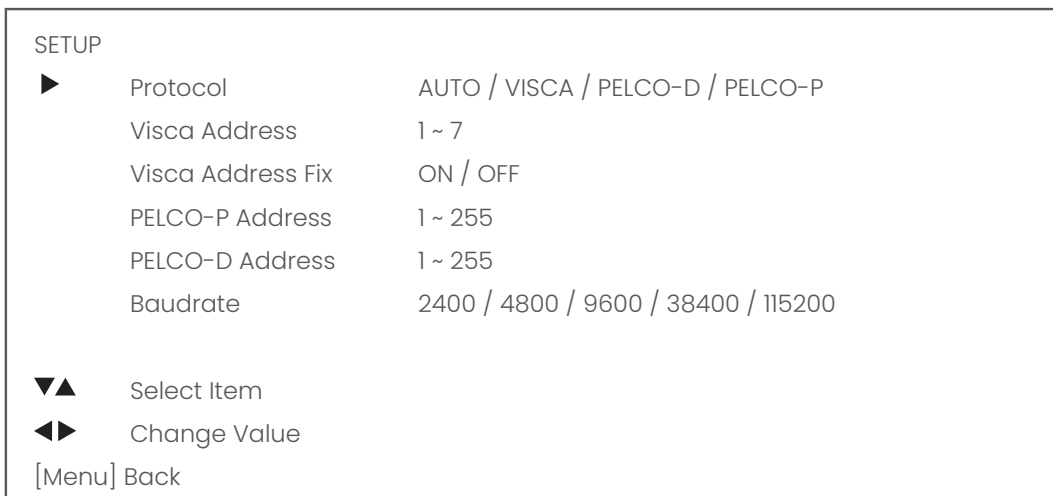

3. CAMERA

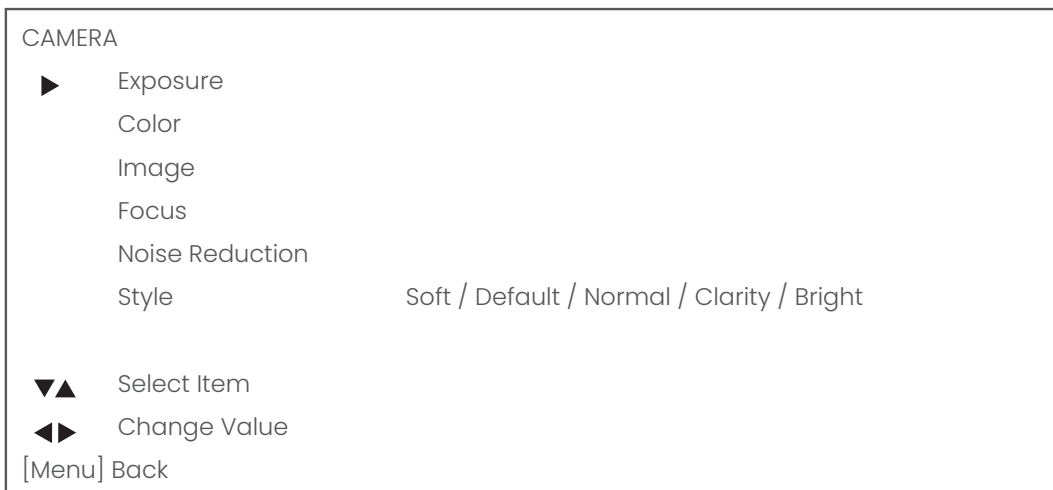

3.1 EXPOSURE

EXPOSURE	
▶	Mode Auto / Manual / SAE / AAE / Bright
	Iris F11 ~ F1.8 / CLOSE
	Shutter 1/25 ~ 1/10000
	EV ON / OFF
	EV Level -7 ~ +7
	BLC ON / OFF
	Flicker 50Hz / 60Hz / OFF
	G. Limit 0 ~ 15
	DRC 1 ~ 8 / CLOSE
▼▲	Select Item
◀▶	Change Value
[Menu]	Back

3.2 COLOR

COLOR	
▶	WB Mode Auto / 2400K ~ 7100K 100K increments / Manual / OnePush
	RG Tuning -10 ~ 10
	BG Tuning -10 ~ 10
	RG 0 ~ 255
	BG 0 ~ 255
	Saturation 60% - 200%
	Hue 0 ~ 14
	AWB Sensitivity Low / Middle / High
▼▲	Select Item
◀▶	Change Value
[Menu]	Back

3.3 IMAGE

The Flip function can be set, although the camera has an automatically flip function.

IMAGE		
▶	Brightness	0 ~ 14
	Contrast	0 ~ 14
	Sharpness	0 ~ 15
	Flip-H	ON / OFF
	Flip-V	ON / OFF
	B&W-Mode	Color / B&W
	Gamma	0.45 / 0.50 / 0.55 / 0.63 / Default
	DCI	1 ~ 8 / Close
	Low Light Mode	ON / OFF
▼▲	Select Item	
◀▶	Change Value	
[Menu] Back		

3.4 FOCUS

FOCUS		
▶	Focus Mode	Auto / Manual / OnePush
	AF-Zone	Top / Center / Bottom / All
	AF-Sensitivity	Low / Middle / High
▼▲	Select Item	
◀▶	Change Value	
[Menu] Back		

3.5 NOISE REDUCTION

NOISE REDUCTION		
▶	NR-2D	1 ~ 7 / Auto / OFF
	NR-3D	1 ~ 8 / Auto / OFF
	Dynamic Hot Pixel	1 ~ 5 / OFF
▼▲	Select Item	
◀▶	Change Value	
[Menu] Back		

3.6 STYLE

STYLE		
▶	Style	Default / Normal / Clarity / Bright / Soft
▼▲	Select Item	
◀▶	Change Value	
[Menu] Back		

4. PTZ

PTZ		
▶	Speed by Zoom	ON / OFF
	Zoom Speed	1 ~ 8
	Image Freezing	ON / OFF
▼▲	Select Item	
◀▶	Change Value	
[Menu]	Back	

5. VIDEO FORMAT

VIDEO FORMAT		
▶	Video Format	1080p60/ 1080p50/ 1080i60/ 1080i50/ 1080p30/ 1080p25/ 720p60/ 720p50/ 720p30/ 720p25/ 1080p59.94/ 1080i59.94/ 1080p29.97/ 720p59.94/ 720p29.97
▼▲	Select Item	
◀▶	Change Value	
[Menu]	Back	

6. NETWORK SETTINGS

▶	DHCP	ON/OFF
	IP Address	xxx.xxx.xxx.xxx
[Menu]	Back	

7. VERSION

VERSION			
▶	MCU Version	nr	date
	Camera Version	nr	date
	AF Version	nr	date
[Menu]	Back		

8. RESTORE DEFAULT

RESTORE DEFAULT		
▶	Restore default?	NO / YES
▼▲	Select Item	
◀▶	Change Value	
[Menu]	Back	
[Home]	OK	

Serial Communication Control

COM port settings

In default working mode, the camera is able to connect to a VISCA controller with an RS-232 or RS-485 serial interface.

The camera can be controlled via RS-232, the parameters of RS-232 are as follows:

- Baud rate: 2400/4800/9600*/115200
- Start bit: 1 bit.
- Data bit: 8 bits.
- Stop bit: 1 bit.
- Parity bit: none.

The camera can be controlled via RS-485, Half-duplex mode. The parameters are:

- Baud rate: 2400/4800/9600*
- Start bit: 1 bit.
- Data bit: 8 bits.
- Stop bit: 1 bit.
- Parity bit: none.

For command list, see Appendix A

* default value

IP Control

Network settings

By default the ip address of the camera is **192.168.5.163** with username and password **admin/admin**. Avonic IP cameras can be controlled by any device using the Visca over IP protocol (see command list Appendix A).

The control parameters for the CM4x and CM7x-IP cameras are as follows:

- IP Address: 192.168.5.163
- Username: admin
- Password: admin
- TCP or UDP port: 1259
- Parity bit: none.

WEBGUI

Login

default IP*: **192.168.5.163**
default username: **admin**
default password: **admin**

The login screen:

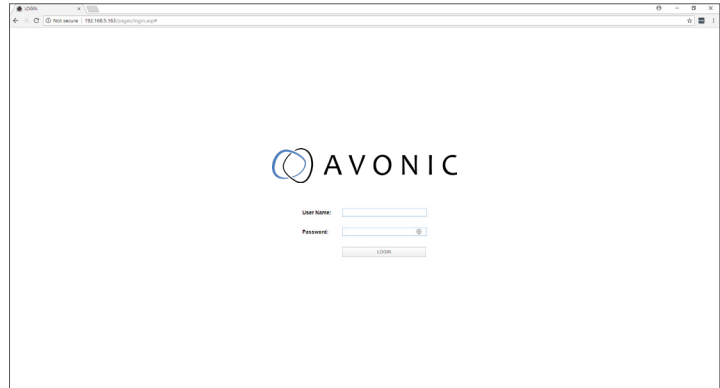

*Note:

If DHCP is enabled and there is no DHCP server available, the camera will self appoint an IPv4 link-local address between 169.254.0.0 and 169.254.255.255. The IP address is shown on screen at start-up.

Local

A preview of the camera ip-video output. When an image is not visible, make sure to have flash enabled for this webpage.

On the right is PTZ control, speed by zoom slider, focus and zoom functionality.

Click on the camera icon below the screen to switch preview between main stream and sub stream. Note that preview only works when the main- or sub-stream is set to H264 (see page 22).

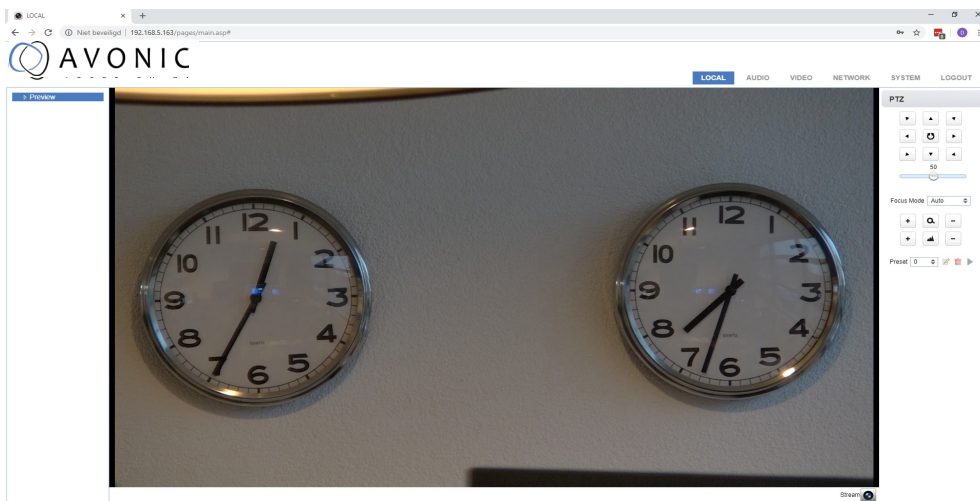

Audio

Enable or disable embedding of the audio input on the back of the camera.

Select encoding type mp3, AAC or G.711A

Select sample rate: 16000, 32000, 44100, 48000

Sample bits: always 16

Bitrate Kbps : 32, 48, 64, 96, 128

Channel: Mono or Stereo

Input volume: 1 ~ 10

Audio Delay (ms) 0 ~ 200



LOCAL **AUDIO** VIDEO NETWORK SYSTEM LOGOUT

> AUDIO

Audio

Enable

Encode Type

Sample Rate

Sample Bits

Bit Rate

Channel

Input Volume

Audio Delay(ms)

SAVE

Video

In this section you will find the various settings concerning the video output, including the main settings as found in the normal OSD menu of the camera..

Video Encoder

Video Encoder options:

	Main Stream	Sub Stream
Compressed Format :	MJPEG/ H.264/ H265	MJPEG/ H.264/ H265
Profile:	BP/ MP/ HP	BP/ MP/ HP
Image Size:	1920*1080/ 1280*720	1920*1080/ 1280*720/ 320*180/ 320*240/ 640*360
Rate Control:	CBR (constant bit rate)/ VBR (variable bit rate) depending on format	
Image quality:	fixed at 'best'	fixed at 'good'
Bit Rate (Kb/S):	64-40960	64-40960
Frame Rate (F/S):	5-60 frames per second	5-30 frames per second
I Frame Interval:	1-300	1-150
I Frame min. QP:	10-51	10-51
Stream name:	live/av0	live/av1
RTP Package*	Small Package (standard MTU size, 1500 bytes) Big Package** (approx. 60kb MTU size)	

Click on 'Save' to apply settings, a small dialogue screen appears in the bottom right of the window telling the settings are saved successfully.

* NOTE: a reboot is required after changing this setting.

**NOTE: when 'Big Package' is selected, the Local tab with flashplayer preview will stop functioning. Make sure the application you want to use is able to handle the 'Big Package' option.

Streaming Video

Stream options:

	Main Stream	Sub Stream
Enable:	mark checkbox to enable/ disable	mark checkbox to enable/ disable
Protocol type:	RTMP, SRT	RTMP, SRT
Host Address:	192.168.5.11	192.168.5.11
Host port:	1935	1935
Stream name:	live/av0	live/av1
User Name:	empty is default setting	empty is default setting
Password:	empty is default setting	empty is default setting
SRT Password for stream encr.:	empty is default setting	empty is default setting
Crypto key lenght in bytes:	0, 16, 24, 32	0, 16, 24, 32

Click on 'Save' to apply settings, a small dialogue screen appears in the bottom right of the window telling the settings are saved successfully

Multicast Streaming

Stream options:

	Main Stream	Sub Stream
Enable:	mark checkbox to enable/ disable	mark checkbox to enable/ disable
Protocol type:	RTP/ TS Multicast/ TS Unicast	RTP/ TS Multicast/ TS Unicast
Address (multicast):	224.0.0.0~ 239.255.255.255	224.0.0.0~ 239.255.255.255
Address (unicast):	Specify the ip address to which you want the Unicast stream pushed	
Port:	4000 (default)	4002 (default)
Acces Method:	rtp://224.1.2.3:4000	rtp://224.1.2.3:4002

Click on 'Save' to apply settings, a small dialogue screen appears in the bottom right of the window telling the settings are saved successfully.

Camera Settings

In this area all OSD settings can be changed like when using the remote control:

Focus, Exposure, Color, Image, Noise Reduction, Style. If a value is changed with the remote control, use the [refresh] button to update the webgui.

Note that only a picture will be shown with the main video stream set to H264.

- ▶ Video Encoder
- ▶ Streaming Video
- ▶ Multicast streaming
- ▶ **Camera settings**
- ▶ OSD
- ▶ Output format

Camera settings



Focus	Exposure	Color	Image	NR	Style	REFRESH
WB Mode	Auto					
RG Tuning					0	
BG Tuning					0	
Saturation	100%					
Hue					7	
AWB Sensitivity	High					

*Click the "Refresh" button to refresh parameter.
*Effective after changed parameters

CCM Customizable Color Matrix

If the additional license for SRT and the Customizable Color Matrix (CCM) has been purchased, the Camera Settings menu will have an extra tab in the camera settings; CCM. The CCM is intended to finetune the color settings of the camera to seamlessly integrate with an existing camerasystem.



- ▶ Video Encoder
- ▶ Streaming Video
- ▶ Multicast Streaming
- ▶ **Camera Settings**
- ▶ OSD
- ▶ Output Format
- ▶ SRT

Camera settings



	Focus	Exposure	Color	Image	NR	Style	CCM	REFRESH
Enable CCM <input checked="" type="checkbox"/>								
			R	G	B		CCM	
R			406	32921	15		268	
G			32824	367	32823		256	
B			5	32988	470		255	

*Click the "Refresh" button to refresh parameter.

*Effective after changed parameters

OSD

Note that only the output of the camera will be shown with the main stream set to H264.

In this area it is possible to put a camera name and time as overlay on the ip-stream (Overlay is exclusively available on the ip-stream, not on the other outputs).

Show time and show title can be enabled or disabled by marking or unmarking the checkbox next to the respective setting (the time and name settings can be found under the tab System chapters Attributes and Time).

Below is a dropdown menu for the desired font color as well as directional arrows to move the title and time to the preferred position on the screen.

OSD Font Size (related to Camera name and Time)

Scale size automatically to resolution for both main- and substream, check or uncheck box, if checked the camera name and time overlay will always scale with the image, keeping the proportions intact.

Save to apply settings, a small dialogue screen appears in the bottom right of the window telling the settings are saved successfully

▶ Video Encoder
▶ Streaming Video
▶ Multicast streaming
▶ Camera settings
▶ **OSD**
▶ Output format

OSD

CAMERA-1
01/01/1970 00:16:03

Show Time OSD Offset Title Time

Show Title

Time Font Color

Title Font Color

SAVE

OSD Font Size

According to the resolution

Scale size automatically

Master Stream OSD Font Size

Slave Stream OSD Font Size

SAVE

Output Format

This setting is related to the output resolution and framerate on the HDMI and SDI connectors, to set the resolution of the main- and sub-ipstreams use the webgui. The resolution of the USB output is determined by the computer connected to it.

Save to apply settings, a small dialogue screen appears in the bottom right of the window telling the settings are saved successfully

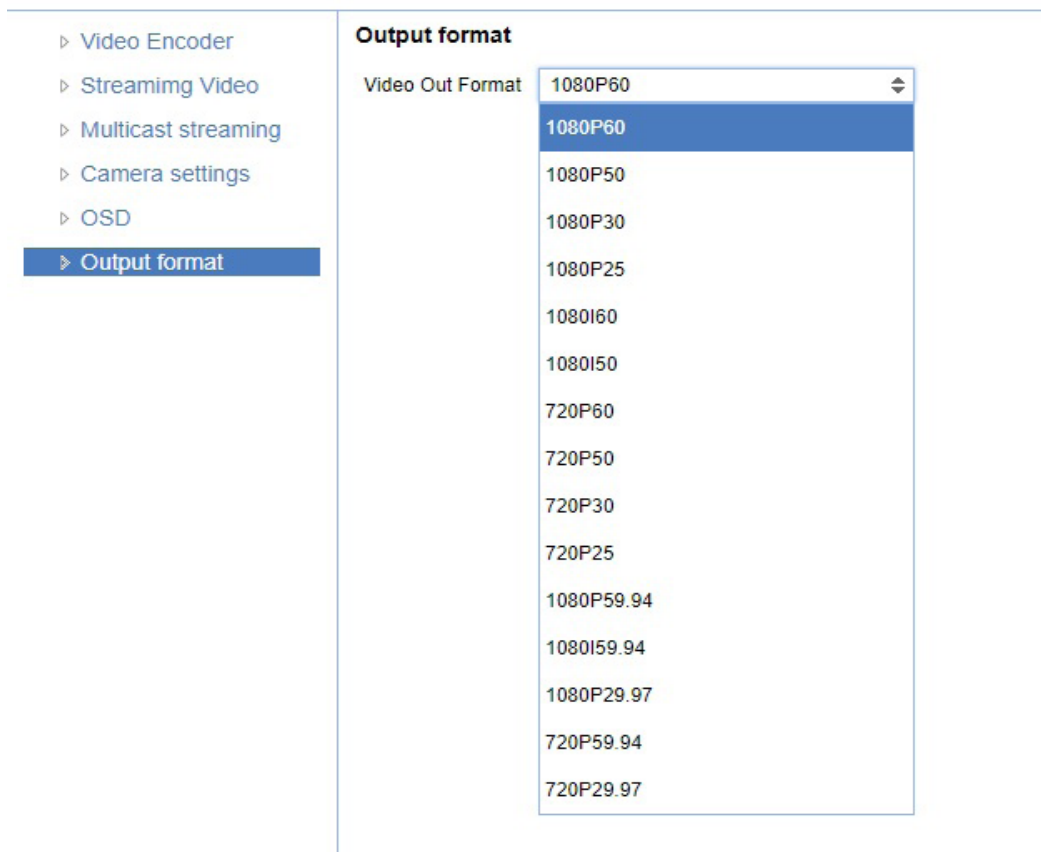

The screenshot displays the 'Output format' configuration page. On the left, a sidebar menu lists various settings: Video Encoder, Streaming Video, Multicast streaming, Camera settings, OSD, and Output format (which is highlighted in blue). The main content area is titled 'Output format' and features a dropdown menu labeled 'Video Out Format'. The dropdown is currently open, showing a list of video resolution and frame rate options. The selected option, '1080P60', is highlighted in blue. Other options include 1080P50, 1080P30, 1080P25, 1080I60, 1080I50, 720P60, 720P50, 720P30, 720P25, 1080P59.94, 1080I59.94, 1080P29.97, 720P59.94, and 720P29.97.

Video Out Format
1080P60
1080P50
1080P30
1080P25
1080I60
1080I50
720P60
720P50
720P30
720P25
1080P59.94
1080I59.94
1080P29.97
720P59.94
720P29.97

SRT Settings

These settings are related to the SRT streaming protocol; the port, passkey and encryption bit can be defined on this page.



- ▶ Video Encoder
- ▶ Streaming Video
- ▶ Multicast Streaming
- ▶ Camera Settings
- ▶ OSD
- ▶ Output Format
- ▶ SRT**

SRT

Port SRT

Password for stream encryption 

Password for stream encryption 

Network

Port Settings

On this page specific ports can be defined for the different streaming outputs and protocols the camera supports. Make sure these settings don't interfere with other uses and services on the same network. Save to apply settings, a small dialogue screen appears in the bottom right of the window telling the settings are saved successfully.

- ▶ Port Settings**
- ▶ Ethernet
- ▶ DNS

Port Settings

Port Data

Port Web

Port Onvif

Port Soap

Port RTMP

Port Rtsp

Port Visca

Ethernet

Ethernet and DNS settings

In this section the ip-settings for the ethernet adapter can be made; DHCP, IP address, Subnet Mask, Default Gateway and on the next tab, the Preferred and Alternative DNS server can be specified.

The MAC Address can be found on the last visible line.

Save to apply settings, a small dialogue screen appears in the bottom right of the window telling the settings are saved successfully and that a reboot is needed for the changes to take effect.

Port Settings
Ethernet
DNS

Ethernet

DHCP

IP Address

Subnet Mask

Default Gateway

MAC Address

SAVE

Port Settings
Ethernet
DNS

DNS

Preferred DNS Server

Alternative DNS Server

SAVE

System

License

If you have purchased the license for the premium features of this camera, this is where you can enter the License key to unlock them. No need for a reboot, it is instantly activated. The license can be bought through your local sales channel or contact Avonic directly.

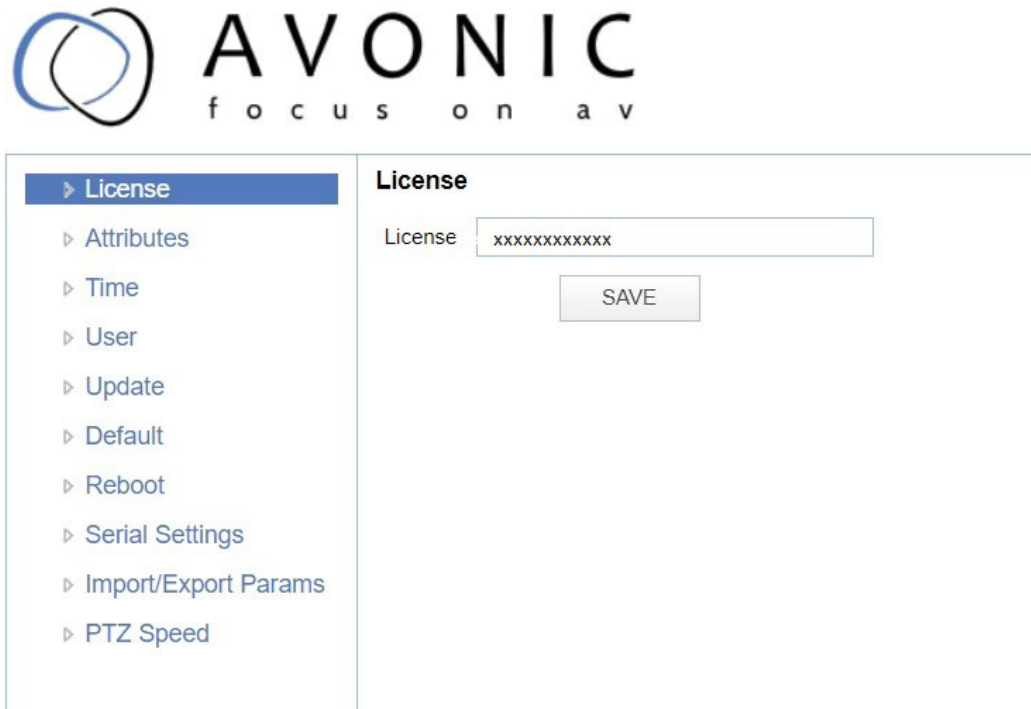

The screenshot shows the Avonic logo at the top, consisting of two overlapping circles and the text "AVONIC focus on av". Below the logo is a navigation menu with the following items: License (selected), Attributes, Time, User, Update, Default, Reboot, Serial Settings, Import/Export Params, and PTZ Speed. The main content area is titled "License" and contains a text input field labeled "License" with the placeholder text "xxxxxxxxxxxx". Below the input field is a "SAVE" button.

Attributes

Specify a specific device name to display in the OSD, which can be useful when using multiple cameras on the same LAN. Device-ID is always 1 (addressing is done via IP). The language cannot be changed.

Save to apply settings, a small dialogue screen appears in the bottom right of the window telling the settings are saved successfully.

WARNING: The ONVIF protocol doesn't accept spaces in the camera name.

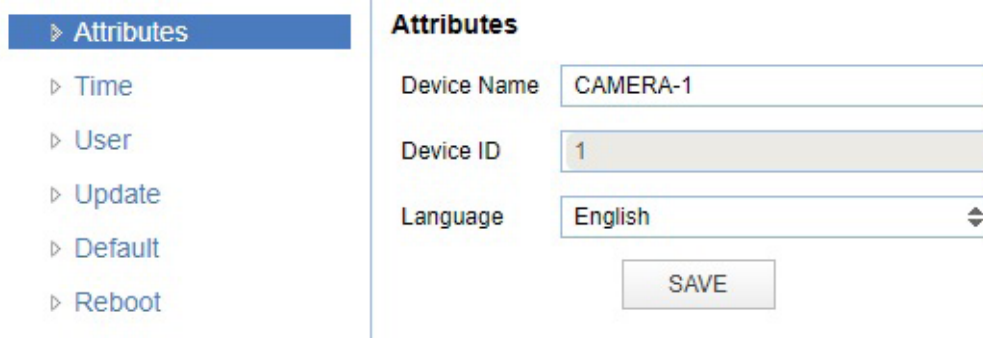

The screenshot shows the Avonic logo at the top. Below the logo is a navigation menu with the following items: Attributes (selected), Time, User, Update, Default, and Reboot. The main content area is titled "Attributes" and contains three fields: "Device Name" with the value "CAMERA-1", "Device ID" with the value "1", and "Language" with the value "English" (indicated by a dropdown arrow). Below the fields is a "SAVE" button.

Time

Manually set time and date or synchronize time and date via a computer or an external server on the LAN or WAN.

- ▷ Attributes
- ▷ Time
- ▷ User
- ▷ Update
- ▷ Default
- ▷ Reboot

Time

Date Format	MM-DD-YYYY
Date Sprtr	/
Zone	(GMT+01:00)Berlin, Stockholm, Rorr
Hour Type	24 Hours
NTP Enable	<input type="checkbox"/>
Update Interval	1 day
Host Url	time.nist.gov
Host Port	123

SAVE

Time Settings

Time Settings	Synchronize with computer time
Computer Time	2019-02-21 14:10:47

SYNC.

User

Define different users with levels of permission and different username passwords combinations. There are 2 levels of users: administrators with access to all features and user-1 and user-2 with access to the preview and PTZ-controls.

- ▷ Attributes
- ▷ Time
- ▷ User
- ▷ Update
- ▷ Default
- ▷ Reboot

User

Authority	admin
User Name	admin
Password
Confirm Password	

SAVE

Update

By default this screen shows a readout of the current firmware versions. Update file provides a firmware upgrade functionality via this screen. When the camera is done uploading and processing the update it will reboot. Make sure to refresh your browser and log in again after the reboot.

- ▷ Attributes
- ▷ Time
- ▷ User
- ▷ Update
- ▷ Default
- ▷ Reboot

Update

MCU Version	V2.4.1 2019-1-24
Camera Version	V2.4.1 2019-1-25
AF Version	V4.0.2 2018-12-4
Update File	Bestand kiezen Geen bestand gekozen

UPGRADE

Default

Click on the button to perform a factory default. The camera will be ready for use again after the boot cycle.



Reboot

Click on the button to activate a reboot, the camera will be ready for use after it has restarted. Log in again after the reboot.

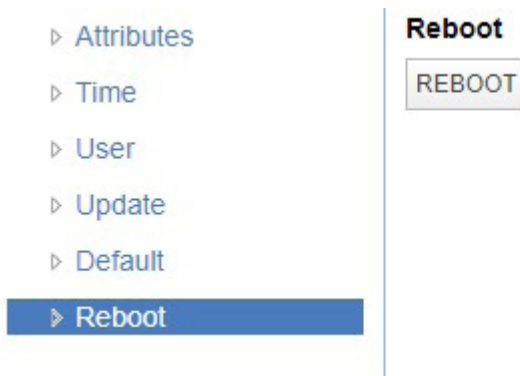

Serial Settings

Choose the preferred protocol to use and the accompanying address to go with it. Or leave the system on 'auto' and have the camera detect which protocol is being used (addressing is still needed, even on auto).

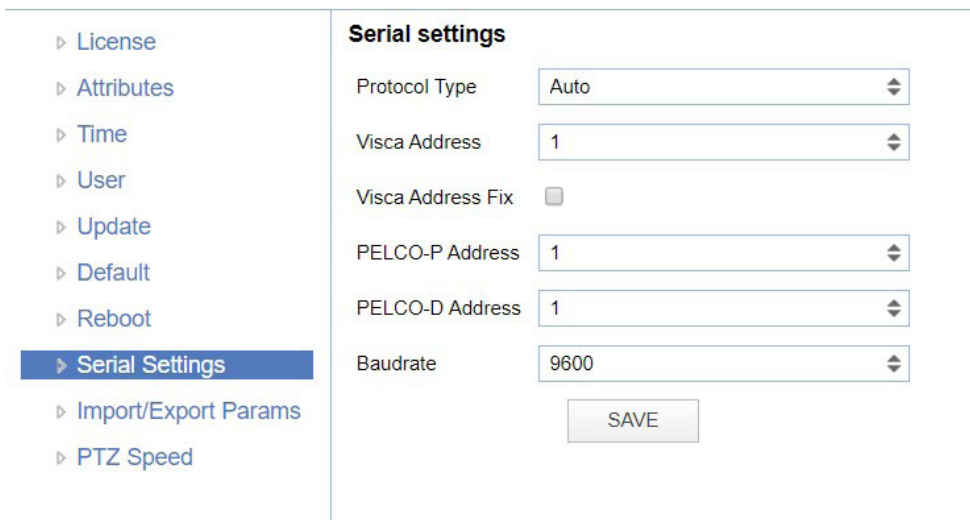

Import/Export Parameters

The CM7x cameras have the ability to import or export a configuration.

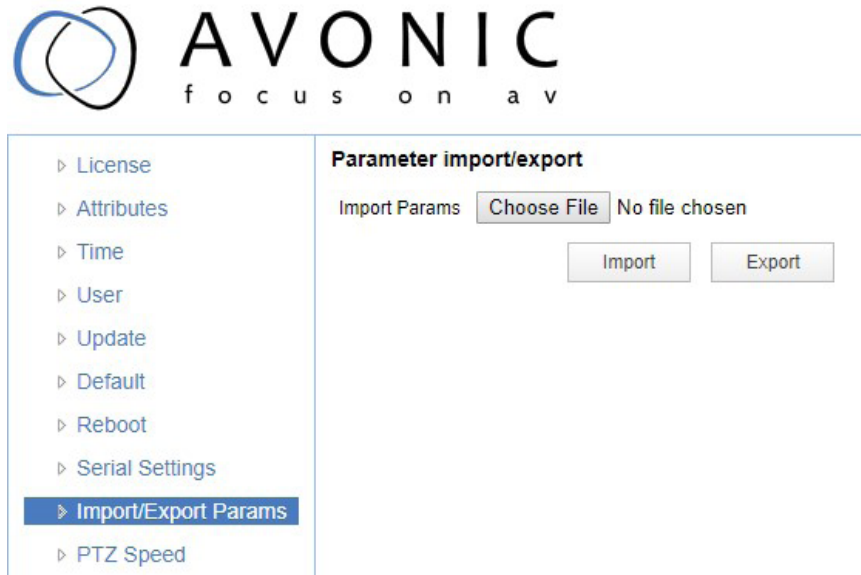

PTZ Speed

It is possible to increase the maximum pan and tilt speed, this can be useful in a conference system where quick action is necessary. The camera will produce slightly more noise when this setting is set to 'high'.

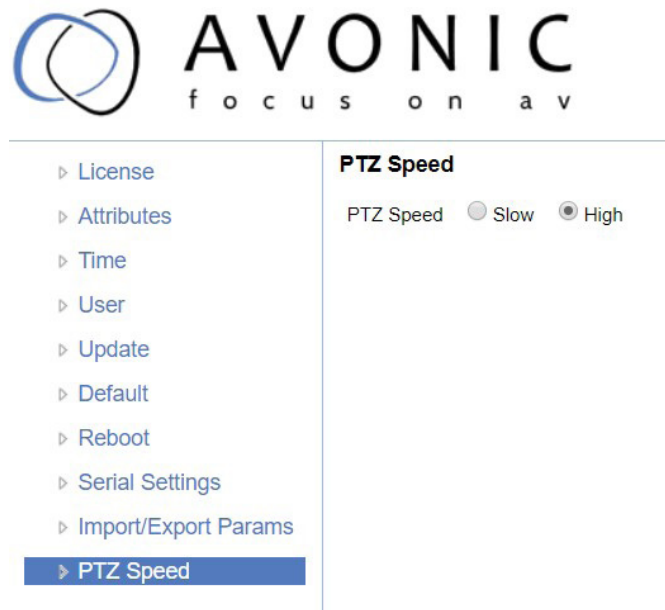

MJPEG Snapshot

The Avonic CM7x-IP cameras are equipped with a MJPEG snapshot feature for example to implement into third party software.

To access the MJPEG snapshot feature use the following format:

`http://IP/img/capjpg/snapshot.jpg`

Every time the page is refreshed the picture will be updated.

MAINTENANCE

Camera Maintenance

- If the camera will not be used for a long time, please turn off the power switch, disconnect AC power cord of AC adaptor to the outlet.
- Use soft cloth or tissue to clean the camera cover.
- Please use the soft dry cloth to clean the lens. If the camera is very dirty, clean it with diluted neutral detergent. Do not use any type of solvents, which may damage the surface.

Unauthorized Use

- Do not film extreme bright objects for a prolonged period of time, such as sunlight, light sources, etc.
- Do not operate in unstable lighting conditions, otherwise the produced image could be less than optimal.
- Do not operate close to powerful electromagnetic radiation, such as TV or radio transmitters, etc.

TROUBLESHOOTING

General Advice

- Turn the camera off and on again and check if the problem persists.
- Restore to Factory Default

Power Issues

- No self-test (applies only to PTZ cameras) and no power LED
 - Check the net power
 - Check the power supply
 - Check the physical power button on the back of the camera

Image

- No image
 - Check power of camera and monitor
 - Check video cable quality and length
 - Check if video specifications of monitor match the specs of the camera
- Abnormal image
 - Check video cable quality and length
 - Check cable connections
- Dithering or flickering image
 - Check camera fixation and nearby vibration sources
 - Check anti-flickering setting in OSD
 - Check Noise Reduction settings in OSD
- Color issues
 - Check options in OSD, like exposure, white balance, color temp, Red and Blue tuning

Control

- No self-test (PTZ cameras only) and no power LED
 - Check the net power
 - Check the power supply
- Remote Controller does not work
 - Check power of the controller
 - Check RS-232 or RS-485 cable quality, length, polarity and network architecture
 - Check serial communication settings on both camera and controller
 - Check VISCA / PELCO address settings on both camera and controller
 - Check IP network settings on both camera and controller

WebGUI

- Cannot enter WebGUI
 - Check network cable
 - Check if PC is in the same subnet as camera
 - Reset the factory default ip settings by pressing [*] [#] [Manual] and Reboot
- Firmware update failed
 - Check firmware file integrity, download it again.

VISCA command list

Replace the 'x' in all the '8x' addresses with the serial Visca address set in the camera to control it. When using VISCA over IP the 'x' in all the '8x' addresses is always '1', as the unique identifier is the IP address.

VISCA over IP commands

The Avonic IP camera is implemented with a TCP server. The TCP port number is 1259 by default and can be altered in the WebGUI. Once the connection between client and server is set up, the client will be able to send PTZ commands to the server. The server then parses and executes the PTZ command.

The Avonic IP Camera also has an implemented UDP server. The UDP port number is fixed on 1259. Once the connection between client and server is set up, the client will be able to send PTZ commands to the server. The server then parses and executes the PTZ command.

Pay attention to the fact that the camera does not send back any communication via UDP.

The VISCA over IP command list is based on the VISCA protocol. Not all VISCA commands are implemented.

The PTZ Command format is according to the definition of the VISCA protocol. The VISCA address of the camera is set to 1 by default and can be changed in the WebGUI. As all cameras are uniquely identified by their IP address, all VISCA serial addresses of the cameras that are controlled over IP do not necessarily have to be unique.

Default settings:

TCP port	1259
UDP port	1259 (same port as TCP; is correct)
VISCA address	1

1. Camera return commands

x = Camera Address

y = Socket Number

z = Camera Address + 8

All parameter values are in HEX

Return/complete Command			
Command	Function	Command Packet	Comments
ACK/Completion Messages	ACK	90 4y FF (y: Socket No.)	Return when the command is accepted.
	Completion	90 5y FF (y: Socket No.)	Return when the command has been executed.

Error command			
Command	Function	Command Packet	Comments
Error Messages	Syntax Error	90 60 02 FF	Returned when the command format is different or when a command with illegal command parameters is accepted.
	Command Buffer Full	90 60 03 FF	Indicates that two sockets are already being used (executing two commands) and the command could not be accepted when received.
	Command Canceled	90 6y 04 FF (y: Socket No.)	Returned when a command which is being executed in a socket specified by the cancel command is canceled. The completion message for the command is not returned.
	No Socket	90 6y 05 FF (y: Socket No.)	Returned when no command is executed in a socket specified by the cancel command, or when an invalid socket number is specified.
	Command Not Executable	90 6y 41 FF (y: Execution command Socket No. Inquiry command: 0)	Returned when a command cannot be executed due to current conditions. For example, when commands controlling the focus manually are received during auto focus.

2 Camera control commands

x = Camera Address

y = Socket Number

z = Camera Address + 8

All parameter values are in HEX

Camera control commands			
Command	Function	Command Packet	Comments
Address Set	Broadcast	88 30 01 FF	Address setting
CAM_Power	On	8x 01 04 00 02 FF	Power ON (only works over serial connection)
	Off	8x 01 04 07 00 FF	Power OFF
CAM_Zoom	Stop	8x 01 04 07 00 FF	
	Tele (Standard speed)	8x 01 04 07 02 FF	
	Wide (Standard speed)	8x 01 04 07 03 FF	
	Tele (Variable speed)	8x 01 04 07 2p FF	p = 0(low speed) - F(high speed)
	Wide (Variable speed)	8x 01 04 07 3p FF	
	Direct	8x 01 04 47 0p 0q 0r 0s FF	pqrs(0-F): Zoom Position
CAM_Focus	Stop	8x 01 04 08 00 FF	
	Far (Standard speed)	8x 01 04 08 02 FF	
	Near (Standard speed)	8x 01 04 08 03 FF	
	Far (Variable speed)	8x 01 04 08 2p FF	p = 0(low) - F(high)
	Near (Variable speed)	8x 01 04 08 3p FF	
	Direct Focus Position	8x 01 04 48 0p 0q 0r 0s FF	min p=0,q=0,r=0,s=0 max p=0,q=6,r=E,s=A
	Auto Focus	8x 01 04 38 02 FF	AF On
	Manual Focus	8x 01 04 38 03 FF	AF Off
	Auto/Manual	8x 01 04 38 10 FF	AF Toggle On/Off
CAM_WB	Auto	8x 01 04 35 00 FF	Normal Auto
	Indoor mode	8x 01 04 35 01 FF	Indoor mode
	Outdoor mode	8x 01 04 35 02 FF	Outdoor mode
	OnePush mode	8x 01 04 35 03 FF	One Push WB mode
	Manual	8x 01 04 35 05 FF	Manual Control mode
	OnePush trigger	8x 01 04 10 05 FF	One Push WB Trigger
CAM_RGain	Reset	8x 01 04 03 00 FF	Manual Control of R Gain
	Up	8x 01 04 03 02 FF	
	Down	8x 01 04 03 03 FF	
	Direct	8x 01 04 43 00 00 0p 0q FF	pq: R Gain

Camera control commands			
Command	Function	Command Packet	Comments
CAM_Bgain	Reset	8x 01 04 04 00 FF	Manual Control of B Gain
	Up	8x 01 04 04 02 FF	
	Down	8x 01 04 04 03 FF	
	Direct	8x 01 04 44 00 00 0p 0q FF	pq: B Gain
CAM_AE	Full Auto	8x 01 04 39 00 FF	Automatic Exposure mode
	Manual	8x 01 04 39 03 FF	Manual Control mode
	Shutter priority	8x 01 04 39 0A FF	Shutter Priority Automatic Exposure mode
	Iris priority	8x 01 04 39 0B FF	Iris Priority Automatic Exposure mode
	Bright	8x 01 04 39 0D FF	Bright Mode(Manual control)
CAM_Iris	Reset	8x 01 04 0B 00 FF	Iris Setting (CAM_AE is set to Iris Priority)
	Up	8x 01 04 0B 02 FF	
	Down	8x 01 04 0B 03 FF	
	Direct Iris Position	8x 01 04 4B 00 00 0p 0q FF	min p = 0 q = 0 max p = 0, q = C
CAM-Shutter	Direct	8x 01 04 4A 00 00 0p 0q FF	min p = 0 q = 0 max p = 1 q = 0
CAM_Gain	Reset	8x 01 04 0C 00 FF	Gain Setting
	Up	8x 01 04 0C 02 FF	
	Down	8x 01 04 0C 03 FF	
	Direct	8x 01 04 0C 00 00 0p 0q FF	pq: Gain Position
	Gain Limit	8x 01 04 2C 0p FF	p: Gain Position
CAM_Bright (only works with exposure mode Bright enabled)	Reset	8x 01 04 0D 00 FF	Bright Setting
	Up	8x 01 04 0D 02 FF	
	Down	8x 01 04 0D 03 FF	
	Direct	8x 01 04 0D 00 00 0p 0q FF	pq: Bright Position
CAM_ExpComp	On	8x 01 04 3E 02 FF	Exposure Compensation On/Off
	Off	8x 01 04 3E 03 FF	
	Reset	8x 01 04 0E 00 FF	Exposure Compensation Amount Setting
	Up	8x 01 04 0E 02 FF	
	Down	8x 01 04 0E 03 FF	
	Direct	8x 01 04 4E 00 00 0p 0q FF	pq: ExpComp Position
CAM_BackLight	On	8x 01 04 33 02 FF	Back Light Compensation On/Off
	Off	8x 01 04 33 03 FF	

Camera control commands			
Command	Function	Command Packet	Comments
CAM_NR(2D)Mode	Auto	8x 01 04 50 02 FF	ND2D Auto/Manual
	Manual	8x 01 04 50 03 FF	
CAM_NR(2D)Level	-	8x 01 04 53 0p FF	p: NR Setting (0: Off, level 1 to 5)
CAM_NR(3D)Level	-	8x 01 04 54 0p FF	p: NR Setting (0: Off, level 1 to 8)
CAM_Flicker	-	8x 01 04 23 0p FF	p: Flicker Settings (0: Off, 1: 50Hz, 2: 60Hz)
CAM_DHotPixel	-	8x 01 04 56 0p FF	p: Dynamic Hot Pixel Setting (0: Off, level 1 to 6)
CAM_Aperture(sharpness)	Reset	8x 01 04 02 00 FF	Aperture Control
	Up	8x 01 04 02 02 FF	
	Down	8x 01 04 02 03 FF	
	Direct	8x 01 04 42 00 00 0p 0q FF	pq: Aperture Gain
CAM_PictureEffect	Off	8x 01 04 63 00 FF	Picture Effect Setting
	B&W	8x 01 04 63 04 FF	
CAM_Memory	Reset	8x 01 04 3F 00 pp FF	pp: Memory Number(=0 to 127)
	Set	8x 01 04 3F 01 pp FF	
	Recall	8x 01 04 3F 02 pp FF	
CAM_LR_Reverse	On	8x 01 04 61 02 FF	Image Flip Horizontal On/Off
	Off	8x 01 04 61 03 FF	
CAM_PictureFlip	On	8x 01 04 66 02 FF	Image Flip Vertical On/Off
	Off	8x 01 04 66 03 FF	
CAM_ColorGain	Diret	8x 01 04 49 00 00 00 0p FF	p: Color Gain setting 0h (60%) to Eh (200%)
SYS_Menu	Off	8x 01 06 06 03 FF	Turns on/off the menu screen
	On	8x 01 06 06 02 FF	

Camera control commands			
Command	Function	Command Packet	Comments
Pan_tiltDrive	Up	8x 01 06 01 VV WW 03 01 FF	VV: Pan speed 0x01 (low speed) to 0x18 (high speed) WW: Tilt speed 0x01 (low speed) to 0x14 (high speed) YYYY: Pan Position ZZZZ: Tilt Position
	Down	8x 01 06 01 VV WW 03 02 FF	
	Left	8x 01 06 01 VV WW 01 03 FF	
	Right	8x 01 06 01 VV WW 02 03 FF	
	Upleft	8x 01 06 01 VV WW 01 01 FF	
	Upright	8x 01 06 01 VV WW 02 01 FF	
	DownLeft	8x 01 06 01 VV WW 01 02 FF	
	DownRight	8x 01 06 01 VV WW 02 02 FF	
	Stop	8x 01 06 01 VV WW 03 03 FF	
	AbsolutePosition	8x 01 06 02 VV WW 0Y 0Y 0Y 0Y 0Z 0Z 0Z 0Z FF	
	RelativePosition	8x 01 06 03 VV WW 0Y 0Y 0Y 0Y 0Z 0Z 0Z 0Z FF	
	Home	8x 01 06 04 FF	
Reset	8x 01 06 05 FF		
Pan_tiltLimitSet	LimitSet	8x 01 06 07 00 0W 0Y 0Y 0Y 0Y 0Z 0Z 0Z 0Z FF	W: 1 UpRight 0: Down-Left YYYY: Pan Limit Position ZZZZ: Tilt Position
	LimitClear	8x 01 06 07 01 0W 07 0F 0F 0F 07 0F 0F 0F FF	
CAM_AFSensitivity	High	8x 01 04 58 01 FF	AF Sensitivity High/ Normal/Low
	Normal	8x 01 04 58 02 FF	
	Low	8x 01 04 58 03 FF	
CAM_SettingReset	Reset	8x 01 04 A0 10 FF	Reset Factory Setting
CAM_Brightness	Direct	8x 01 04 A1 00 00 0p 0q FF	pq: Brightness Position
CAM_Contrast	Direct	8x 01 04 A2 00 00 0p 0q FF	pq: Contrast Position
CAM_Flip	Off	8x 01 04 A4 00 FF	Single Command For Video Flip
	Flip-H	8x 01 04 A4 01 FF	
	Flip-V	8x 01 04 A4 02 FF	
	Flip-HV	8x 01 04 A4 03 FF	
CAM_SettingSave	Save	8x 01 04 A5 10 FF	Save Current Setting
CAM_Iridix	Direct	8x 01 04 A7 00 00 0p 0q FF	pq: Iridix Position

Camera control commands			
Command	Function	Command Packet	Comments
CAM_AWBSensitivity	High	8x 01 04 A9 00 FF	High
	Normal	8x 01 04 A9 01 FF	Normal
	Low	8x 01 04 A9 02 FF	Low
CAM_AFZone	Top	8x 01 04 AA 00 FF	AF Zone weight select
	Center	8x 01 04 AA 01 FF	
	Bottom	8x 01 04 AA 02 FF	
CAM_ColorHue	Direct	8x 01 04 4F 00 00 00 0p FF	p: Color Hue setting 0h (-14 degrees) to Eh (+14 degrees)

3 Inquiry commands

x = Camera Address

y = Socket Number

z = Camera Address + 8

All parameter values are in HEX

Inquiry Command			
Command	Function	Command Packet	Comments
CAM_ZoomPosInq	8x 09 04 47 FF	90 50 0p 0q 0r 0s FF	pqrs: Zoom Position
CAM_FocusAF-ModelInq	8x 09 04 38 FF	90 50 02 FF	Auto Focus
		90 50 03 FF	Manual Focus
CAM_FocusPosInq	8x 09 04 48 FF	90 50 0p 0q 0r 0s FF	pqrs: Focus Position
CAM_WBModelInq	8x 09 04 35 FF	90 50 00 FF	Auto
		90 50 01 FF	Indoor mode
		90 50 02 FF	Outdoor mode
		90 50 03 FF	OnePush mode
		90 50 05 FF	Manual
CAM_RGainInq	8x 09 04 43 FF	90 50 00 00 0p 0q FF	pq: R Gain
CAM_BGainInq	8x 09 04 44 FF	90 50 00 00 0p 0q FF	pq: B Gain
CAM_AEModelInq	8x 09 04 39 FF	90 50 00 FF	Full Auto
		90 50 03 FF	Manual
		90 50 0A FF	Shutter priority
		90 50 0B FF	Iris priority
		90 50 0D FF	Bright
CAM_ShutterPosInq	8x 09 04 4A FF	90 50 00 00 0p 0q FF	pq: Shutter Position
CAM_IrisPosInq	8x 09 04 4B FF	90 50 00 00 0p 0q FF	pq: Iris Position
CAM_BrightPosInq	8x 09 04 4D FF	90 50 00 00 0p 0q FF	pq: Bright Position

Inquiry Command			
Command	Function	Command Packet	Comments
CAM_ExpComp-Modelnq	8x 09 04 3E FF	90 50 02 FF	On
		90 50 03 FF	Off
CAM_ExpCompPoslnq	8x 09 04 4E FF	90 50 00 00 0p 0q FF	pq: ExpComp Position
CAM_Backlight-Modelnq	8x 09 04 33 FF	90 50 02 FF	On
		90 50 03 FF	Off
CAM_Noise2DLevel	8x 09 04 53 FF	90 50 0p FF	Noise Reduction (2D) p: 0 to 5
CAM_Noise3DLevel	8x 09 04 54 FF	90 50 0p FF	Noise Reduction (3D) p: 0 to 8
CAM_Flicker-Modelnq	8x 09 04 55 FF	90 50 0p FF	p: Flicker Settings(0: OFF, 1: 50Hz, 2: 60Hz)
CAM_Aperture-Modelnq(Sharpness)	8x 09 04 05 FF	90 50 02 FF	Auto Sharpness
		90 50 03 FF	Manual Sharpness
CAM_Aperturelnq(Sharpness)	8x 09 04 42 FF	90 50 00 00 0p 0q FF	pq: Aperture Gain
CAM_PictureEffect-Modelnq	8x 09 04 63 FF	90 50 02 FF	Off / Color
		90 50 04 FF	B&W
CAM_Memorylnq	8x 09 04 3F FF	90 50 0p FF	p: Memory number last operated.
SYS_MenuModelnq	8x 09 06 06 FF	90 50 02 FF	On
		90 50 03 FF	Off
CAM_LR_Reverselnq	8x 09 04 61 FF	90 50 02 FF	On
		90 50 03 FF	Off
CAM_PictureFliplnq	8x 09 04 66 FF	90 50 02 FF	On
		90 50 03 FF	Off
CAM_ColorGainlnq	8x 09 04 49 FF	90 50 00 00 00 0p FF	p: Color Gain setting 0h (60%) to Eh (200%)

Inquiry Command			
Command	Function	Command Packet	Comments
VideoSystemInq	8x 09 06 23 FF	90 50 00 FF	1920x1080p60
		90 50 01 FF	1920x1080p50
		90 50 02 FF	1920x1080i60
		90 50 03 FF	1920x1080i50
		90 50 04 FF	1280x720p60
		90 50 05 FF	1280x720p50
		90 50 06 FF	1920x1080p30
		90 50 07 FF	1920x1080p25
		90 50 08 FF	1280x720p30
		90 50 09 FF	1280x720p25
		90 50 0A FF	1920x1080p59.94
		90 50 0B FF	1920x1080i59.94
		90 50 0C FF	1280x720p59.94
		90 50 0D FF	1920x1080p29.97
90 50 0E FF	1280x720p29.97		
Pan-tiltMaxSpeedInq	8x 09 06 11 FF	90 50 ww zz FF	ww: Pan Max Speed zz: Tilt Max Speed
Pan-tiltPosInq	8x 09 06 12 FF	90 50 0w 0w 0w 0w 0z 0z 0z 0z FF	www: Pan Position zzz: Tilt Position
CAM_GainLimitInq	8x 09 04 2C FF	90 50 0q FF	p: Gain Limit
CAM_DHotPixelInq	8x 09 04 56 FF	90 50 0q FF	p: Dynamic Hot Pixel Setting (0: Off, level 1 to 6)
CAM_AFSensitivityInq	8x 09 04 58 FF	90 50 01 FF	High
		90 50 02 FF	Normal
		90 50 03 FF	Low
CAM_BrightnessInq	8x 09 04 A1 FF	90 50 00 00 0p 0q FF	pq: Brightness Position
CAM_ContrastInq	8x 09 04 A2 FF	90 50 00 00 0p 0q FF	pq: Contrast Position
CAM_FlipInq	8x 09 04 A4 FF	90 50 00 FF	Off
		90 50 01 FF	Flip-H
		90 50 02 FF	Flip-V
		90 50 03 FF	Flip-HV
CAM_IridixInq	8x 09 04 A7 FF	90 50 00 00 0p 0q FF	pq: Iridix Position
CAM_AFZone	8x 09 04 AA FF	90 50 00 FF	Top
		90 50 01 FF	Center
		90 50 02 FF	Bottom
CAM_ColorHueInq	8x 09 04 4F FF	90 50 00 00 00 0p FF	p: Color Hue setting 0h (- 14 degrees) to Eh (+14 degrees)
CAM_AWBSensitivityInq	81 09 04 A9 FF	90 50 00 FF	High
		90 50 01 FF	Normal
		90 50 02 FF	Low

AV-CM7x specific commands			
Command	Function	Command Packet	Comments
Pan-tilt_MaxSpeed	High Speed Pan/Tilt ON	8x 0A 01 31 03 FF	High Speed PT ON
	High Speed Pan/Tilt OFF	8x 0A 01 31 02 FF	High Speed PT OFF
ARM/MCU_Version Inq	Inquiry ARM/MCU Version	8x 09 0A 01 03 FF	
CAM/UVC_Version Inq	Inquiry Cam/UVC version	8x 09 00 02 FF	
CAM_TallyLight	Red	8x 01 7E 01 0A 00 02 03 FF	Tally Light Red ON
	Green	8x 01 7E 01 0A 00 03 02 FF	Tally Light Green ON
	Off	8x 01 7E 01 0A 00 03 03 FF	Tally Light OFF

APPENDIX B DIMENSIONS

