

15000+/-250

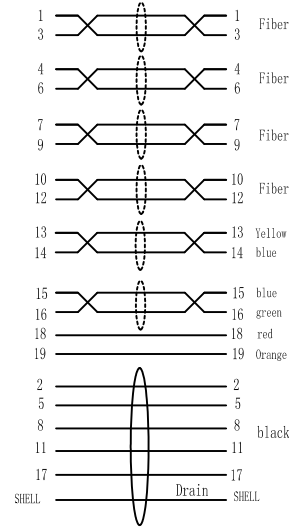

NOTES:
8K@60Hz
Support 48Gbps
Support 100M

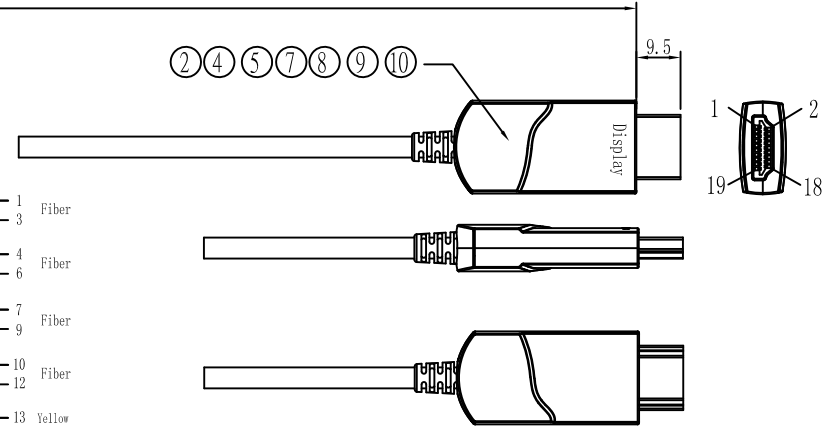
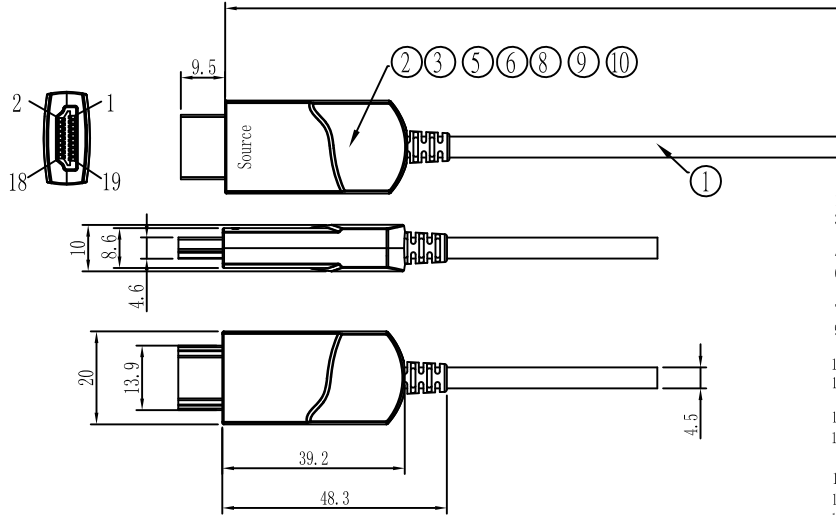
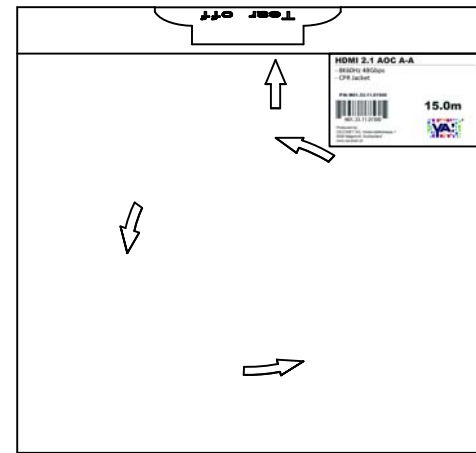
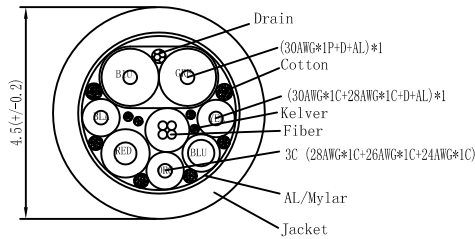

ITEM	SPECIFICATIONS	Q'TY	UNIT
10	Screw	4	PCS
9	Clip	2	PCS
8	SR black	2	PCS
7	HDMI A male shell(Bottom) Black(Display)	1	PCS
6	HDMI A male shell(Bottom) Black(Source)	1	PCS
5	HDMI A male shell(Upper) Black	2	PCS
4	HDMI A PCBA (Display)	1	PCS
3	HDMI A PCBA (Source)	1	PCS
2	HDMI A mail Plug Gold-Plated	2	PCS
1	(30AWG*1P+D+AL)*1+(30AWG*1C+28AWG*1C+D+AL)+28AWG*1C+26AWG*1C+24AWG*1C+Fiber+F+AL Black CPR OD(4.5±0.2)mm	TABLE A	mm

TOLERANCE	SCALE	SHEEL	DRAWN BY	DATE
.X	±0.25	1 OF 1	Peter	13/05/2020
.XX	±0.10	A	CHECKED BY	DATE
ANGLES	±0.5°	MATERIAL	THIRD ANGLE PROJECTION	

HDMI 2.1 AOC A-A	
8K60Hz 48Gbps,15m	
PART NO.	DWG NO.
M01.33.11.01500	-

