

HDMI[®]
HIGH-DEFINITION MULTIMEDIA INTERFACE

HDCP 2.2



EL-XSTREAM-PIP

4x2 HDMI Switch with Integrated Multi-View
& Video Capture

OPERATION MANUAL

HDMI®
HIGH-DEFINITION MULTIMEDIA INTERFACE

The terms HDMI, HDMI High-Definition Multimedia Interface, and the HDMI Logo are trademarks or registered trademarks of HDMI licensing Administrator, Inc.

DISCLAIMERS

The information in this manual has been carefully checked and is believed to be accurate. CYP (UK) Ltd assumes no responsibility for any infringements of patents or other rights of third parties which may result from its use.

CYP (UK) Ltd assumes no responsibility for any inaccuracies that may be contained in this document. CYP (UK) Ltd also makes no commitment to update or to keep current the information contained in this document.

CYP (UK) Ltd reserves the right to make improvements to this document and/or product at any time and without notice.

COPYRIGHT NOTICE

No part of this document may be reproduced, transmitted, transcribed, stored in a retrieval system, or any of its part translated into any language or computer file, in any form or by any means—electronic, mechanical, magnetic, optical, chemical, manual, or otherwise—without express written permission and consent from CYP (UK) Ltd.

© Copyright 2020 by CYP (UK) Ltd.

All Rights Reserved.

Version 1.1

TRADEMARK ACKNOWLEDGMENTS

All products or service names mentioned in this document may be trademarks of the companies with which they are associated.



SAFETY PRECAUTIONS

Please read all instructions before attempting to unpack, install or operate this equipment and before connecting the power supply.

Please keep the following in mind as you unpack and install this equipment:

- Always follow basic safety precautions to reduce the risk of fire, electrical shock and injury to persons.
- To prevent fire or shock hazard, do not expose the unit to rain, moisture or install this product near water.
- Never spill liquid of any kind on or into this product.
- Never push an object of any kind into this product through any openings or empty slots in the unit, as you may damage parts inside the unit.
- Do not attach the power supply cabling to building surfaces.
- Use only the supplied power supply unit (PSU). Do not use the PSU if it is damaged.
- Do not allow anything to rest on the power cabling or allow any weight to be placed upon it or any person walk on it.
- To protect the unit from overheating, do not block any vents or openings in the unit housing that provide ventilation and allow for sufficient space for air to circulate around the unit.

REVISION HISTORY

REV.	DATE	SUMMARY OF CHANGE
v1.00	2020/06/23	Preliminary release

CONTENTS

1. Introduction	1
2. Applications	2
3. Package Contents	2
4. System Requirements	2
5. Features	3
5.1 Multiviewer Component Features	3
5.2 Video Capture Component Features	4
6. Operation Controls and Functions	5
6.1 Front Panel	5
6.2 Rear Panel	7
6.3 RS-232 Pinout and Defaults (Multiviewer)	8
6.4 OSD Menu (Multiviewer)	9
6.5 WebGUI Control (Multiviewer)	26
6.5.1 Upper Tab Windows	28
6.5.2 Window Layout Tab	29
6.5.3 Picture Tab	31
6.5.4 Audio Tab	32
6.5.5 Input EDID Tab	33
6.5.6 HDCP Mode & Status Tab	34
6.5.7 OSD Settings Tab	35
6.5.8 Logo Settings Tab	36
6.5.9 Ethernet Tab	37



6.5.10 Setup Tab	38
6.5.11 Information Tab	39
6.6 Video Capture Control & Configuration	40
6.6.1 USB Video Capture Configuration	40
6.6.2 Video Capture	42
6.7 Telnet Control (Multiviewer)	43
6.8 Serial and Telnet Commands (Multiviewer)	43
7. Connection Diagram	65
8. Specifications	66
8.1 Technical Specifications	66
8.2 Video Specifications.....	67
8.3 Audio Specifications.....	69
8.3.1 Digital Audio	69
8.3.2 Analogue Audio	70
8.4 Cable Specifications	70
9. Acronyms.....	71

1. INTRODUCTION

Video conferencing is an important and convenient way to communicate with people around the globe. If you want to express your thoughts clearly by sharing a variety of rich images, an integrated machine with multi-windowing and video capture functions is a splendid idea. This Multiviewer with Streaming Solution for Video Conferencing is just the thing to meet your requirements. Besides being a high performance HDMI matrix switch with integrated scaling and multi-windowing technology, a video capture component is also included!

Any of 4 different HDMI sources may be displayed individually, full screen, with seamless switching in Matrix mode, or they can be displayed using a variety of multi-window modes including standard views like PiP and PoP as well as fully customizable quad-window modes. By using an HDMI cable to connect between the multiviewer component's output and the video capture component's input above it, the unit is transformed into a flexible video streaming, distribution, and recording powerhouse. In this configuration, all HDMI ports support resolutions up to 18Gbps 4K UHD⁺ (via the bypass path) while simultaneously streaming the audio and video signal at 1080p to a USB connected PC for capture or re-broadcast. USB capture is accomplished using the UAC (USB Audio Class) and UVC (USB Video Class) standards, allowing the video capture component to support most common video capture, chat, or streaming software, including the Free OBS (Open Broadcaster Software) streaming software which is available for Windows PC, macOS and Linux.

The video capture component of the unit is powered directly by the USB 3.0 port while the multiviewer component is powered via a DC 24V power source and both components can be operated independently if desired. Control of the multiviewer component is via front panel controls, WebGUI, RS-232, and Telnet while control of the video capture component is handled by software on the computer connected via USB 3.0.

2. APPLICATIONS

- /// Medical procedure multiview recording and distribution
- /// Live video streaming and recording
- /// Distance learning
- /// Security camera recording
- /// Gameplay video webcasting and archival
- /// Entertainment room & home theater matrixing
- /// Lecture hall presentations
- /// Public commercial displays

3. PACKAGE CONTENTS

- /// 1× Multiviewer with Streaming Solution for Video Conferencing
- /// 1× 24V/2.7A DC Power Adapter
- /// 1× USB 3.0 Type-A to Type-B Cable
- /// 1× Operation Manual

4. SYSTEM REQUIREMENTS

- /// HDMI source equipment such as media players, video game consoles or set-top boxes.
- /// HDMI receiving equipment such as HDTVs, monitors or audio amplifiers.
- /// Personal computer (Windows 10 or macOS) with a USB 3.0 port and plenty of available hard drive space.

5. FEATURES

5.1 Multiviewer Component Features

- /// HDMI 2.0 and DVI 1.0 compliant (with the use of an HDMI-DVI adapter)
- /// HDCP 1.x and 2.2 compliant
- /// 4 HDMI inputs and 2 HDMI outputs
- /// Supports up to 4K UHD⁺ (18Gbps, 4K@50/60Hz 4:4:4, 8-bit) video input and output
 - Note: HDR bypass is not supported.*
- /// Seamless switching (no loss of sync to display) when switching sources in Matrix mode
- /// Supports up to four simultaneous, freely scalable, windows in multi-windowing modes
- /// Supports the ability to store a multi-window arrangement as a preset that can be recalled later
- /// Independent audio source selection and routing in all modes
- /// Inputs 1 & 2 support pass-through of many audio formats including 8 channel LPCM, Bitstream, and HD Bitstream (Inputs 3 & 4 are limited to 2 channel LPCM only)
- /// Each window can have a border with a selectable colour
- /// Uploadable and freely positionable graphic logo support
- /// Intuitive and easy adjustment of window size, position and settings in multi-window modes via the WebGUI
- /// Per-input EDID management with internal or external EDID options
- /// Controllable via front panel buttons, WebGUI, Telnet, and RS-232

5.2 Video Capture Component Features

- /// HDMI input and output with HDR, 3D & 4K@60Hz support, DVI 1.0 compatible
- /// HDCP 2.2 and HDCP 1.x compliant
- /// Supports up to 4K UHD⁺ (18Gbps, 4K@50/60Hz 4:4:4, 8-bit) video input and bypass output
- /// Supports Deep Colour input and bypass output up to 12-bit
- /// Supports 10-bit and 12-bit HDR (High Dynamic Range) input/bypass output
- /// Automatically scales 4K sources to 1080p for USB capture
- /// The video capture component of the unit is powered directly via USB 3.0

Note: When connected via USB 2.0, a Y-cable is required to provide additional power

- /// Supports video timing stabilization to help ensure a reliable and stable USB capture stream
- /// Capturing over USB 3.0 allows uncompressed video and audio data capture (up to 1080p, LPCM 2.0)
- /// Capturing over USB 2.0 requires the application of minimal MJPEG compression to the video and audio data (up to 1080p, LPCM 2.0)
- /// Supports capturing 2 channel digital audio from either HDMI (LPCM 2.0) or the 3.5mm analogue audio input (selectable via configuration software)
- /// Compliance with the UAC (USB Audio Class) and UVC (USB Video Class) standards, allows the video capture component of the unit to support most common capture and video streaming software

Note: Availability and access to the controllable features of the video capture component of the unit depend on the capture software used

- /// Support for the Free OBS (Open Broadcaster Software) streaming software which is available for Windows PC, macOS and Linux.

6. OPERATION CONTROLS AND FUNCTIONS

6.1 Front Panel

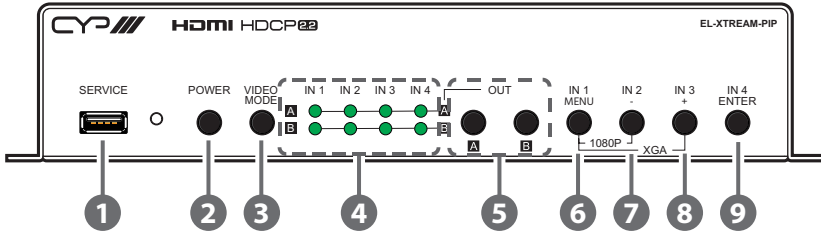

- 1 **SERVICE Port:** This port is reserved for firmware update and user EDID/ logo upload use only.
- 2 **POWER LED & Button:** Press this button to power the multiviewer component of the unit on (green LED) or place it into stand-by mode (red LED).

Note: Ethernet and RS-232 remain active when the unit is in stand-by mode. Does not affect the video capture component of this unit.

- 3 **VIDEO MODE Button:** Press this button to sequentially switch the multiviewer component's operational mode between Matrix, PiP, PoP, and Quad.
- 4 **OUT A~B/IN 1~4 LED Array:** In Matrix mode, these LED's indicate the currently selected sources (IN 1~4) routed to each of the two outputs (OUT A~B). When the multiviewer component is in a multi-windowing mode (PiP/PoP/Quad/ Preset) all LEDs will be illuminated simultaneously.

Note: When source selection is active the associated output's LED(s) will blink.

- 5 **OUT A/B Buttons:** In Matrix mode, either of these buttons to activate/ deactivate discrete source selection for the associated output. In multi- windowing modes (PiP/PoP/Quad/Preset) either button will activate/ deactivate sequential source selection for the 4 windows.

Note: These buttons only activate/deactivate the ability to change sources. Actual source selection is accomplished using the IN 1~4 buttons.

- 6 **IN 1/MENU Button:** When not in source selection mode, press to enter the OSD menu, or to back out from menu items. When source selection is active, pressing this button will either select input 1 (Matrix mode) or sequentially switch through all 4 inputs for window 1 (PiP/PoP/Quad/ Preset modes).

Note: Pressing "MENU" and "+" together will reset the output resolution to XGA (1024x768@60Hz). Pressing "MENU" and "-" together will reset the output resolution to 1080p@60Hz.

- 7 **IN 2/- (MINUS) Button:** When not in source selection mode, press to move down or adjust selections within OSD menus. When source selection is active, pressing this button will either select input 2 (Matrix mode) or sequentially switch through all 4 inputs for window 2 (PiP/PoP/Quad/Preset modes).
- 8 **IN 3/+ (PLUS) Button:** When not in source selection mode, press to move up or adjust selections within OSD menus. When source selection is active, pressing this button will either select input 3 (Matrix mode) or sequentially switch through all 4 inputs for window 3 (PiP/PoP/Quad/ Preset modes).
- 9 **IN 4/ENTER Button:** When not in source selection mode, press to confirm a selection within the OSD or to go deeper into a menu item. When source selection is active, pressing this button will either select input 4 (Matrix mode) or sequentially switch through all 4 inputs for window 4 (PiP/PoP/Quad/Preset modes).

6.2 Rear Panel

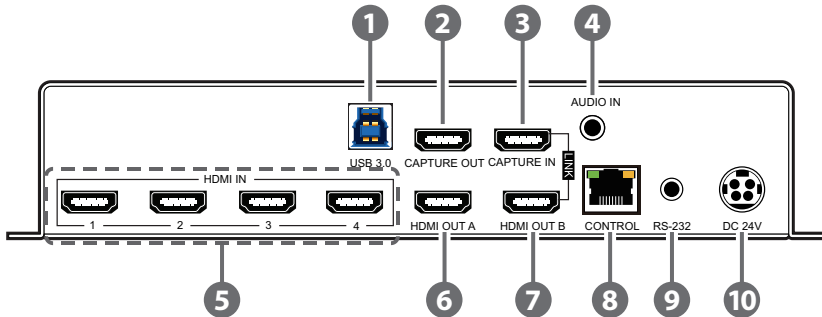

- 1 USB 3.0 Port:** Connect directly to a PC's USB 3.0 port to control and power the video capture component of the unit.

Note: If connected via USB 2.0, use of a Y-cable connected to 2 USB 2.0 ports is required in order to properly power the video capture component of the unit.
- 2 CAPTURE OUT Port:** The video bypass output from the video capture component of the unit. Connect to an HDMI TV, monitor or amplifier for digital video and audio output.
- 3 CAPTURE IN Port:** The video input for the video capture component of the unit. To capture video from the multiviewer component of the unit, connect this port to the HDMI OUT B port located directly below it.

Note: Capturing video sources containing HDCP protection is not supported. Only the bypass CAPTURE OUT port will be active with HDCP sources.
- 4 AUDIO IN Port:** Connect to the stereo analogue output of a device such as an audio player or PC for capture via USB 3.0.
- 5 HDMI IN 1~4 Ports:** Video inputs for the multiviewer component of the unit. Connect to HDMI source equipment such as players, game consoles, or set-top boxes.

Note: Audio support on inputs 3~4 is limited to 2 channel LPCM.
- 6 HDMI OUT A Port:** Primary HDMI output of the multiviewer component of the unit. Connect to HDMI TVs, monitors, or amplifiers for digital video and audio output.

- 7 **HDMI OUT B Port:** Secondary HDMI output of the multiviewer component of the unit. To capture video from the multiviewer component of the unit, connect this port to the CAPTURE IN port located directly above it.
- 8 **CONTROL Port:** Connect directly, or through a network switch, to your PC/laptop to control the multiviewer component of the unit via Telnet/WebGUI.
- 9 **RS-232 Port:** Connect directly to a PC, laptop, or other serial control device with a 3.5mm adapter cable to send RS-232 commands to control the multiviewer component of the unit.
- 10 **DC 24V Port:** Plug the 24V DC power adapter into this port and connect it to an AC wall outlet to power the multiviewer component of the unit.

Note: The video capture component of the unit receives power only from the USB 3.0 connection. Both must be connected to fully power the unit.

6.3 RS-232 Pinout and Defaults (Multiviewer)

Serial Port Default Settings	
Baud Rate	19200
Data Bits	8
Parity Bits	None
Stop Bits	1
Flow Control	None

3.5mm to DE-9
Adapter Cable

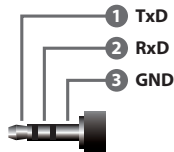

6.4 OSD Menu (Multiviewer)

All functions of this unit can be controlled by using the OSD (On Screen Display) which is activated by pressing the MENU button on the front of the unit. Use the + (PLUS), – (MINUS), and ENTER buttons to navigate the OSD menu. Press the MENU button to back out from any menu item and then press it again to close the menu.

MAIN MENU
Video Mode
Window Layout
Picture
Audio
Input EDID
HDCP Mode
Output Resolution
OSD Settings
Logo Settings
Ethernet
Preset
Setup
Information

The individual functions of the OSD will be introduced in the following section. Items marked in **BOLD** are the factory default settings.

VIDEO MODE	
2ND LEVEL	3RD LEVEL
Video Mode	Matrix
	PiP
	PoP
	QUAD
	Preset 1
	Preset 2
	Preset 3
	Preset 4
PiP/PoP/Quad/Preset Mode	
WIN 1 Source	In 1~4 (In 1)
WIN 2 Source	In 1~4 (In 2)
WIN 3 Source	In 1~4 (In 3)
WIN 4 Source	In 1~4 (In 4)
Matrix Mode	
OUT A Source	In 1~4 (In 1)
OUT B Source	In 1~4 (In 2)

- 1) **Video Mode:** Select the preferred operation mode of the unit.
Note: Selecting some modes will limit available features.
- 2) **WIN 1/2/3/4 Source:** Select the source for the specified window in multi- windowing modes (PiP, PoP, Quad).
- 3) **OUT A/B Source:** Select the source for the specified HDMI output when in Matrix mode.

WINDOW LAYOUT (Matrix Mode)	
2ND LEVEL	3RD LEVEL
Input Select	In 1~4 (In 1)
Aspect Ratio	FULL
	16:9
	16:10
	4:3
	Best Fit
Mirror	NO
	Yes
Border On/Off	On
	OFF
Border Colour	Black
	Red
	GREEN
	Blue
	Yellow
	Magenta
	Cyan
	White
	Dark Red
	Dark Green
	Dark Blue
	Dark Yellow
	Dark Magenta
	Dark Cyan
	Gray
Window Reset	NO
	Yes

- 1) **Input Select:** Select the input to modify.
Note: All settings are individually saved, per-input.
- 2) **Aspect Ratio:** Select a fixed aspect ratio for the currently selected window. Selecting the “Full” aspect ratio will stretch the source to fill the output, regardless of original aspect. Selecting “Best Fit” will automatically set the ratio based on the window’s current source resolution.
- 3) **Mirror:** Selecting “On” will flip the currently selected input horizontally.
- 4) **Border On/Off:** Enables or disable the colour border around the currently selected input.
- 5) **Border Colour:** Select the colour to use for the border of the currently selected input.
- 6) **Window Reset:** Reset the current input to its default settings.

WINDOW LAYOUT (PiP/PoP/Quad/Preset Modes)	
2ND LEVEL	3RD LEVEL
Window Select	Win 1~4 (Win 1)
Window On/Off	ON
	Off
Position X	0~Max H resolution
Position Y	0~Max V resolution
Size Width	1~Max H resolution
Size Height	1~Max V resolution
Priority	1~4 (4)
Aspect Ratio	FULL
	16:9
	16:10
	4:3
	Best Fit
	User
Mirror	NO
	Yes
Border On/Off	On
	OFF

WINDOW LAYOUT (PiP/PoP/Quad/Preset Modes)	
2ND LEVEL	3RD LEVEL
Border Colour	Black
	Red
	GREEN
	Blue
	Yellow
	Magenta
	Cyan
	White
	Dark Red
	Dark Green
	Dark Blue
	Dark Yellow
	Dark Magenta
	Dark Cyan
Gray	
Window Reset	NO
	Yes

- 1) **Window Select:** Select the window to modify.
Note: All settings are individually saved, per-window/per-mode.
- 2) **Window On/Off:** Enable or disable the currently selected window.
- 3) **Position X/Y:** Set the X and Y coordinate position of the upper left corner of the currently selected window.
- 4) **Size Width/Height:** Set the horizontal and vertical size of the currently selected window.
- 5) **Priority:** Select the layer priority of the currently selected window. Priority 1 is at the front and priority 4 is at the back.
- 6) **Aspect Ratio:** Select a fixed aspect ratio for the currently selected window. The aspect ratio will be based on the window's current height. Selecting the "Full" aspect ratio will return the window to the current mode's default size and shape for that window. Selecting "Best Fit" will automatically set the ratio based on the window's current

source resolution.

- 7) **Mirror:** Selecting “On” will flip the currently selected window horizontally.
- 8) **Border On/Off:** Enables or disable the colour border around the currently selected window.
- 9) **Border Colour:** Select the colour to use for the border of the currently selected window.
- 10) **Window Reset:** Reset the current window to its default settings based on the currently selected mode.

PICTURE	
2ND LEVEL	3RD LEVEL
Input Select	IN 1
	In 2
	In 3
	In 4
Contrast	0~100 (75)
Brightness	0~100 (50)
Saturation	0~100 (50)
Hue	0~100 (50)
Sharpness H	0~10 (10)
Sharpness V	0~10 (10)
Reset	NO
	Yes

- 1) **Input Select:** Select the input to modify.
- 2) **Contrast:** Set the overall contrast of the currently selected input.
- 3) **Brightness:** Set the overall brightness of the currently selected input.
- 4) **Saturation:** Set the overall saturation of the currently selected input.
- 5) **Hue:** Set the hue shift of the currently selected input.

- 6) **Sharpness H/V:** Set the amount of sharpness processing to apply to the currently selected input.
- 7) **Reset:** Reset the current input to its default settings.

AUDIO (Matrix Mode)	
2ND LEVEL	3RD LEVEL
OUT A Source	WINDOW
	In 1
	In 2
	In 3
	In 4
OUT A Mute	On
	OFF
OUT B Source	WINDOW
	In 1
	In 2
	In 3
	In 4
OUT B Mute	On
	OFF

- 1) **OUT A Source:** Select the audio source to pair with video output A.
- 2) **OUT A Mute:** Enable or disable muting audio output A.
- 3) **OUT B Source:** Select the audio source to pair with video output B.
- 4) **OUT B Mute:** Enable or disable muting audio output B.

AUDIO (PiP/PoP/Quad/Preset Modes)	
2ND LEVEL	3RD LEVEL
OUT A Source	WIN 1
	Win 2
	Win 3
	Win 4
	In 1
	In 2
	In 3
	In 4
OUT A Mute	On
	OFF
OUT B Source	WIN 1
	Win 2
	Win 3
	Win 4
	In 1
	In 2
	In 3
	In 4
OUT B Mute	On
	OFF

- 1) **OUT A Source:** Select the audio source to pair with video output A.
- 2) **OUT A Mute:** Enable or disable muting audio output A.
- 3) **OUT B Source:** Select the audio source to pair with video output B.
- 4) **OUT B Mute:** Enable or disable muting audio output B.

INPUT EDID	
2ND LEVEL	3RD LEVEL
EDID Mode	ALL
	Appoint
All EDID	FHD 2CH
	4K UHD 2CH
	4K UHD+ 2CH
	Sink OUT A
	Sink OUT B
	User 1
	User 2
	User 3
User 4	
IN 1 EDID	Same as [All EDID]
IN 2 EDID	Same as [All EDID]
IN 3 EDID	Same as [All EDID]
IN 4 EDID	Same as [All EDID]
User 1 Update	NO
	Yes
User 2 Update	NO
	Yes
User 3 Update	NO
	Yes
User 4 Update	NO
	Yes

- 1) **EDID Mode:** Select how to assign EDIDs to the unit’s inputs. Selecting “Appoint” allows for a different EDID to be assigned to each input, selecting “All” allows for a single EDID to be assigned to all inputs.
- 2) **All EDID:** Select the EDID to assign to all inputs.
Note: Only available in the “All” EDID Mode.
- 3) **In 1~4 EDID:** Select the EDID to assign to the specified input.
Note: Only available in the “Appoint” EDID Mode.
- 4) **User 1~4 EDID:** To update any of the unit’s 4 User EDIDs via USB, select “Yes” next to the appropriate User EDID and then insert a USB stick containing the new EDID into the Service port. The upload will occur immediately.
Note: The USB stick must contain, in the root directory, a compatible and properly named (EDID_User_.BIN) EDID file.*

HDCP MODE	
2ND LEVEL	3RD LEVEL
In 1~4	HDCP Support Off
	REFER TO SOURCE
	Refer to Display
OUT A	[Current HDCP status display]
OUT B	
Win 1	
Win 2	
Win 3	
Win 4	

- 1) **In 1~4:** Select the HDCP behavior for each input.
 - **HDCP Support Off:** Completely disables support for HDCP on that input.
 - **Refer to Source:** Makes the input port support the same HDCP version as required by the connected source.

■ **Refer to Display:** Makes the input support the HDCP version of the currently connected displays.

2) **HDCP Status:** Displays the current HDCP status of all sources and outputs.

OUTPUT RESOLUTION	
2ND LEVEL	
640×480p59	1920×1080p25
480p60	1920×1080p30
576p50	1920×1080p50
800×600p60	1920×1080P60
848×480p60	1920×1200RB
1024×768p60	3840×2160p24
1280×720p50	3840×2160p25
1280×720p60	3840×2160p30
1280×768p60	4K p24 (DCI)
1280×800p60	4K p25 (DCI)
1280×960p60	4K p30 (DCI)
1280×1024p60	4K p50 (DCI)
1360×768p60	4K p59 (DCI)
1366×768p60	4K p60 (DCI)
1400×1050p60	3840×2160p50
1440×900p60	3840×2160p59
1600×900p60RB	3840×2160p60
1600×1200p60	Native OUT A
1680×1050p60	Native OUT B
1920×1080p24	

1) **Output Resolution:** Select the preferred video output resolution.

Note: Both outputs always share the same resolution selection.

OSD SETTINGS	
2ND LEVEL	3RD LEVEL
Menu Position	TOP LEFT
	Top Right
	Bottom Right
	Bottom Left
Menu Timeout	Off
	5~60 (10)
Info. Timeout	Off
	5~60 (5)
Info. Display	ON
	Off
Transparency	OFF
	1~10
Background	Black
	GRAY
	Blue

- 1) **Menu Position:** Set the position of the OSD menu on the output.
- 2) **Menu Timeout:** Set the length of time, in seconds, that the OSD menu will continue to be displayed if there is no user input, or disable the timeout completely.
- 3) **Info. Timeout:** Set the length of time, in seconds, that the informational OSD will be displayed after a signal or source change, or disable the timeout completely.
- 4) **Info. Display:** Enable or disable the informational OSD.
- 5) **Transparency:** Set the transparency level of the background of the OSD menu.
- 6) **Background:** Set the colour of the background of the OSD menu.

LOGO SETTINGS	
2ND LEVEL	3RD LEVEL
Logo On/Off	On
	OFF
Position X	0~100 (10)
Position Y	0~100 (10)
Load Default Logo	NO
	Yes
Logo Update	NO
	Yes

- 1) **Logo On/Off:** Enable or disable displaying the logo graphic.
- 2) **Position X/Y:** Sets the position of the logo's upper left corner, within the output. The position values are a relative percentage of the available output resolution.
- 3) **Load Default Logo:** Selecting yes will reset the logo and install a default test image.

Note: The reset process can take a few moments. Progress information will be displayed on the OSD while the default logo is being installed. The unit will automatically reboot when it is finished.

- 4) **Logo Update:** To upload a graphic logo via USB, select "Yes" and then insert a USB stick containing the new logo graphic file (8-bit *.BMP format, 960×540 max resolution) into the Service port. The upload will occur immediately.

Note: The USB stick must contain, in the root directory, a compatible and properly named (Logo_User_.BMP) graphic file.*

ETHERNET	
2ND LEVEL	3RD LEVEL
IP Mode	STATIC
	DHCP
Static IP Config	
IP Address	x.x.x.x (192.168.1.50)
Subnet Mask	x.x.x.x (255.255.255.0)
Gateway	x.x.x.x (192.168.1.254)
Link Status	
IP Mode	[Current IP Mode]
IP Address	[Current Network Info]
Subnet Mask	
Gateway	
MAC Addr.	[Unit's MAC Address]

- 1) **IP Mode:** Set the unit's IP address mode to Static or DHCP.
- 2) **Static IP Config:** When the unit is in Static IP mode the IP address netmask and gateway addresses may be manually set here. Changes will occur immediately.

Note: Only editable in Static IP mode.

- 3) **Link Status:** Displays the unit's current IP configuration and the unit's MAC address.

PRESET	
2ND LEVEL	3RD LEVEL
Save	PRESET 1
	Preset 2
	Preset 3
	Preset 4
Recall	PRESET 1
	Preset 2
	Preset 3
	Preset 4

- 1) **Save Preset 1~4:** Select a preset and then press the “ENTER” button to store the unit’s current video window configuration to the currently selected preset.
- 2) **Recall Preset 1~4:** Select a preset and then press the “ENTER” button to activate the currently selected preset.

SETUP	
2ND LEVEL	3RD LEVEL
Auto Sync Off	ALWAYS ON
	5 sec.
	10 sec.
	15 sec.
	30 sec.
	1 min.
	1.5 min.
	2 min.
	2.5 min.
	3 min.
	5 min.
10 min.	

SETUP	
2ND LEVEL	3RD LEVEL
Firmware Update	NO
	Yes
User EDID Reset	NO
	Yes
Factory Reset	NO
	Yes

- 1) **Auto Sync Off:** Set the amount of time to continue outputting sync with a black screen if there are no live sources and no operations have been executed on the unit. Setting this to “Always On” forces the unit to always output sync.
- 2) **Firmware Update:** To update the firmware via USB, select “Yes” and then insert a USB stick containing the new firmware into the Service port. The upload will occur immediately.
Note: The USB stick must contain, in the root directory, a compatible and properly named (.BIN) firmware file.*
- 3) **User EDID Reset:** Select “Yes” to reset the unit’s User EDIDs to their factory default states.
- 4) **Factory Reset:** Select “Yes” to reset the unit to its factory default state. After the reset is complete, the unit will reboot automatically.

INFORMATION	
2ND LEVEL	3RD LEVEL
IN 1	[Current Input Resolutions]
IN 2	
IN 3	
IN 4	
OUT	[Current Output Resolution]
Video Mode	[Current Mode]
Sink A Native	[Native resolutions as reported by EDID]
Sink B Native	
Firmware	[Current Firmware Versions]
RX3/RX4 Firmware	

- 1) **Information:** Shows the currently detected details for all inputs and both outputs as well as listing the status of a few critical system settings and relevant firmware versions.

6.5 WebGUI Control (Multiviewer)

Device Discovery

Please obtain the “Device Discovery” software from your authorized dealer and save it in a directory where you can easily find it.

Connect the unit and your PC/Laptop to the same active network and execute the “Device Discovery” software. Click on “Find Devices on Internet” and a list of devices connected to the local network will show up indicating their current IP address.

Note: The unit’s default IP address is 192.168.1.50.

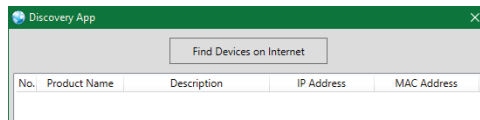

By clicking on one of the listed devices you will be presented with the network details of that particular device.

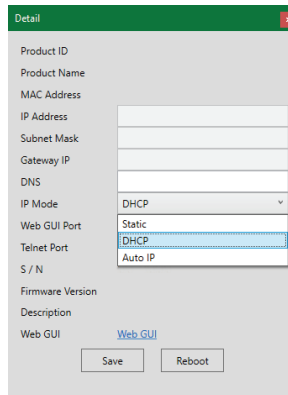

- 1) **IP Mode:** If you choose, you can alter the static IP network settings for the device, or switch the unit into DHCP mode to automatically obtain proper network settings from a local DHCP server. To switch to DHCP mode, please select DHCP from the IP mode drop-down, then click “Save” followed by “Reboot”.
- 2) **WebGUI Hotkey:** Once you are satisfied with the network settings, you may use them to connect via Telnet or WebGUI. The network information window provides a convenient link to launch the WebGUI directly.

WebGUI Overview

After connecting to the WebGUI's address in a web browser, the login screen will appear. Please enter the appropriate user name and password then click "Submit" to log in.

Note: The default user name and password is "admin".

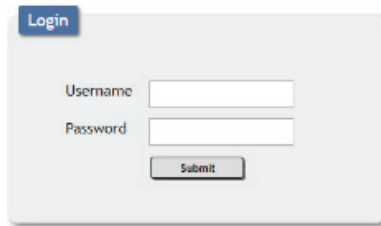

The login form is a light gray rounded rectangle. At the top left is a blue button labeled "Login". Below it are two white input fields: "Username" and "Password". At the bottom center is a gray button labeled "Submit".

On the left side of the browser you will see the following menu tabs where all primary functions of the unit are controllable via the built in WebGUI. The individual functions will be introduced in the following sections.

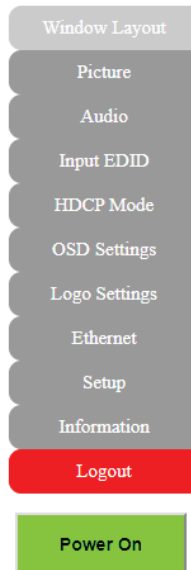

Clicking the red "Logout" tab will automatically log the currently connected user out of the WebGUI and return to login page. Clicking on the "Power" button will toggle the unit's current power state between on (green) and stand-by (red).

6.5.1 Upper Tab Windows

This upper section of the web interface is visible on every tab and provides control over the unit's operational mode, source selection, and output resolution as well as containing basic information about the currently connected source and display devices.

The screenshot shows three panels from a web interface:

- Source:** Four input fields, each showing '1920x1080P60'.
- Display:** A 'Resolution' dropdown set to '1920x1080p60', and two 'Sink A Native' and 'Sink B Native' fields, both showing '3840x2160P60'.
- Video Mode:** A 'Video Mode' dropdown set to 'Quad', and four window selection fields (Win 1-4) and two output selection fields (Out A, Out B), all set to 'IN 1' and 'IN 2' respectively.

1) **Source:** This section displays the currently detected resolution for the sources connected to each input.

2) Display:

- **Resolution:** Use the dropdown to select the preferred output resolution for the unit.

Note: Both outputs will always share the same output resolution, even in Matrix mode.

- **Sink A/B Native:** Displays the native resolution of both connected displays as reported by their respective EDIDs.

3) Video Mode:

- **Video Mode:** Use the dropdown to select the unit's operational mode. Available options are: Matrix, PiP, PoP, Quad, and Presets 1~4.

Note: Switching between video modes will cause the output to briefly go to black, but audio output will not be affected if the selected audio source is the same in both modes.

- **Win 1~4:** Select the video source to use in each window of a multi-window mode (PiP/PoP/Quad/Presets).

Note: Only available when a multi-window mode is active.

- **Out A~B:** Select the video source for each output in Matrix mode.

Note: Only available when Matrix mode is active.

6.5.2 Window Layout Tab

This tab provides control over the position, size, aspect, priority, and other settings of each window in multi-viewer modes. A graphical representation of the layout is also provided. When the unit is in Matrix mode, only a limited selection of controls are available.

Note: Only the information from the currently selected window/input is displayed. A window's position and size cannot exceed the current output resolution.

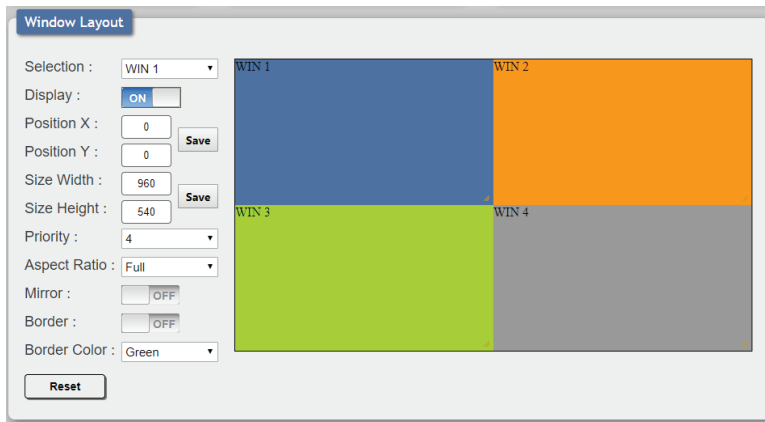

- 1) Selection:** In multi-windowing modes, use the dropdown to select the window to modify. In Matrix mode select the input to modify.

Note: Changes made while a "Preset" video mode is selected will automatically be applied and saved to that preset.

- 2) Display:** Enable or disable the currently selected window.

Note: Not available in Matrix mode.

- 3) Position X/Y:** Set the X and Y coordinate position of the upper left corner of the currently selected window. Click on the "Save" button, after making changes, to make them active.

Note: Not available in Matrix mode.

- 4) Size Width/Height:** Set the horizontal and vertical size of the currently selected window. Click on the "Save" button, after making changes, to make them active.

Note: Not available in Matrix mode.

- 5) **Priority:** Select the layer priority of the currently selected window. Priority 1 is at the front and priority 4 is at the back.

Note: Not available in Matrix mode.

- 6) **Aspect Ratio:** Use the dropdown to select a fixed aspect ratio for the currently selected window or input. Available options are: Full, 16:9, 16:10, 4:3, Best Fit, and User. In multi-windowing modes the aspect ratio will be based on the window's current height. Selecting the "Full" aspect ratio will return the window to the current mode's default size and shape for that window. Selecting "Best Fit" will automatically set the ratio based on the window's current source resolution.

Note: The "User" aspect ratio is not available in Matrix mode.

- 7) **Mirror:** Turning this switch on will flip the currently selected window/input horizontally.

- 8) **Border:** This switch enables or disables the colour border around the currently selected window or input.

- 9) **Border Colour:** Use the dropdown to select the colour to use for the border of the currently selected window/input. Available colors are: Black, red, green, blue, yellow, magenta, cyan, white, dark red, dark green, dark blue, dark yellow, dark magenta, dark cyan, gray.

- 10) **Reset:** Reset the current window/input to its default settings based on the currently selected mode.

- 11) **Visual Layout Window:** When in a multi-windowing mode, individual windows may be selected, moved and resized simply by clicking and dragging on them in the layout window. To select a window, click on it and the information will be displayed on the left. Click and drag the center of a window to reposition it. Click and drag the bottom right corner of a window to manually resize it. The results of a change will be displayed on the outputs as soon as the mouse button has been released.

Note: Not available in Matrix mode.

6.5.3 Picture Tab

This tab provides controls over each input's contrast, brightness, saturation, hue, and sharpness levels.

Note: All picture settings are per-input and are mode-independent.

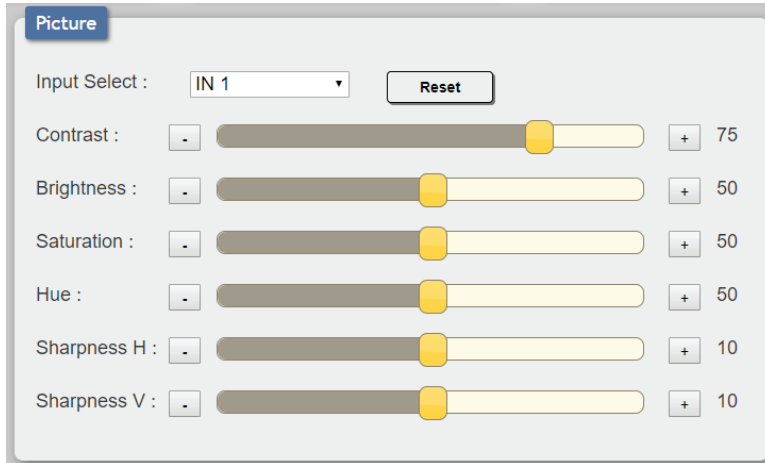

- 1) **Input Select:** Use the dropdown to select the input to modify.
- 2) **Reset:** Reset the current input to its default settings.
- 3) **Contrast:** This slider provides control over the overall contrast of the currently selected source video.
- 4) **Brightness:** This slider provides control over the overall brightness of the currently selected source video.
- 5) **Saturation:** This slider provides control over the overall saturation of the currently selected source video.
- 6) **Hue:** This slider provides control over the hue shift of the currently selected source video.
- 7) **Sharpness H/V:** These sliders provide control over the amount of sharpness processing to apply to the currently selected source video.

Note: Horizontal and vertical processing is independently controlled, providing finer control over the image quality.

6.5.4 Audio Tab

This tab provides control over the audio output behavior of the unit, including routing selection and muting.

Note: Due to Matrix mode only supporting a single “window”, changing modes between a multi-windowing mode and Matrix mode when an audio source is set to windows 2~4 will result in the source reverting to window 1.

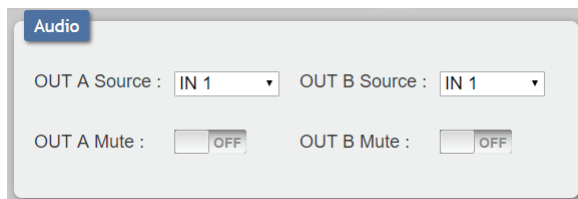

- 1) OUT A Source:** Use the dropdown to choose the audio source to pair with video output A.
 - **IN 1~4:** Always use the audio from the specified input.
 - **WIN 1~4:** Always use audio from the source currently displayed in the specified window.
Note: WIN 2~4 is not available as a source in Matrix mode.
- 2) OUT B Source:** Use the dropdown to choose the audio source to pair with video output A.
 - **IN 1~4:** Always use the audio from the specified input.
 - **WIN 1~4:** Always use audio from the source currently displayed in the specified window.
Note: WIN 2~4 is not available as a source in Matrix mode.
- 3) OUT A Mute:** Click the switch to toggle between muted and unmuted audio on output A.
- 4) OUT B Mute:** Click the switch to toggle between muted and unmuted audio on output A.

6.5.5 Input EDID Tab

This unit provides the option of three standard EDIDs, two sink sourced EDIDs and four user uploaded EDIDs that can be assigned to all inputs at the same time, or to each input independently.

Note: In most cases, assigning a new EDID to an input will cause the affected input to briefly blink out while the source adapts to the new information.

- 1) **EDID Mode:** Use the dropdown to select how to assign EDIDs to the unit's inputs. Selecting "Appoint" allows for a different EDID to be assigned to each input, selecting "All" allows for a single EDID to be assigned to all inputs.
- 2) **All EDID:** Select the EDID to assign to all inputs. Click on the "Save" button to activate the selected EDID across all inputs.
Note: Only available in "All" EDID Mode.
- 3) **IN 1~4 EDID:** Select the EDID to assign to the specified input. Click on the associated "Save" button to activate the selected EDID.
Note: Only available in "Appoint" EDID Mode.
- 4) **User 1~4 Update:** To update any of the unit's 4 User EDIDs, click the "Choose File" button to open the file selection window and then select the EDID file (*.bin format) located on your local PC. After selecting the file, click the "Update" button to begin the EDID upload process.

This unit provides the following 3 default EDIDs:

Unit's default EDIDs	
FHD 2CH	1920×1080p@60Hz (4.95Gbps) & 8-bit colour, LPCM 2.0
UHD 2CH	3840×2160p@30Hz (10.2Gbps) & Deep Colour (8/10/12-bit), LPCM 2.0
UHD+ 2CH	3840×2160p@60Hz (18Gbps) & Deep Colour (8/10/12-bit), LPCM 2.0

Note: In some rare cases it is possible for custom or external EDIDs to cause compatibility issues with certain sources. If this happens, it is recommended to switch to one of the 3 default EDIDs for maximum compatibility.

6.5.6 HDCP Mode & Status Tab

This tab provides control over the HDCP settings for all inputs and displays the current status for all inputs and outputs.

1) **HDCP Mode Input 1~4:** Use the dropdown to select the HDCP behavior for each input.

- **HDCP Support Off:** Completely disables support for HDCP on that input.
- **Refer to Source:** Makes the input port support the same HDCP version as required by the connected source.
- **Refer to Display:** Makes the input support the HDCP version of the currently connected displays.

2) **HDCP Status:** Displays the current status for all inputs and outputs.

6.5.7 OSD Settings Tab

This tab provides control over the behavior of the OSD menu and informational display.

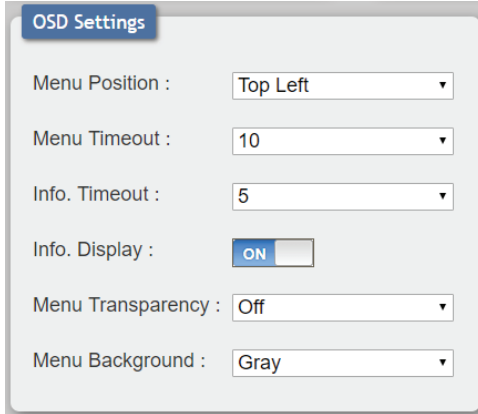

The screenshot shows the OSD Settings tab with the following configuration:

- Menu Position : Top Left
- Menu Timeout : 10
- Info. Timeout : 5
- Info. Display : ON
- Menu Transparency : Off
- Menu Background : Gray

- 1) Menu Position:** Use the dropdown to set the position of the OSD menu on the output. Available choices are: Top Left, Top Right, Bottom Right, and Bottom Left.
- 2) Menu Timeout:** Set the length of time, in seconds, that the OSD menu will continue to be displayed if there is no user input, or disable the timeout completely.
- 3) Info. Timeout:** Set the length of time, in seconds, that the informational OSD will be displayed after a signal or source change, or disable the timeout completely.
- 4) Info. Display:** Enable or disable the informational OSD.
- 5) Menu Transparency:** Set the transparency level of the background of the OSD menu with a range from Off (opaque) to 10 (mostly transparent).
- 6) Menu background:** Set the colour of the background of the OSD menu. Available choices are: Gray, Black, and Blue.

6.5.8 Logo Settings Tab

This tab provides control over the user uploaded logo graphic. Controls include positioning, an uploading a new logo directly from the WebGUI and an option to reset the logo to a built in default image that can be used for testing.

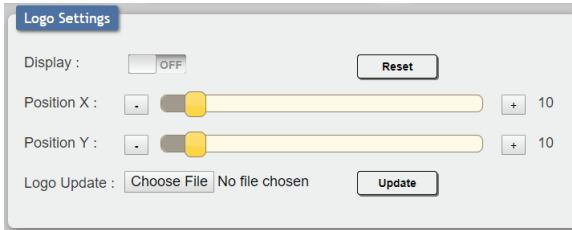

- 1) **Display:** Enable or disable displaying the logo graphic.
- 2) **Reset:** Resets the logo and installs a default test image.
Note: The reset process can take a few moments. Progress information will be displayed on the OSD while the default logo is being installed. The unit will automatically reboot when it is finished.
- 3) **Position X/Y:** Sets the position of the logo's upper left corner, within the output. The position values are a relative percentage of the available output resolution.
- 4) **Logo Update:** To upload a graphic logo, please click the "Choose File" button to open the file selection window and then select the graphic logo file (8-bit *.bmp format, 960x540 max resolution) located on your local PC. After selecting the file, click the "Update" button to upload the logo to the unit.

Note: The upload process can take a while, depending on the size of the logo. Progress information will be displayed on the OSD while the logo is being installed. The unit will automatically reboot when it is finished.

6.5.9 Ethernet Tab

This tab provides controls to change the network settings for the unit. You can manually set the IP address, netmask and gateway address in “Static IP” mode, or you can obtain an IP address automatically by enabling DHCP.

Note: The unit’s default Static IP address is 192.168.1.50. If the IP address is changed then the IP address required for WebGUI/Telnet access will also change accordingly.

The screenshot shows the Ethernet configuration interface. At the top, the 'Ethernet' tab is selected. Below it, the 'IP Mode' is set to 'STATIC'. The 'Static IP Config' section contains three rows of input fields: 'Static IP Address' (192, 168, 1, 50), 'Static Subnet Mask' (255, 255, 255, 0), and 'Static Gateway' (192, 168, 1, 254). A 'Save' button is located to the right of the gateway fields. Below this is the 'Link Status' section, which displays the current configuration: 'IP Mode' (Static), 'IP Address' (192, 168, 1, 50), 'Subnet Mask' (255, 255, 255, 0), 'Gateway' (192, 168, 1, 254), and 'MAC Address' (represented by six empty boxes).

- 1) **IP Mode:** Click this button to toggle between the Static IP and DHCP modes. In DHCP mode, the unit will attempt to automatically obtain its IP configuration details from a local DHCP server. In Static mode the unit will use the manually assigned IP configuration information.
- 2) **Static IP Config:** When the unit is in Static IP mode the IP address, netmask and gateway addresses may be manually set here. Click “Save” to apply and use the newly entered address.
- 3) **Link Status:** Displays the unit’s current IP configuration and the unit’s MAC address.

6.5.10 Setup Tab

Provides a way to update firmware and reset various sections within the unit. Control over the unit's Auto Sync Off feature, storing/recalling presets as well as configuring the WebGUI login settings is also provided here.

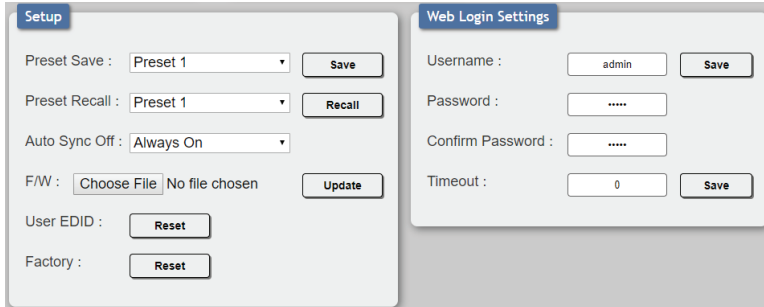

- 1) **Preset Save:** Select a preset from the dropdown list and then click the “Save” button to store the unit’s current video window configuration to the currently selected preset.
- 2) **Preset Recall:** Select a preset from the dropdown list and then click the “Recall” button to activate the currently selected preset.

Note: this can also be achieved by selecting a Preset from the Video Mode dropdown at the top of the WebGUI.

- 3) **Auto Sync Off:** Sets the amount of time to continue outputting sync with a black screen if there are no live sources and no operations have been executed on the unit. Setting this to “Always On” forces the unit to always output sync.
- 4) **Firmware Update:** To update the unit’s firmware, click the “Choose File” button to open the file selection window and then select the firmware update file (*.bin format) located on your local PC. After selecting the file, click the “Upgrade” button to begin the firmware update process. After the upgrade is complete, the unit will reboot automatically.
- 5) **User EDID Reset:** Press this button to reset the unit’s User EDIDs to their factory default states.
- 6) **Factory Reset:** Press this button to reset the unit to its factory default state. After the reset is complete, the unit will reboot automatically.

7) **Web Login Settings:** WebGUI login settings can be set here.

- **Username/Password:** To change the login username and password, enter the new information in the spaces provided and press "Save".

Note: The default user name and password is "admin".

- **Timeout:** Set the length of time to wait, in minutes, before logging out a user due to inactivity. Setting this to "0" disables the timeout.

6.5.11 Information Tab

This tab displays the unit's serial number as well as the current firmware versions.

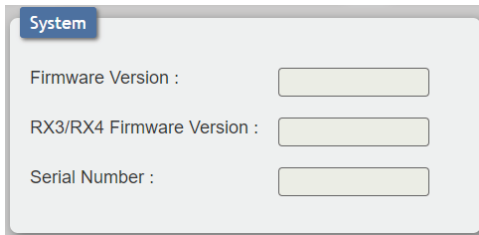

System

Firmware Version :

RX3/RX4 Firmware Version :

Serial Number :

6.6 Video Capture Control & Configuration

6.6.1 USB Video Capture Configuration

The USB Video Capture Control software provides control over a selection of basic functions of the unit, including: audio source, HDCP, video settings and volume. An option to return the unit to its factory defaults is also provided.

Note: Please obtain the “USB Video Capture Control” software from your authorized dealer and save it in a directory where you can easily find it. Both Windows and macOS versions are available.

To use the software, connect the unit to your PC via the provided USB 3.0 cable and then execute the control application. A configuration window, similar to the screenshot below, will appear. All changes made to the video capture signal via this app will take effect immediately.

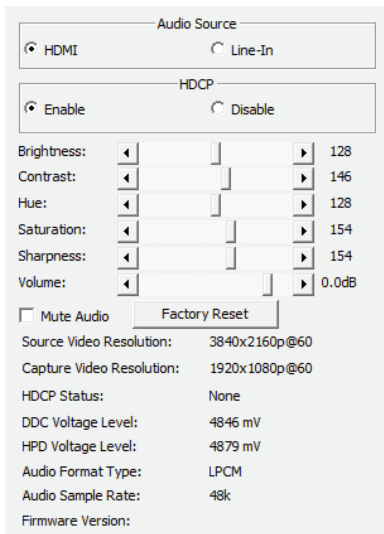

- 1) **Audio Source:** Switch the audio source to record between the embedded HDMI audio and the analogue line input.

Note: Only LPCM 2.0 audio can be recorded. Bitstream audio is not supported.

2) HDCP: Enable or disable HDCP support on the HDMI input.

Note: Disabling HDCP support may enable the recording of the output of some source devices (typically PCs/Macs) that enable HDCP encryption even when it is not required by the current video content. Once HDCP support is disabled on this unit, the connected device should automatically switch to a non-HDCP mode as long as the playing content allows it. Certain other source devices (such as most major video game consoles) enable HDCP output by default, but will not automatically disable HDCP based on the connected device's reported capabilities. In order to enable video recording of the output of these devices, HDCP must be manually disabled using the game console's own system menu.

3) ProcAmp Controls: This section provides direct control over a variety of video and audio settings when video capture is active.

Note: Changes to these settings have no impact on the HDMI bypass output signal.

■ **Brightness:** Provides control over the overall brightness of the captured video.

■ **Contrast:** Provides control over the overall contrast of the captured video.

■ **Hue:** Provides control over the hue shift of the captured video.

■ **Saturation:** Provides control over the colour saturation level of the captured video.

■ **Sharpness:** Provides control over the amount of sharpness processing to apply to the captured video.

■ **Volume:** Provides control over the audio volume of the captured video.

■ **Mute Audio:** Mutes or unmutes audio in the captured video.

4) Factory Reset: Press the "Factory Reset" button to reset the unit to its factory default state. After the reset is complete, the unit will reboot automatically.

5) Detailed Signal Information: This section provides detailed information about the current source and capture resolution, HDCP state, DDC and hot-plug voltages, audio format and sample rate, and current firmware version.

6.6.2 Video Capture

Video capture and recording/streaming is accomplished using 3rd party software. The choice of video capture software is entirely up to the user. This unit adheres to the UAC (USB Audio Class) and UVC (USB Video Class) standards, allowing the unit to support most common video capture, chat, or streaming software, including support for the Free OBS (Open Broadcaster Software) streaming software, among many other choices. Availability and access to the controllable features of the unit (such as capture resolution, recording storage format, etc.) depends on which features the specific capture software package chooses to expose.

Note: Many source devices (such as most major video game consoles) force HDCP output by default, even when it is not required by the content currently being output. In order to enable video recording of the output of these devices, HDCP must be manually disabled using the game console's own system menu.

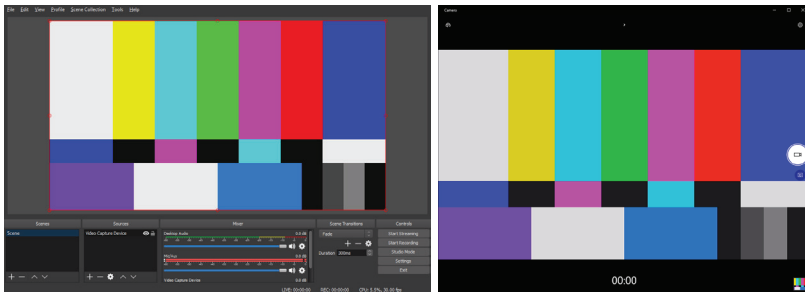

6.7 Telnet Control (Multiviewer)

Before attempting to use Telnet control, please ensure that both the unit and the PC are connected to the same active networks.

Start your preferred Telnet/Console client, or use the built in client provided by most modern computer operating systems. After starting the client, connect by using the current IP address of the unit and port 23 (if the communication port number used by the unit has not been changed previously). This will connect us to the unit we wish to control and commands may now be entered directly.

Note 1: If the IP address of the unit is changed then the IP address required for Telnet access will also change accordingly.

Note 2: The default IP address is 192.168.1.50 and the default communication port is 23.

6.8 Serial and Telnet Commands (Multiviewer)

COMMAND	
Description and Parameters	
help ←	Show the full command list.
help N1 ←	Show details about the specified command. N1 = {Command}
? ←	Show the full command list.
? N1 ←	Show details about the specified command. N1 = {Command}
get fw ver ←	Show the unit's current firmware version.

COMMAND					
Description and Parameters					
get command ver ↵	Show the unit's current command version.				
get mac addr ↵	Show the unit's MAC address.				
get model name ↵	Show the unit's model name.				
get model type ↵	Show the unit's product type.				
set feedback broadcast N1 ↵	<p>Enable or disable the broadcast of console command feedback.</p> <p>Available values for N1:</p> <table> <tr> <td>ON</td> <td>[Enabled]</td> </tr> <tr> <td>OFF</td> <td>[Disabled]</td> </tr> </table>	ON	[Enabled]	OFF	[Disabled]
ON	[Enabled]				
OFF	[Disabled]				
get feedback broadcast ↵	Show the current console command feedback broadcast state.				
set ip mode N1 ↵	<p>Set the IP address assignment mode.</p> <p>Available values for N1:</p> <table> <tr> <td>STATIC</td> <td>[Static IP mode]</td> </tr> <tr> <td>DHCP</td> <td>[DHCP mode]</td> </tr> </table>	STATIC	[Static IP mode]	DHCP	[DHCP mode]
STATIC	[Static IP mode]				
DHCP	[DHCP mode]				
get ip mode ↵	Show the current IP address assignment mode.				
get ipconfig ↵	Show the unit's current IP configuration information.				

COMMAND	
Description and Parameters	
get ipaddr ↵	Show the unit's current IP address.
get netmask ↵	Show the unit's current netmask.
get gateway ↵	Show the unit's current gateway address.
set static ipaddr N1 ↵	Set the unit's static IP address. N1 = X.X.X.X [X = 0~255, IP address]
get static ipaddr ↵	Show the unit's static IP address.
set static netmask N1 ↵	Set the unit's static IP address. N1 = X.X.X.X [X = 0~255, Netmask]
get static netmask ↵	Show the unit's static netmask.
set static gateway N1 ↵	Set the unit's static IP address. N1 = X.X.X.X [X = 0~255, Gateway address]
get static gateway ↵	Show the unit's static gateway address.

COMMAND	
Description and Parameters	
set webgui username N1 ↵	
Set the WebGUI login username.	
N1 = {Username}	[16 characters max]
get webgui username ↵	
Show the current WebGUI login username	
set webgui password N1 ↵	
Set the WebGUI login password.	
N1 = {Password}	[16 characters max]
get webgui password ↵	
Show the current WebGUI login password.	
set webgui login timeout N1 ↵	
Set the WebGUI inactivity timeout value.	
N1 = 0~240	[Minutes]
get webgui login timeout ↵	
Show the current WebGUI inactivity timeout value.	
set telnet login N1 ↵	
Enable or disable allowing Telnet logins.	
Available values for N1 :	
ON	[Enabled]
OFF	[Disabled]
get telnet login ↵	
Show the current state of Telnet login allowance.	

COMMAND	
Description and Parameters	
set telnet username N1 ←	
Set the Telnet login username.	
N1 = {Username}	[16 characters max]
get telnet username ←	
Show the current Telnet login username.	
set telnet password N1 ←	
Set the Telnet login password.	
N1 = {Password}	[16 characters max]
get telnet password ←	
Show the unit's Telnet access port.	
set window layout mode N1 ←	
Set the window layout mode.	
Available values for N1 :	
0	[Matrix mode]
1	[PiP mode]
2	[PoP mode]
3	[Quad mode]
4	[Preset 1]
5	[Preset 2]
6	[Preset 3]
7	[Preset 4]
get window layout mode ←	
Show the window current layout mode.	

COMMAND	
Description and Parameters	
set window N1 route N2↵	<p>Set the input to route to the specified window.</p> <p>N1 = 1~4 [Window number]</p> <p>N2 = 1~4 [Input port]</p> <p><i>Note: Valid in multi-windowing modes only.</i></p>
get window N1 route↵	<p>Show the input currently routed to the specified window.</p> <p>N1 = 1~4 [Window number]</p> <p><i>Note: Valid in multi-windowing modes only.</i></p>
set out N1 route N2↵	<p>Route the specified input to the specified output.</p> <p>N1 = A~B [Output port]</p> <p>N2 = 1~4 [Input port]</p> <p><i>Note: Valid in matrix mode only.</i></p>
get out N1 route↵	<p>Show the current input routed to the specified output.</p> <p>N1 = A~B [Output port]</p> <p><i>Note: Valid in matrix mode only.</i></p>
set window N1 display N2↵	<p>Enable or disable the specified window.</p> <p>N1 = 1~4 [Window number]</p> <p>Available values for N2:</p> <p>ON [Enabled]</p> <p>OFF [Disabled]</p> <p><i>Note: Valid in multi-windowing modes only.</i></p>

COMMAND**Description and Parameters****get window N1 display**↵

Show the visibility status of the specified window,

N1 = 1~4 [Window number]

Note: Valid in multi-windowing modes only.

set window N1 hposition N2↵

Set the horizontal position of the specified window.

N1 = 1~4 [Window number]

N2 = 0~{Max res} [Horizontal size]

Note: Valid in multi-windowing modes only.

get window N1 hposition↵

Show the current horizontal position of the specified window.

N1 = 1~4 [Window number]

Note: Valid in multi-windowing modes only.

set window N1 vposition N2↵

Set the vertical position of the specified window.

N1 = 1~4 [Window number]

N2 = 0~{Max res} [Vertical size]

Note: Valid in multi-windowing modes only.

get window N1 vposition↵

Show the current vertical position of the specified window.

N1 = 1~4 [Window number]

Note: Valid in multi-windowing modes only.

COMMAND	
Description and Parameters	
get window N1 priority ↵↵	
Show the current priority of the specified window.	
N1 = 1~4	[Window number]
<i>Note: Valid in multi-windowing modes only.</i>	
set window N1 aspect N2 ↵↵	
Set the aspect of the specified window.	
N1 = 1~4	[Window number]
Available values for N2 :	
1	[Full]
2	[16:9]
3	[16:10]
4	[4:3]
5	[Best Fit]
6	[User]
get window N1 aspect ↵↵	
Show the current aspect of the specified window.	
N1 = 1~4	[Window number]
set window N1 mirror N2 ↵↵	
Set the mirror mode of the specified window.	
N1 = 1~4	[Window number]
Available values for N2 :	
ON	[Enabled]
OFF	[Disabled]
get window N1 mirror ↵↵	
Show the current mirror mode of the specified window.	
N1 = 1~4	[Window number]

COMMAND	
Description and Parameters	
set window N1 border N2 ↵	
Set the border mode of the specified window.	
N1 = 1~4	[Window number]
Available values for N2 :	
ON	[Enabled]
OFF	[Disabled]
get window N1 border ↵	
Show the current border mode of the specified window.	
N1 = 1~4	[Window number]
set window N1 border color N2 ↵	
Set the border colour of the specified window.	
N1 = 1~4	[Window number]
Available values for N2 :	
1	[Black]
2	[Red]
3	[Green]
4	[Blue]
5	[Yellow]
6	[Magenta]
7	[Cyan]
8	[White]
9	[Dark Red]
10	[Dark Green]
11	[Dark Blue]
12	[Dark Yellow]
13	[Dark Magenta]
14	[Dark Cyan]
15	[Gray]

COMMAND	
Description and Parameters	
set in N1 saturation N2	←
Set the saturation level of the specified input.	
N1 = 1~4	[Input port]
N2 = 0~100	[Saturation level]
get in N1 saturation	←
Show the current saturation level of the specified input.	
N1 = 1~4	[Input port]
set in N1 hue N2	←
Set the hue value of the specified input.	
N1 = 1~4	[Input port]
N2 = 0~100	[Hue value]
get in N1 hue	←
Show the current hue value of the specified input.	
N1 = 1~4	[Input port]
set in N1 sharpness h N2	←
Set the horizontal sharpness level of the specified input.	
N1 = 1~4	[Input port]
N2 = 0~20	[Horizontal sharpness level]
get in N1 sharpness h	←
Show the current horizontal sharpness level of the specified input.	
N1 = 1~4	[Input port]

COMMAND**Description and Parameters****set in N1 sharpness v N2**

Set the vertical sharpness level of the specified input.

N1 = 1~4 [Input port]

N2 = 0~20 [Vertical sharpness level]

get in N1 sharpness v

Show the current vertical sharpness level of the specified input.

N1 = 1~4 [Input port]

set in N1 picture reset

Set the picture settings reset.

N1 = 1~4 [Input port]

set audio out N1 mute N2

Enable or disable muting the specified audio output.

N1 = A~B [Output port]

Available values for **N2**:

ON [Mute]

OFF [Unmute]

get audio out N1 mute

Show the current mute state of the specified output.

N1 = A~B [Output port]

COMMAND	
Description and Parameters	
set audio out N1 route N2 ↵	
Route the specified audio source to the specified audio output.	
N1 = A~B	[Output port]
Available values for N2 :	
1	[Input 1]
2	[Input 2]
3	[Input 3]
4	[Input 4]
5	[Window 1]
6	[Window 2]
7	[Window 3]
8	[Window 4]
get audio out N1 route ↵	
Show the current audio source routed to the specified audio output.	
N1 = A~B	[Output port]
set all in edid mode N1 ↵	
Select the EDID management mode to use (All or Appoint) for all inputs.	
Available values for N1 :	
1	[All mode]
2	[Appoint mode]
get all in edid mode ↵	
Show the current EDID management mode used by all inputs.	

COMMAND**Description and Parameters****set all in edid N1** ←

Set the EDID to use when the “All” EDID mode is active.

Available values for **N1**:

1	[FHD 2-Channel]
2	[4K UHD 2-Channel]
3	[4K UHD+ 2-Channel]
7	[User 1]
8	[User 2]
9	[User 3]
10	[User 4]
15	[Sink A]
16	[Sink B]

get all in edid ←

Show the current EDID used by the “All” EDID mode.

set in N1 edid N2 ←

Set the EDID to use on the specified input.

N1 = 1~4 [Input port]

Available values for **N2**:

1	[FHD 2-Channel]
2	[4K UHD 2-Channel]
3	[4K UHD+ 2-Channel]
7	[User 1]
8	[User 2]
9	[User 3]
10	[User 4]
15	[Sink A]
16	[Sink B]

COMMAND	
Description and Parameters	
get in N1 edid ↵	
Show the EDID currently being used on the specified input.	
N1 = 1~4	[Input port]
set user edid N1 update ↵	
Upload a new EDID for use as the specified User EDID.	
N1 = 1~4	[User EDID number]
set in N1 hdcp mode N2 ↵	
Set the HDCP behavior of the specified input.	
N1 = 1~4	[Input port]
Available values for N2 :	
0	[HDCP off]
1	[Refer to Source]
2	[Refer to Display]
get in N1 hdcp mode ↵	
Show the current HDCP behavior used by the specified input.	
N1 = 1~4	[Input port]

COMMAND**Description and Parameters****set out A timing N1** ←

Set the output resolution to use for both outputs.

Available values for **N1**:

0	[640x480p59]
1	[480p60]
2	[576p50]
3	[800x600p60]
4	[848x480p60]
5	[1024x768p60]
6	[1280x720p50]
7	[1280x720p60]
8	[1280x768p60]
9	[1280x800P60]
10	[1280x960p60]
11	[1280x1024p60]
12	[1360x768P60]
13	[1366x768p60]
14	[1400x1050p60]
15	[1440x900p60]
16	[1600x900p60rb]
17	[1600x1200p60]
18	[1680x1050p60]
19	[1920x1080p24]
20	[1920x1080p25]
21	[1920x1080p30]
22	[1920x1080p50]
23	[1920x1080p60]
24	[1920x1200rb]
25	[3840x2160p24]
26	[3840x2160p25]
27	[3840x2160p30]
28	[4K p24 DCI]
29	[4K p25 DCI]
30	[4K p30 DCI]
31	[4K p50 DCI]

COMMAND	
Description and Parameters	
32	[4K p59 DCI]
33	[4K p60 DCI]
34	[3840x2160p50]
35	[3840x2160p59]
36	[3840x2160p60]
37	[Native OUT A]
38	[Native OUT B]
get out A timing ↵	
Show the current resolution used by both outputs.	
set out A osd position N1 ↵	
Set the OSD menu location.	
Available values for N1 :	
0	[Top Left]
1	[Top Right]
2	[Bottom Right]
3	[Bottom Left]
get out A osd position ↵	
Show the current OSD menu location.	
set out A osd timeout N1 ↵	
Set the OSD menu's timeout value (in seconds).	
Available values for N1 :	
OFF	[Disabled]
5~60	[Timeout in seconds]
get out A osd timeout ↵	
Show the current OSD menu's timeout value.	

COMMAND	
Description and Parameters	
set out A osd info display N1 ←	
Enable or disable the info OSD.	
Available values for N1 :	
ON	[Enabled]
OFF	[Disabled]
get out A osd info display ←	
Show the current info OSD state.	
set out A osd info timeout N1 ←	
Set the OSD info's timeout value (in seconds).	
Available values for N1 :	
OFF	[Disabled]
5~60	[Timeout in seconds]
get out A osd info timeout ←	
Show the current OSD info's timeout value.	
set out A osd transparency N1 ←	
Set the transparency level of the OSD.	
N1 = 0~10	[Transparency level]
set out A osd background color N1 ←	
Set the colour of the background of the OSD banner.	
Available values for N1 :	
0	[Black]
1	[Gray]
2	[Blue]

COMMAND	
Description and Parameters	
get out A osd background color ←	Show the current colour of the background of the OSD banner on the specified output.
set out A osd logo display N1 ←	Enable or disable the graphical logo overlay. Available values for N1 : ON [Enabled] OFF [Disabled]
get out A osd logo display ←	Show the current state of the graphical logo overlay.
set out A osd logo hposition N1 ←	Set the horizontal position of the graphical logo overlay. N1 = 0~100 [Horizontal position]
get out A osd logo hposition ←	Show the current horizontal position of the graphical logo overlay.
set out A osd logo vposition N1 ←	Set the vertical position of the graphical logo overlay. N1 = 0~100 [Vertical position]
get out A osd logo vposition ←	Show the current vertical position of the graphical logo overlay.
set osd logo default ←	Resets the logo and installs a default test image.
set osd logo update ←	Initiates the logo update process via USB.

COMMAND	
Description and Parameters	
set save preset N1 ↵	
Saves the current unit's settings to the specified preset.	
N1 = 1~4	[Preset number]
set auto sync off N1 ↵	
Enable or disable the Auto Sync Off function and set the timeout length.	
Available values for N1 :	
0	[Always on]
1	[5 seconds]
2	[10 seconds]
3	[15 seconds]
4	[30 seconds]
5	[1 minute]
6	[1.5 minutes]
7	[2 minutes]
8	[2.5 minutes]
9	[3 minutes]
10	[5 minutes]
11	[10 minutes]
get auto sync off ↵	
Show the current Auto Sync Off settings.	
set firmware update ↵	
Initiates the firmware update process via USB.	
set factory user edid default ↵	
Restore the unit's User EDIDs to their factory default settings.	
set factory ipconfig default ↵	
Reset the unit's network settings to the factory defaults.	

COMMAND
Description and Parameters
set factory default ↵ Restore the unit's settings, except for User EDIDs, to their factory default settings.

Note: Commands will not be executed unless followed by a carriage return. Commands are not case-sensitive.

7. CONNECTION DIAGRAM

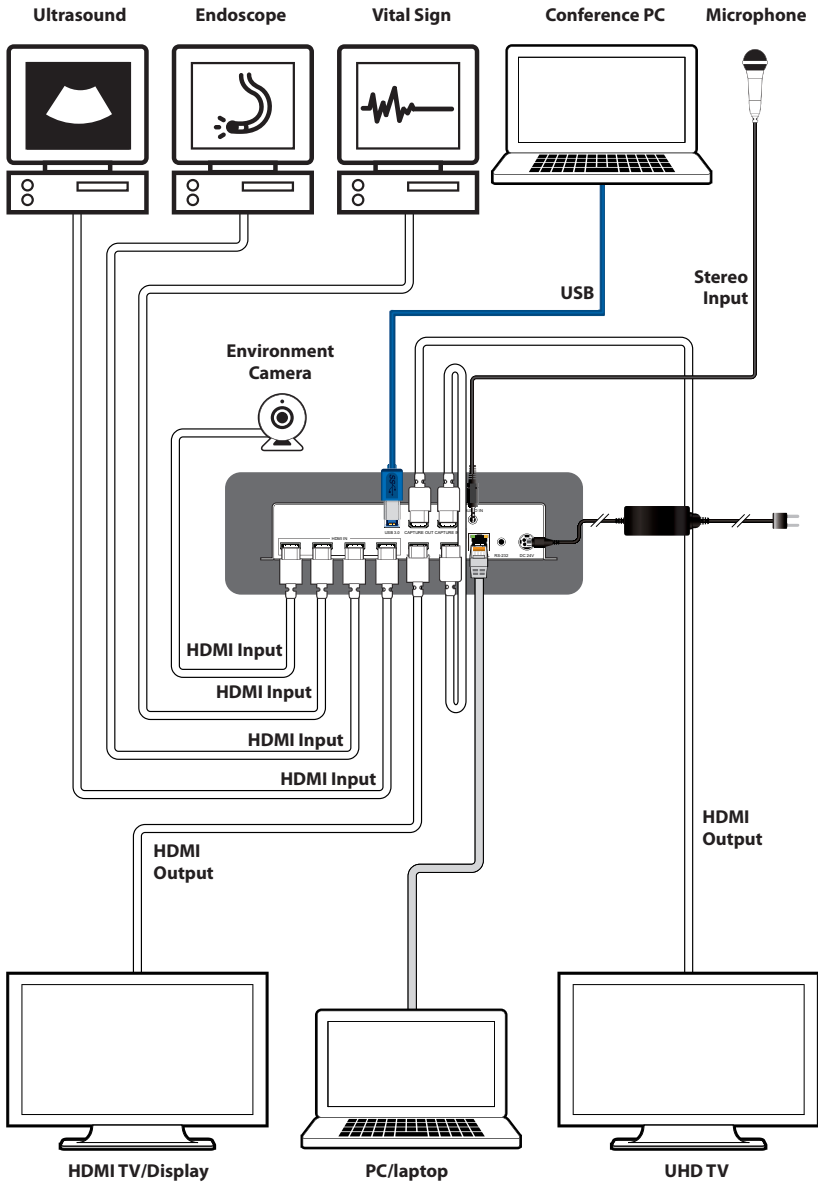

8. SPECIFICATIONS

8.1 Technical Specifications

HDMI Bandwidth	18Gbps
Input Ports	5×HDMI (Type-A) 1×Stereo Audio (3.5mm)
Output Ports	3×HDMI (Type-A) 1×USB 3.0 (Type-B)
Control Ports	1×RS-232 (3.5mm) 1×IP Control (RJ-45)
Service Port	1×USB 2.0 (Type-A)
Baud Rate	19200
Power Supply (Multiviewer)	24V/2.7A DC (US/EU standards, CE/FCC/UL certified)
Power Supply (Vid Capture)	Powered via USB 3.0 (0.9A minimum)
ESD Protection (HBM)	±8kV (Air Discharge) ±4kV (Contact Discharge)
Dimensions (W×H×D)	213.5mm×43mm×158mm [Case Only] 231.5mm×44mm×161mm [All Inclusive]
Weight	1,135g
Chassis Material	Metal (Steel)
Chassis Colour	White
Operating Temperature	0°C – 40°C/32°F – 104°F
Storage Temperature	-20°C – 60°C/-4°F – 140°F
Relative Humidity	20 – 90% RH (Non-condensing)
Power Consumption	15.3W (Multiviewer) 7.15W (Video Capture)

8.2 Video Specifications

Supported Resolutions (Hz)	Multiviewer		Video Capture	
	HDMI Input	HDMI Output	HDMI Input	HDMI Bypass Output
720×400p@70/85	✓	x	✓	✓
640×480p@60/72/75/85	✓	60Hz	✓	✓
720×480i@60	✓	x	✓	✓
720×480p@60	✓	✓	✓	✓
720×576i@50	✓	x	✓	✓
720×576p@50	✓	✓	✓	✓
800×600p@56/60/72/75/85	✓	60Hz	✓	✓
848×480p@60	✓	x	✓	✓
1024×768p@60/70/75/85	✓	60Hz	✓	✓
1152×864p@75	✓	x	✓	✓
1280×720p@50/60	✓	✓	✓	✓
1280×768p@60/75/85	✓	60Hz	✓	✓
1280×800p@60/75/85	✓	60Hz	✓	✓
1280×960p@60/85	✓	60Hz	✓	✓
1280×1024p@60/75/85	✓	60Hz	✓	✓
1360×768p@60	✓	✓	✓	✓
1366×768p@60	✓	✓	✓	✓
1400×1050p@60	✓	✓	✓	✓
1440×900p@60/75	✓	60Hz	✓	✓
1600×900p@60RB	✓	✓	✓	✓
1600×1200p@60	✓	✓	✓	✓
1680×1050p@60	✓	✓	✓	✓

Supported Resolutions (Hz)	Multiviewer		Video Capture	
	HDMI Input	HDMI Output	HDMI Input	HDMI Bypass Output
1920×1080i@50/60	✓	×	✓	✓
1920×1080p@24/25/30	✓	✓	✓	✓
1920×1080p@50/60	✓	✓	✓	✓
1920×1200p@60RB	✓	✓	✓	✓
2560×1440p@60RB	✓	×	✓	✓
2560×1600p@60RB	✓	×	✓	✓
2048×1080p@24/25/30	✓	×	✓	✓
2048×1080p@50/60	✓	×	✓	✓
3840×2160p@24/25/30	✓	✓	✓	✓
3840×2160p@50/60 (4:2:0)	✓	×	✓	✓
3840×2160p@24, HDR10	×	×	✓	✓
3840×2160p@50/60 (4:2:0), HDR10	×	×	✓	✓
3840×2160p@50/60	✓	✓	✓	✓
4096×2160p@24/25/30	✓	✓	✓	✓
4096×2160p@50/60 (4:2:0)	✓	×	✓	✓
4096×2160p@24, HDR10	×	×	✓	✓
4096×2160p@50/60 (4:2:0), HDR10	×	×	✓	✓
4096×2160p@50/60	✓	✓	✓	✓

8.3 Audio Specifications

8.3.1 Digital Audio

Multiviewer HDMI Inputs 1~2/ Outputs A~B	
LPCM	
Max Channels	8 Channels
Sampling Rate (kHz)	32, 44.1, 48, 88.2, 96, 176.4, 192
Bitstream	
Supported Formats	Standard & High-Definition
Multiviewer HDMI Inputs 3~4	
LPCM	
Max Channels	2 Channels
Sampling Rate (kHz)	48
Bitstream	
Supported Formats	None

Video Capture HDMI Input / Output	
LPCM	
Max Channels	8 Channels
Sampling Rate (kHz)	32, 44.1, 48, 88.2, 96, 176.4, 192
Bitstream	
Supported Formats	Standard & High-Definition
Video Capture USB Output	
LPCM	
Max Channels	2 Channels
Sampling Rate (kHz)	32, 44.1, 48, 88.2, 96, 176.4, 192
Bitstream	
Supported Formats	None

8.3.2 Analogue Audio

Video Capture Analogue Input	
Max Audio Level	2Vrms
Impedance	10kΩ
Type	Unbalanced

8.4 Cable Specifications

Cable Length	1080p		4K30	4K60
	8-bit	12-bit	(4:4:4) 8-bit	(4:4:4) 8-bit
High Speed HDMI Cable				
HDMI Input	15m	10m	5m	3m
HDMI Output	15m	10m	5m	3m

Bandwidth Category Examples:

1080p (FHD Video)

- Up to 1080p@60Hz, 12-bit colour
- Data rates lower than 5.3Gbps or below 225MHz TMDS clock

4K30 (4K UHD Video)

- 4K@24/25/30Hz & 4K@50/60Hz (4:2:0), 8-bit colour
- Data rates higher than 5.3Gbps or above 225MHz TMDS clock but below 10.2Gbps

4K60 (4K UHD+ Video)

- 4K@50/60Hz (4:4:4, 8-bit)
- 4K@50/60Hz (4:2:0, 10-bit HDR)
- Data rates higher than 10.2Gbps

9. ACRONYMS

ACRONYM	COMPLETE TERM
ADC	Analogue-to-Digital Converter
ASCII	American Standard Code for Information Interchange
Cat.5e	Enhanced Category 5 cable
Cat.6	Category 6 cable
Cat.6A	Augmented Category 6 cable
Cat.7	Category 7 cable
CLI	Command-Line Interface
dB	Decibel
DHCP	Dynamic Host Configuration Protocol
DVI	Digital Visual Interface
EDID	Extended Display Identification Data
Gbps	Gigabits per second
GUI	Graphical User Interface
HDCP	High-bandwidth Digital Content Protection
HDMI	High-Definition Multimedia Interface
HDR	High Dynamic Range
HDTV	High-Definition Television
IP	Internet Protocol
kHz	Kilohertz
LAN	Local Area Network
LED	Light-Emitting Diode
LPCM	Linear Pulse-Code Modulation
MAC	Media Access Control
MHz	Megahertz

ACRONYM	COMPLETE TERM
OSD	On-Screen Display
PiP	Picture in Picture
PoP	Picture outside of Picture
SNR	Signal-to-Noise Ratio
TCP	Transmission Control Protocol
THD+N	Total Harmonic Distortion plus Noise
TMDs	Transition-Minimized Differential Signaling
UAC	USB Audio Class
4K UHD	4K Ultra-High-Definition (10.2Gbps max)
4K UHD⁺	4K Ultra-High-Definition (18Gbps max)
UHDTV	Ultra-High-Definition Television
USB	Universal Serial Bus
UVC	USB Video Class
VGA	Video Graphics Array
WUXGA (RB)	Widescreen Ultra Extended Graphics Array (Reduced Blanking)
XGA	Extended Graphics Array
Ω	Ohm



CYP (UK) Ltd., Unit 7, Shepperton Business Park, Govett Avenue, Shepperton,
Middlesex, TW17 8BA

Tel: +44 (0) 20 3137 9180 | Fax: +44 (0) 20 3137 6279

Email: sales@cypeurope.com

www.cypeurope.com

v1.00