



HDBT[®]
HDCP22



EL-2600V

**HDBaseT Transmitter with Trigger Control
4K UHD+ HDMI/DP/VGA/USB**

OPERATION MANUAL

DISCLAIMERS

The information in this manual has been carefully checked and is believed to be accurate. CYP (UK) Ltd assumes no responsibility for any infringements of patents or other rights of third parties which may result from its use.

CYP (UK) Ltd assumes no responsibility for any inaccuracies that may be contained in this document. CYP (UK) Ltd also makes no commitment to update or to keep current the information contained in this document.

CYP (UK) Ltd reserves the right to make improvements to this document and/or product at any time and without notice.

COPYRIGHT NOTICE

No part of this document may be reproduced, transmitted, transcribed, stored in a retrieval system, or any of its part translated into any language or computer file, in any form or by any means—electronic, mechanical, magnetic, optical, chemical, manual, or otherwise—without express written permission and consent from CYP (UK) Ltd.

© Copyright 2019 by CYP (UK) Ltd.

All Rights Reserved.

Version 1.1

TRADEMARK ACKNOWLEDGMENTS

All products or service names mentioned in this document may be trademarks of the companies with which they are associated.

SAFETY PRECAUTIONS

Please read all instructions before attempting to unpack, install or operate this equipment and before connecting the power supply.

Please keep the following in mind as you unpack and install this equipment:

- Always follow basic safety precautions to reduce the risk of fire, electrical shock and injury to persons.
- To prevent fire or shock hazard, do not expose the unit to rain, moisture or install this product near water.
- Never spill liquid of any kind on or into this product.
- Never push an object of any kind into this product through any openings or empty slots in the unit, as you may damage parts inside the unit.
- Do not attach the power supply cabling to building surfaces.
- Use only the supplied power supply unit (PSU). Do not use the PSU if it is damaged.
- Do not allow anything to rest on the power cabling or allow any weight to be placed upon it or any person walk on it.
- To protect the unit from overheating, do not block any vents or openings in the unit housing that provide ventilation and allow for sufficient space for air to circulate around the unit.

REVISION HISTORY

VERSION NO.	DATE	SUMMARY OF CHANGE
v1.00	13/08/2019	First release

CONTENTS

1. Introduction	6
2. Applications	6
3. Package Contents	7
4. System Requirements	7
5. Features	8
6. Operation Controls and Functions	9
6.1 Front Panel	9
6.2 Rear Panel.....	11
6.3 IR Cable Pinouts	13
6.4 RS-232 Pinout and Defaults	13
6.5 WebGUI Control	14
6.6 Telnet Control.....	26
6.7 RS-232 and Telnet Commands.....	27
7. Connection Diagram	40
8. Specifications	41
8.1 Technical Specifications	41
8.2 Video Specifications.....	43
8.3 Audio Specifications.....	45
8.4 Cable Specifications	47
8.5 HDBaseT Features.....	48
9. Acronyms	49

1. INTRODUCTION

This HDBaseT 2.0 Transmitter is designed for use in environments needing a wide range of flexibility when it comes to inputs, outputs, and control. The three most common video input interfaces (HDMI, DisplayPort, and VGA w/stereo audio) are included, providing the ultimate in source compatibility and flexibility. The HDMI and DisplayPort inputs support resolution/timing up to a maximum of 4K@60Hz (4:4:4, 8-bit) which is converted, when appropriate and necessary, for transmission over HDBaseT. The selected source (video & audio) can be transmitted over Cat.6/7 cable up to 100m along with bi-directional Ethernet, RS-232, USB, and IR. Due to the matrixing capability of this unit, any source may also be selected for independent output over the local HDMI output. The included microphone input, with optional 48V/5V phantom power support, feeds directly into a DSP mixer, allowing for powerful presentations with live voice-overs mixed with the source's original audio or even an impromptu karaoke session.

When paired with this unit's standard Receiver, up to 3 switchable USB 2.0 host (Type B) connections are available (2 on the Transmitter, 1 on the Receiver) which connect to 6 USB 2.0 (Type A) device ports (3 on the Transmitter, 3 on the Receiver) for a multi-source, bi-directional, and highly flexible KVM configuration (Note: Only 1 USB host may be active at a time). This Transmitter also provides an interface for a remote control keypad, or trigger interface, which can be easily installed within a podium or table in a conference room or classroom.

This Transmitter may be powered locally using a standard power supply, or it can be powered via PoH (Power over HDBaseT) provided by a compatible Receiver (PSE), allowing for greater flexibility within different installation scenarios. This unit is controllable via front panel controls, WebGUI, Telnet, Triggers, and RS-232.

2. APPLICATIONS

- /// Lecture room display and control
- /// Showroom display and control
- /// Meeting room presentation and control
- /// Classroom display and control

3. PACKAGE CONTENTS

- /// 1×HDMI/DP/VGA/USB to HDMI/HDBaseT Transmitter
- /// 1×3-pin terminal block
- /// 1×5-pin terminal block
- /// 1×3.5mm to IR Blaster Cable
- /// 1×3.5mm to IR Extender Cable
- /// 1×Shockproof Feet (Set of 4)
- /// 1×Operation Manual

4. SYSTEM REQUIREMENTS

- /// HDMI, DisplayPort or VGA source equipment such as media players, video game consoles, PCs, or set-top boxes.
- /// A compatible HDBaseT receiver with PoH (PSE) support is recommended.
- /// HDMI receiving equipment such as an HDTV, monitor or audio amplifier.
- /// The use of Premium High Speed HDMI cables, and industry standard Cat.6, Cat.6a or Cat.7, is highly recommended.

5. FEATURES

- /// HDMI and DisplayPort with 3D, & 4K video support (18Gbps)
- /// HDCP 1.x & 2.2 compliant
- /// HDBaseT 2.0 compatible
- /// Selectable HDMI, DisplayPort, and VGA inputs
- /// HDMI and DisplayPort inputs support resolutions up to 4K@60Hz (4:4:4, 8-bit)
- /// VGA input supports resolutions up to 1080p60/WUXGA (RB)
- /// HDMI output supports resolutions up to 4K@60Hz (4:4:4, 8-bit)
- /// HDBaseT output supports resolutions up to 4K@60Hz (4:2:0, 8-bit) or 4K@30Hz (4:4:4, 8-bit). 4K@50/60Hz (4:4:4, 8-bit) or 4K@any (10/12-bit) sources will be automatically colour space converted to fit within the available bandwidth
- /// 4x2 matrix switching (HDMI and HDBaseT outputs are independent)
- /// Supported HDBaseT features: HD video and audio, 100BaseT Ethernet, PoH, and control (bi-directional IR/RS-232/USB pass-through)
- /// Supports pass-through of 8 channel LPCM, Bitstream & HD Bitstream audio formats
- /// Balanced analogue stereo audio breakout
- /// Microphone input supports optional 48V or 5V phantom power
- /// Microphone input feeds into a DSP mixer allowing adjustable mix level controls
- /// Flexible USB host selection using front panel buttons
- /// Multiple USB hosts may be connected at once (up to 3 total, between the Tx and a compatible Rx unit) with a single selected host active at a time
- /// Supports extended keypad (trigger) control for easy, single button, function activation (optional equipment)
- /// Supports local power, or power via PoH from a connected Receiver (PSE) (compatible Receivers only)
- /// Controllable via front panel buttons, WebGUI, Telnet, Triggers, and RS-232

6. OPERATION CONTROLS AND FUNCTIONS

6.1 Front Panel

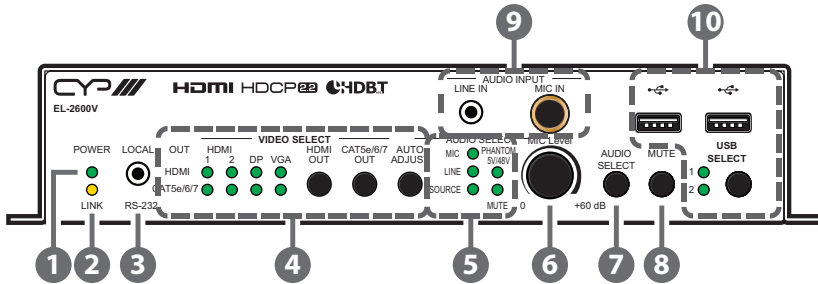

- 1 POWER LED:** This LED will illuminate to indicate the unit is on and receiving power.
- 2 LINK LED:** This LED will illuminate solidly when a live connection with a compatible Receiver is active.
- 3 LOCAL RS-232 Port:** Connect directly to a PC, laptop, or other serial control device with a 3.5mm adapter cable to send RS-232 commands to control the unit.

- 4 HDMI OUT Button & LEDs:** Press this button to sequentially switch through the available inputs for the HDMI output. The HDMI OUT LED will illuminate to indicate which source is currently selected.

CAT5e/6/7 OUT Button & LEDs: Press this button to sequentially switch through the available inputs for the HDMI output. The CAT5e/6/7 OUT LED will illuminate to indicate which source is currently selected.

AUTO ADJUST Button: Pressing this button activates the VGA Auto Adjust function, forcing the unit to re-detect the VGA signal's positioning values.

Note: Only valid when a VGA source is selected.

- 5 MIC LED:** This LED illuminates to indicate that the MIC IN input is currently active on the CAT5e/6/7 output.

LINE LED: This LED illuminates to indicate that the LINE IN input is currently active on the CAT5e/6/7 output.

SOURCE LED: This LED illuminates to indicate that the selected video

source's audio is currently active on the CAT5e/6/7 output.

Note: When the mixer is active, more than one LED to be lit at the same time. Multiple LEDs indicate which audio sources are currently being combined.

PHANTOM 5V/48V LED: This LED illuminates to indicate if phantom power (5V or 48V) is currently active on the microphone input.

MUTE LED: This LED illuminates to indicate that the analogue output is currently muted.

- 6 MIC LEVEL Knob:** Turn this knob to manually set the microphone input's volume level.

Note: This dial is only active when the volume control toggle is set to "Panel" in the WebGUI.

- 7 AUDIO SELECT Button:** Press this button to sequentially switch between the audio source(s) to route to the CAT5e/6/7 and Analogue Audio outputs. The LEDs will illuminate to indicate which sources are currently selected or being mixed.

- 8 MUTE Button:** Press to toggle between muting and unmuting the analogue audio output.

- 9 LINE IN Port:** Connect to the stereo analogue output of a device such as an audio player or PC.

MIC IN Port: Connect to a standard microphone using a 6.35mm plug.

Note: If the microphone requires 5V or 48V phantom power, it must be activated in the WebGUI.

- 10 USB Device Ports (Type A):** Connect directly to standard USB devices such as a mouse, keyboard or flash drive to extend their USB functionality to the currently active USB Host Port.

- 11 USB SELECT Button & LEDs:** Press this button to sequentially switch through the available USB Host Ports. The LEDs will illuminate to indicate which USB Host Port is currently selected. If both LEDs are off, the USB Host Port on the connected Receiver is active.

Note: Changing the USB host will force the HDBaseT connection to briefly disconnect while it reconfigures. The connected host (PC, Laptop, etc.) may also take a moment to detect all available devices.

6.2 Rear Panel

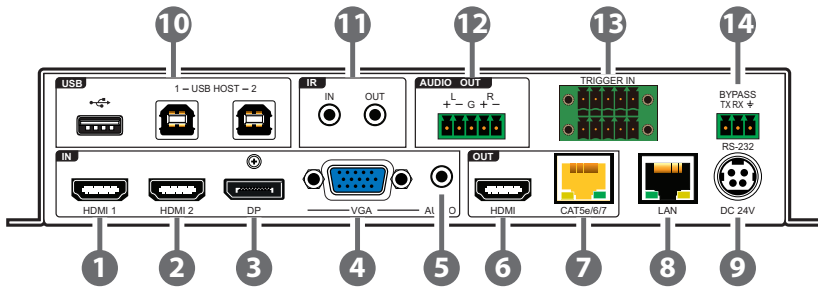

- 1 **HDMI 1 IN Port:** Connect to HDMI source equipment such as a media player, game console, or set-top box.
- 2 **HDMI 2 IN Port:** Connect to HDMI source equipment such as a media player, game console, or set-top box.
- 3 **DP IN Port:** Connect to DisplayPort source equipment such as a media player, PC, or set-top box.
- 4 **VGA IN Port:** Connect to VGA source equipment such as a PC or laptop.
- 5 **L/R Port:** Connect to the stereo analogue output of the device connected to the VGA input port.
- 6 **HDMI OUT Port:** Connect to an HDMI TV, monitor, or amplifier for digital video and audio output.
- 7 **CAT5e/6/7 Port:** Connect to a compatible HDBaseT Receiver with a single Cat.5e/6/7 cable for transmission of all data signals. Power via PoH will also be supplied to this unit when connected to a compatible PSE Receiver.
- 8 **LAN Port:** Connect directly, or through a network switch, to your PC/laptop to control the unit via Telnet/WebGUI and to extend the network across the HDBaseT connection.
- 9 **DC 24V Port:** Plug the 24V DC power adapter into this port and connect it to an AC wall outlet for power. (Optional. Unit may also be powered via PoH)
- 10 **USB Device Port (Type A):** Connect directly to a standard USB device such as a mouse, keyboard or flash drive to extend their USB functionality to the currently active USB Host Port.

USB Host Ports (Type B): Connect directly to a standard USB host

such as a PC or laptop to extend their USB functionality to all currently connected USB devices.

Note: Only one USB Host Port may be active at a time.

- 11 IR IN Port:** Connect to the provided IR Extender to receive IR control signals and extend them to devices connected to the other end of the HDBaseT connection. Ensure that the remote being used is within direct line-of-sight of the IR Extender.

IR OUT Port: Connect to the provided IR Blaster to transmit IR signals from the other end of the HDBaseT connection to devices within direct line-of-sight of the IR Blaster.

- 12 ANALOGUE OUT Terminal Block:** Connect to powered speakers or an amplifier using a 5-pin terminal block for balanced stereo analogue audio output.
- 13 TRIGGER IN Terminal Block:** Connect to the Trigger Control Keypad (OPTIONAL) or any device with trigger switch functionality such as window security alarms, motion detectors, door switches, etc. Each of the 8 triggers will activate an assigned unit function when triggered.

Note: A minimum of 5V DC is required to activate a trigger.

- 14 BYPASS RS-232 Terminal Block:** Connect to a PC, laptop, or other serial control device with a 3-pin adapter cable for the extension of RS-232 signals to the Receiver.

6.3 IR Cable Pinouts

IR Blaster Cable

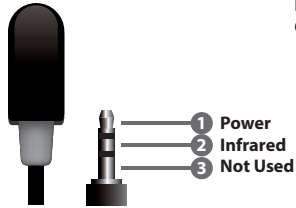

IR Extender Cable

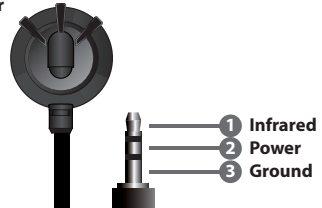

6.4 RS-232 Pinout and Defaults

Serial Port Default Settings	
Baud Rate	19200
Data Bits	8
Parity Bits	None
Stop Bits	1
Flow Control	None

3-pin Terminal Block

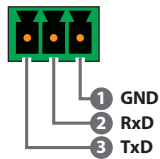

3.5mm to DE-9 Adapter Cable

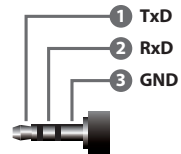

6.5 WebGUI Control

Device Discovery

Please obtain the “Device Discovery” software from your authorised dealer and save it in a directory where you can easily find it.

Connect the unit and your PC/Laptop to the same active network and execute the “Device Discovery” software. Click on “Find Devices on Network” and a list of devices connected to the local network will show up indicating their current IP address.

Note: The unit’s default IP address is 192.168.1.50.

Find Devices on Network			
Product Name	Description	IP Address	MAC Address

By clicking on one of the listed devices you will be presented with the network details of that particular device.

Product ID	
Product Name	
MAC Address	00:00:00:00:00:00
IP Address	<input type="text"/>
Subnet Mask	<input type="text"/>
Gateway IP	<input type="text"/>
DNS	<input type="text"/>
IP Mode	Static
Web GUI Port	Static
Telnet Port	8020
S / N	0
Firmware Version	
Hardware Version	
Description	
Web GUI	Web GUI
Save	Reboot

- 1) IP Mode:** If you choose, you can alter the static IP network settings for the device, or switch the unit into DHCP mode to automatically obtain proper network settings from a local DHCP server. To switch to DHCP mode, please select DHCP from the IP mode drop-down, then click “Save” followed by “Reboot”.
- 2) WebGUI Hotkey:** Once you are satisfied with the network settings, you may use them to connect via Telnet or WebGUI. The network information window provides a convenient link to launch the WebGUI directly.

WebGUI Overview

After connecting to the WebGUI's address in a web browser, the login screen will appear. Please enter the appropriate user name and password then click "Submit" to log in.

Note: The default user name and password is "admin".

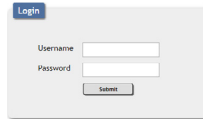

A screenshot of a login form. At the top left is a blue tab labeled "Login". Below it are two input fields: "Username" and "Password". At the bottom center is a "Submit" button.

On the left side of the browser you will see the following menu tabs where all primary functions of the unit are controllable via the built in WebGUI. The individual functions will be introduced in the following sections.



Clicking the red "Logout" tab will automatically log the currently connected user out of the WebGUI and return to login page. Clicking on the "Receiver Webpage" button will open a new webpage showing the WebGUI for the connected Receiver.

6.5.1 Video Select Tab

This tab provides A/V routing control, auto switch controls, and I/O renaming options.

To assign a new A/V route, please click the button of the Output you wish to route a source to on the left and then click on the button of the preferred Input port on the right. Selecting both Outputs simultaneously is possible.

As you select each button they will become yellow. The new route will become active immediately and the routing information displayed on the buttons will change accordingly.

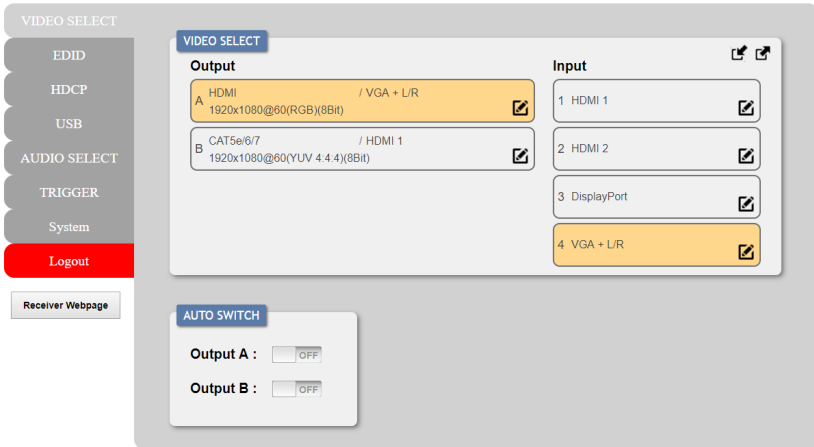

1) Video Select:

- **Output:** Buttons for selecting the Output (A or B) to route A/V Inputs to. Details about the Output names and currently selected Input are also displayed here. Clicking on the “edit” icon (✎) opens up the Edit Output window which allows for changing the Output’s name.
- **Input:** Buttons for selecting the Input (1 through 4) to route to the selected Output. The current Input names is also displayed here. Clicking on the “edit” icon (✎) opens up the Edit Input window which allows for changing the Input’s name.

- 2) **Auto Switch:** Auto switching may be enabled or disabled individually for each Output. Click on the On/Off slider to toggle the behavior of the selected Output.

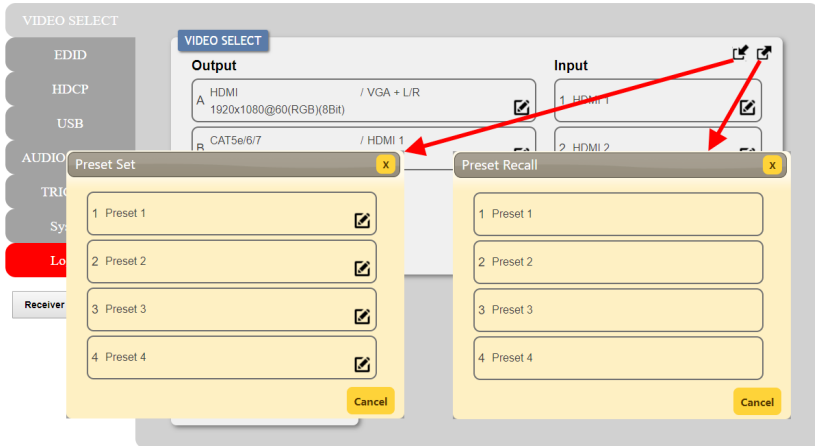

This unit can store up to four routing presets. Presets can be utilised to store multiple different routing states in advance for rapid, hassle-free, recall.

- 3) **Preset Set:** Once you have the routing set the way you like, you can click the "Preset Set" icon (📌) in the upper right corner of the tab to open the Preset Set window. Click on the preferred Preset button when you are ready to commit the preset to memory. You may also rename the preset at this stage by selecting the "edit" icon (✎).
- 4) **Preset Recall:** When you wish to load a previously stored preset, please click the "Preset Recall" icon (📌) and you will be presented with a choice of the available 4 presets. The preset will load immediately upon selecting the button.

6.5.2 EDID Tab

This tab provides the option of six standard EDIDs, two sink sourced EDIDs and four customer uploaded User EDIDs that can be assigned to any or all of the HDMI/DisplayPort input ports.

VIDEO SELECT

EDID

HDCP

USB

AUDIO SELECT

TRIGGER

System

Logout

Receiver Webpage

EDID

Customer EDID Settings

1	<input type="text" value="User 1"/>	<input type="button" value="Save Name"/>	<input type="button" value="Download"/>	<input type="button" value="Upload"/>
2	<input type="text" value="User 2"/>	<input type="button" value="Save Name"/>	<input type="button" value="Download"/>	<input type="button" value="Upload"/>
3	<input type="text" value="User 3"/>	<input type="button" value="Save Name"/>	<input type="button" value="Download"/>	<input type="button" value="Upload"/>
4	<input type="text" value="User 4"/>	<input type="button" value="Save Name"/>	<input type="button" value="Download"/>	<input type="button" value="Upload"/>

Sink EDID Download

Select

Set EDID Input Content

1	HDMI 1 FHD 2CH
2	HDMI 2 UHD+ MCH
3	DP UHD+ MCH

EDID Source

1	Internal 1 FHD 2CH
2	Internal 2 FHD MCH
3	Internal 3 UHD 2CH
4	Internal 4 UHD MCH
5	Internal 5 UHD+ 2CH
6	Internal 6 UHD+ MCH
7	User 1 User 1
8	User 2 User 2
9	User 3 User 3
10	User 4 User 4
11	Sink HDMI Sink A
12	Sink CAT5e/6/7 Sink B

18

1) Customer EDID Settings:

- **Save Name:** To modify the name of a User EDID, simply type the new name in the space provided and then click on the “Save Name” button to confirm the change.
- **Upload:** To upload a User EDID, press the “Upload” button next to the User EDID slot you wish to upload into. An EDID Upload window will appear, allowing you to locate and upload the preferred EDID file (*.bin format) from a local PC. Once the correct file has been selected, please click the “Upload” button in the window, and the file will be transferred to the unit.
- **Download:** To save an existing User EDID to your local PC, press the “Download” button next to the User EDID slot you wish to save. Depending on your browser settings you will either be asked where to save the downloaded file, or the file will be transferred to the default download location on your PC.

2) **Sink EDID Download:** To save the EDID from a connected display to your local PC, select the sink from the dropdown list then press the “Download” button. Depending on your browser settings you will either be asked where to save the downloaded file, or the file will be transferred to the default download location on your PC.

3) **Set EDID Input Content/EDID Source:** The Set EDID Input Content section allows for the assignment of a specific EDID to any supported Input port. Click on one or more input buttons on the left and then select the new EDID source to use from the choices on the right. The buttons will change colour as you select them and the EDID change will occur immediately across all selected Inputs.

Note: In most cases, assigning a new EDID to an input will cause the affected input to briefly blink out while the source adapts to the new information.

This unit provides the following 6 default EDIDs:

Unit's Default EDIDs		
FHD/2CH	1920×1080p@60Hz (148MHz) & 8-bit colour	LPCM 2.0
FHD/MCH	1920×1080p@60Hz (148MHz) & 8-bit colour	LPCM 7.1 & Bitstream
UHD/2CH	3840×2160p@30Hz (297MHz) & Deep Colour (8/10/12-bit)	LPCM 2.0
UHD/MCH	3840×2160p@30Hz (297MHz) & Deep Colour (8/10/12-bit)	LPCM 7.1 & Bitstream
UHD+/2CH	3840×2160p@60Hz (594MHz) & Deep Colour (8/10/12-bit)	LPCM 2.0
UHD+/MCH	3840×2160p@60Hz (594MHz) & Deep Colour (8/10/12-bit)	LPCM 7.1 & Bitstream

Note: In some rare cases it is possible for custom or external EDIDs to cause compatibility issues with certain sources. If this happens, it is recommended to switch to one of the 6 default EDIDs for maximum compatibility.

6.5.3 HDCP Tab

This tab provides the option of three HDCP operational modes that can be assigned to any or all of the HDMI/DisplayPort input ports.

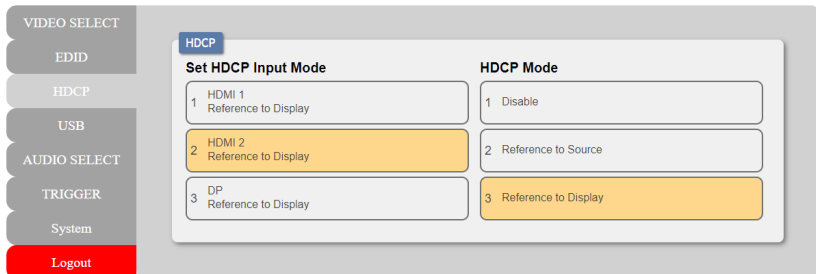

1) Set HDCP Input Mode/HDCP Mode: The HDCP Input Mode section allows for the assignment of a specific HDCP behavior to any

supported input port. Click on one or more input buttons on the left and then select the new HDCP mode to use from the choices on the right. The buttons will change colour as you select them and the change in HDCP behavior will occur immediately across all selected inputs. "Reference to Source" will make the input operate using the HDCP version required by the connected source. "Reference to Display" will limit the input to only accept the HDCP version supported by the connected display. Selecting "Disable" will completely disable HDCP support on that input.

6.5.4 USB Tab

This tab provides a way to select which USB Host Port (USB Type B) is currently active.

Note: Changing the USB host will force the HDBaseT connection to briefly disconnect while it reconfigures. The connected host (PC, Laptop, etc.) may also take a moment to detect all available devices.

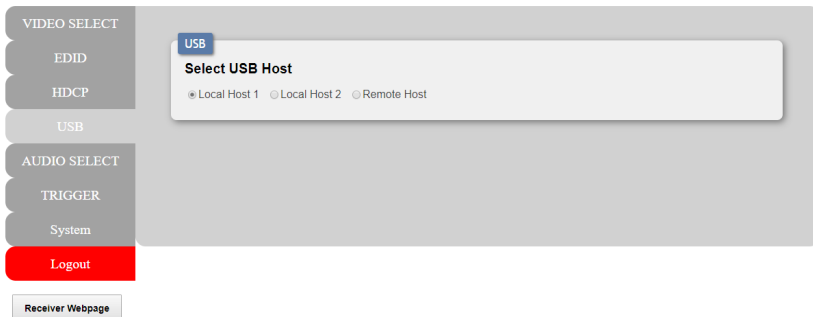

- 1) Set USB Mode:** Select the preferred USB Host Port, from the displayed selection, to use as the currently active connection. The change will occur immediately and all USB Device Ports (USB Type A) on the Transmitter and Receiver will connect to the new host.

Note: When "Remote Host" is selected, the Host Port on the Receiver will become active.

6.5.5 Audio Select Tab

This tab provides control over which audio is routed to the HDBaseT/ Analogue audio outputs as well as control over audio mixing, analogue I/ O volume and the microphone's phantom power voltage.

Note: HDMI audio output is always a direct pass-through from the selected source and is not affected by the controls on this tab.

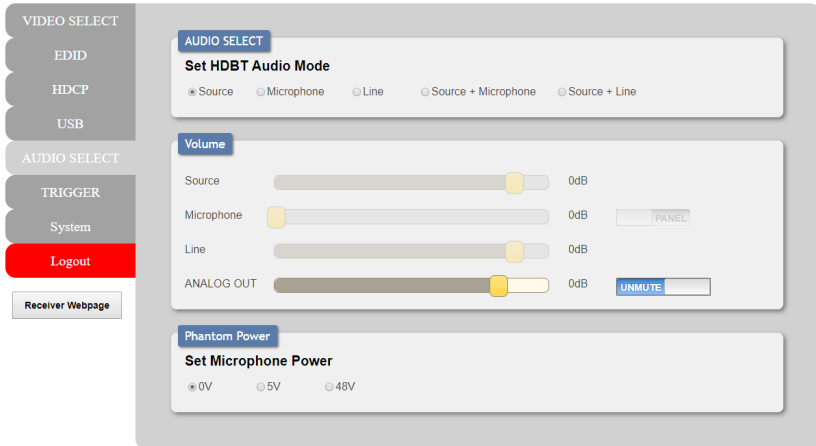

1) **Audio Select:** The audio routed to the HDBaseT/Analogue Audio outputs is selected in this section. All changes are enacted immediately.

- **Set HDBT Audio Mode:** Select the preferred audio content to route to the HDBaseT/Analogue Audio outputs. When “Source” is selected, the mixer is disabled and audio from the currently selected input will be passed through without modification, including bitstream sources. Selecting “Source+Microphone” or “Source+Line” will activate the mixer and combine the 2 audio sources together.

Note: When the mixer is active, only LPCM 2.0 audio is supported from the HDMI or DisplayPort inputs. Bitstream audio will be automatically muted.

2) **Volume:** This section provides controls for adjusting the volume levels of the microphone input, the various audio sources when the mixer is enabled, as well as providing control over the analogue audio output.

Note: Source and Line volume controls are only enabled when the two sources are being mixed.

- **Source:** Allows the adjustment of the currently selected video source's audio volume when the mixer is active. The available adjustment range is -120 to +18 dB.

Note: Only LPCM 2.0 is supported when the mixer is enabled. Bitstream audio will be automatically muted.

- **Microphone:** Allows the adjustment of the microphone input's volume level when the microphone is an active audio source (mixed or unmixed) and the toggle switch is set to "WEB". The available adjustment range is 0 to +60dB.
- **Web/Panel Toggle:** This toggle switch controls if the microphone volume is controlled by the WebGUI (select "WEB") or by the volume knob on the front of the unit (select "PANEL").

Note: If the microphone is not selected as a source, this toggle will be greyed out.

- **Line:** Allows the adjustment of the line audio volume when the mixer is active. The available adjustment range is -120 to +18 dB.
 - **Analogue Out:** Allows the adjustment of the balanced analogue output's volume level. The available adjustment range is -103 to +24 dB. The analogue output may also be muted or unmuted using the toggle switch.
- 3) **Phantom Power:** Select the phantom power voltage level for the microphone port. Selecting 0V disables phantom power. After selecting a new voltage level, the WebGUI requires confirmation of the change before the new voltage will be used.

6.5.6 Trigger Tab

This tab allows user to define the action taken set the definition of each Trigger pin. Click to check the drop down menu to select the config trigger define.

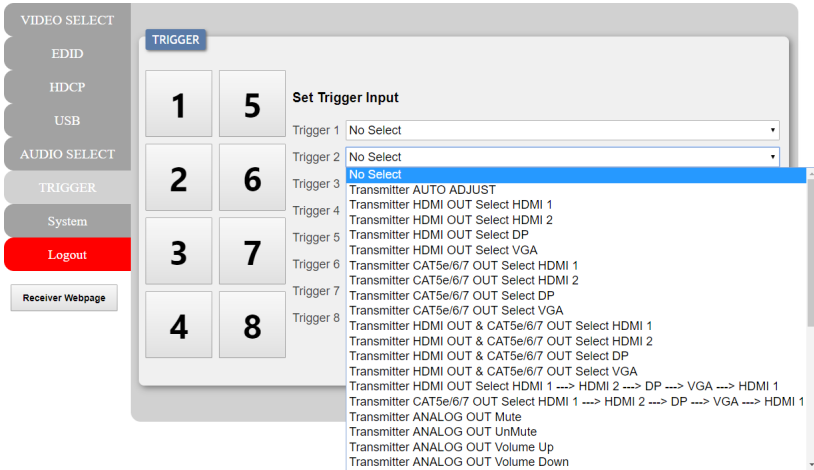

- 1) **Set Trigger Input:** Click on the dropdown next to each trigger number to assign a unit function or behavior to that trigger. If the selected function indicates a progression, then each activation of the trigger will move sequentially to the next item in the progression list.
- 2) **Trigger Test Keypad:** Click on any of the large numbered buttons on the left side of the tab to test the assigned function for each trigger.

6.5.7 System Tab

This tab provides system information, network configuration options, system configuration resets, and firmware update functions.

The screenshot shows the 'System' configuration page. On the left, a sidebar lists various settings categories, with 'System' selected and highlighted in red. Below it are 'Logout' and 'Receiver Webpage' buttons. The main content area is titled 'System' and contains several sections:

- Web User Setting:** Fields for Username, Password, New Username, Confirm Username, New Password, and Confirm Password, with a 'Save' button.
- NetWork:** Fields for IP (192.168.1.50), Netmask (255.255.255.0), Gateway (192.168.1.254), and MAC Address. It also includes IP Mode (STATIC-IP), Static IP (192.168.1.50), Static Netmask (255.255.255.0), and Static Gateway (192.168.1.254) fields, with a 'Save' button.
- Reset to Default:** Buttons for 'Routing Reset' and 'Factory Default'.
- Web Login Timeout (Minute, 0 is no timeout):** A field set to 0 and a 'Save' button.
- Firmware Upgrade:** A 'Choose File' button (No file chosen) and an 'Upgrade' button.

1) System:

- **Web User Setting:** This section provides a way to change the password for the Administrator account. Click on “Save” to confirm and activate any changes made to these settings.

Note: The default username and password is “admin”.

- **Network:** The unit’s IP mode may be switched between Static IP or DHCP. In Static IP mode the IP, netmask and gateway addresses may be manually set. When in DHCP mode, the unit will attempt to connect to a local DHCP server and obtain IP, netmask and gateway addresses automatically. Please press “Save” after making any changes to the IP configuration or mode.

Note: If the IP address is changed then the IP address required for WebGUI/Telnet access will also change accordingly.

- **Reset to Default:** Press the “Routing Reset” button to reset all I/O routing configurations to the factory defaults. Press the “Factory Reset” button to reset the unit to its factory default state. After the factory reset is complete, the unit will reboot automatically.

- **Web Login Timeout:** Select the length of time to wait before logging the user out of the WebGUI due to inactivity. Available range is from 1 to 65535 minutes. Setting this to 0 will disable the inactivity timeout.
- **Firmware Upgrade:** To update the unit's firmware, click the "Choose File" button to open the file selection window and then select the firmware update file (*.bin format) located on your local PC. After selecting the file, click the "Upgrade" button to begin the firmware update process. After the upgrade is complete, the unit will reboot automatically.

6.6 Telnet Control

Before attempting to use Telnet control, please ensure that both the unit and the PC are connected to the same active networks.

To Access the Command Line Interface (CLI)	
Windows 7	Click Start , type "cmd" in the search field, and press Enter .
Windows XP	Click Start > Run , type "cmd", and press Enter .
Mac OS X	Click Go > Applications > Utilities > Terminal .

Once in the Command Line Interface (CLI) type "**telnet**" followed by the IP address of the unit (and the port number if it is non-standard) and then hit "**Enter**". This will connect us to the unit we wish to control.

```
Microsoft Windows [Version 6.1.7601]
Copyright (c) 2009 Microsoft Corporation. All rights reserved.

C:\Users\Administrator>telnet 192.168.1.50 23
```

Note 1: If the IP address is changed then the IP address required for Telnet access will also change accordingly.

Note 2: The default IP address is 192.168.1.50.

6.7 RS-232 and Telnet Commands

COMMAND	
Description and Parameters	
help ↵	Show the full command list.
? ↵	Show the full command list.
help N1 ↵	Show help details about command N1 . N1 = {Command}
get model name ↵	Show the unit's model name.
get fw ver ↵	Show the unit's current firmware version.
set factory default ↵	Reset all settings to the factory defaults.
set factory ipconfig default ↵	Reset the IP configuration to the factory defaults.
set factory out route default ↵	Reset output routing to the factory defaults.
set system reboot ↵	Reboot the unit.
set ip mode N1 ↵	Set the IP address assignment mode. Available values for N1 : 0 [Static IP Mode] 1 [DHCP Mode]

COMMAND	
Description and Parameters	
get ip mode ↵	
	Show the current IP address assignment mode.
get ipconfig ↵	
	Show the unit's current IP configuration information.
set ip addr N1 ↵	
	Set the unit's static IP address. N1 = X.X.X.X [X = 0 ~ 255]
get ip addr ↵	
	Show the unit's current IP address.
set netmask ↵	
	Set the unit's static netmask. N1 = X.X.X.X [X = 0 ~ 255]
get netmask ↵	
	Show the unit's current netmask.
set gateway N1 ↵	
	Set the unit's static gateway address. N1 = X.X.X.X [X = 0 ~ 255]
get gateway ↵	
	Show the unit's current gateway address.
set webgui username N1 ↵	
	Set the WebGUI administrator user name. N1 = {Name} [16 characters max]
get webgui username ↵	
	Show the current WebGUI administrator user name.
set webgui password N1 ↵	
	Set WebGUI administrator password. N1 = {Password} [16 characters max]

COMMAND	
Description and Parameters	
get webgui password ↵	
	Show the current WebGUI administrator password.
set webgui login timeout N1 ↵	
	Set the WebGUI inactivity timeout value. Available values for N1 : 0 [No timeout] 1 ~ 65535 [Timeout in minutes]
get webgui login timeout ↵	
	Show the current WebGUI inactivity timeout value.
set in N1 name N2 ↵	
	Set the name of the specified input. N1 = 1~4 [Input port] N2 = {Name} [16 characters max]
get in N1 name ↵	
	Show the current name of the specified input. N1 = 1~4 [Input port]
set out N1 name N2 ↵	
	Set the name of the specified output. N1 = A ~ B [Output port] N2 = {Name} [16 characters max]
get out N1 name ↵	
	Show the name of the specified output. N1 = A ~ B [Output port]
set out N1 route N2 ↵	
	Set the routing of the specified output. N1 = A ~ B [Output port] N2 = 1~4 [Input port]

COMMAND	
Description and Parameters	
get out N1 route ↵	
<p>Show the routing for the specified output.</p> <p>N1 = A ~ B [Output port]</p>	
get in name list ↵	
<p>List all input names.</p>	
get out name list ↵	
<p>List all output names.</p>	
set out N1 auto mode N2 ↵	
<p>Set the automatic switching behavior of the specified output.</p> <p>N1 = A ~ B [Output port]</p> <p>Available values for N2:</p> <p>0 [Off]</p> <p>1 ~ 65535 [Auto switch]</p>	
get out N1 auto mode ↵	
<p>Show the currently selected automatic switching behavior of the specified output.</p> <p>N1 = A ~ B [Output port]</p>	
get in N1 hactive ↵	
<p>Show the detected horizontal active pixel total for input N1's signal.</p> <p>N1 = 1~4 [Input port]</p>	
get in N1 vactive ↵	
<p>Show the detected vertical active pixel total for input N1's signal.</p> <p>N1 = 1~4 [Input port]</p>	
get in N1 refresh rate ↵	
<p>Show the detected refresh rate for input N1's signal.</p> <p>N1 = 1~4 [Input port]</p>	

COMMAND	
Description and Parameters	
get in N1 interlace ↵	
Show if the source connected to input N1 is interlaced or not.	
N1 = 1~4	[Input port]
Possible response values:	
0	[Progressive]
1	[Interlaced]
get in N1 sync status ↵	
Show the detected sync state for input N1.	
N1 = 1~4	[Input port]
Possible response values:	
0	[No sync]
1	[Sync active]
get in N1 timing ↵	
Show the resolution and timing index value for input N1's signal.	
N1 = 1~4	[Input port]
get in N1 deep color ↵	
Show the detected colour bit depth for input N1's signal.	
N1 = 1~4	[Input port]
get in type list ↵	
List the signal format of all inputs.	
get out type list ↵	
List the signal format of all outputs.	
set out route N1N2,N1N2 ↵	
Set unique input routing for both outputs simultaneously.	
N1 = A ~ B	[Output port]
N2 = 1~4	[Input port]

COMMAND	
Description and Parameters	
set all out route N1 ↵	
Set the routing for all outputs to a single input. N1 = 1~4 [Input port]	
get all out route ↵	
List the current input routing for all outputs.	
set out N1 cec data N2 ↵	
Send a CEC command, as hex data, to the display connected to the specified output. N1 = A ~ B [Output port] N2 = {CEC data} [Comma delimited hex pairs]	
get out N1 cec capability ↵	
Show if the display connected to the specified output supports CEC. N1 = A ~ B [Output port]	
set keylock N1 ↵	
Enable or disable the front panel key lock. Available values for N1: ON [Locked] OFF [Unlocked]	
get keylock ↵	
Show the current front panel key lock state.	
set current route to preset N1 ↵	
Save all current routing assignments to the specified preset. N1 = 1~4 [Preset number]	
set route preset N1 ↵	
Activate the routing assignments saved in the specified preset. N1 = 1~4 [Preset number]	

COMMAND	
Description and Parameters	
get preset N1 list ←	
Show the current routing saved within preset N1.	
N1 = 1~4	[Preset number]
set route preset N1 name N2 ←	
Set the name of preset N1.	
N1 = 1 ~ 4	[Preset number]
N2 = {Name}	[16 characters max]
get route preset N1 name ←	
Show preset N1's current name.	
N1 = 1~4	[Preset number]
get in port number ←	
Show the total number of input ports.	
get out port number ←	
Show the total number of output ports.	
get out N1 sync status ←	
Show the current link status of output N1.	
N1 = A ~ B	[Output port]
set cat5e/6/7 audio mode N1 ←	
Select the preferred audio content to route to the HDBaseT/ Analogue Audio outputs.	
Available values for N1 :	
1	[Source audio only]
2	[Line audio only]
3	[Microphone only]
4	[Source+Microphone]
5	[Source+Line]

COMMAND
Description and Parameters
get cat5e/6/7 audio mode ↵
Show the current audio content to routed to the HDBaseT/Analogue Audio outputs.
set microphone mode N1 ↵
Set the location to use for manual control of the microphone volume. Available values for N1 : 0 [Front panel] 1 [WebGUI]
get microphone mode ↵
Show the location currently allowing manual control of the microphone volume.
set audio mixer source volume N1 ↵
Set the mixer source volume. N1 = -120 ~ +18 [Volume in dB]
get audio mixer source volume ↵
Show the current mixer source volume.
set microphone volume N1 ↵
Set the microphone volume. N1 = -0 ~ +60 [Volume in dB]
get microphone volume ↵
Show the current microphone volume.
set audio mixer line volume N1 ↵
Set mixer line volume. N1 = -120 ~ +18 [Volume in dB]
get audio mixer line volume ↵
Show the mixer line volume.

COMMAND	
Description and Parameters	
set analog output volume N1 ↵	
Set the analogue output volume. N1 = -103 ~ +24 [Volume in dB]	
get analog output volume ↵	
Show the current analogue output volume.	
set analog output mute N1 ↵	
Enable or disable muting the analogue audio output. Available values for N1 : ON [Mute] OFF [Unmute]	
get analog output mute ↵	
Show the current mute state of the analogue audio output.	
set phantom mode N1 ↵	
Set the microphone's phantom power voltage level. Available values for N1 : 0 [Off] 1 [5 Volt] 2 [48 Volt]	
get phantom mode ↵	
Show the current microphone phantom power voltage setting.	

COMMAND	
Description and Parameters	
set in N1 edid N2 ↵	
Set the EDID to use on the specified input. (HDMI and DisplayPort only)	
N1 = 1 ~ 3	[Input port]
Available values for N2:	
1	[FHD 2CH]
2	[FHD MCH]
3	[UHD 2CH]
4	[UHD MCH]
5	[UHD+ 2CH]
6	[UHD+ MCH]
7	[User 1]
8	[User 2]
9	[User 3]
10	[User 4]
11	[Sink A]
12	[Sink B]
get in N1 edid ↵	
Show the EDID currently being used on the specified input. (HDMI and DisplayPort only)	
N1 = 1 ~ 3	[Input port]
get in edid list ↵	
List all available EDID selections.	
set edid N1 name N2 ↵	
Set the name for the specified EDID. (Only User EDIDs may be renamed)	
N1 = 7 ~ 10	[User EDIDs]
N2 = {Name}	[16 characters max]

COMMAND	
Description and Parameters	
get edid N1 name ↵	
<p>Show the name for the specified EDID. (User EDIDs only)</p> <p>N1 = 7 ~ 10 [User EDIDs]</p>	
set user N1 edid data N2 ↵	
<p>Upload a new EDID (in HEX format) for use as the specified User EDID.</p> <p>N1 = 7 ~ 10 [User EDIDs] N2 = {EDID data} [Comma delimited hex pairs]</p>	
get user N1 edid data ↵	
<p>Show the current contents of the specified User EDID as HEX data.</p> <p>N1 = 7 ~ 10 [User EDIDs]</p>	
get sink N1 edid data ↵	
<p>Show the EDID from the display connected to the specified output as HEX data.</p> <p>N1 = A ~ B [Output port]</p>	
get in N1 edid data ↵	
<p>Show the EDID currently used by the specified input as HEX data. (HDMI and DisplayPort only)</p> <p>N1 = 1 ~ 3 [Input port]</p>	
get all in edid list ↵	
<p>List the EDIDs assigned to all inputs.</p>	
get internal N1 edid data ↵	
<p>Show the specified Internal EDID as HEX data.</p> <p>N1 = 1 ~ 6 [Internal EDIDs]</p>	

COMMAND	
Description and Parameters	
set in N1 hdcp mode N2 ↵	
Set the HDCP behavior of the specified input. (HDMI and DisplayPort only)	
N1 = 1 ~ 3	[Input port]
Available values for N2:	
0	[Support disabled]
1	[Follow source]
2	[Follow display]
get in N1 hdcp mode ↵	
Show the current HDCP behavior used by the specified input. (HDMI and DisplayPort only)	
N1 = 1 ~ 3	[Input port]
get in N1 hdcp status ↵	
Show the current HDCP status of the specified input. (HDMI and DisplayPort only)	
N1 = 1 ~ 3	[Input port]
Possible response values:	
0	[No HDCP]
1	[HDCP 1.x]
2	[HDCP 2.2]
get out N1 hdcp status ↵	
Show the current HDCP status of the specified output.	
N1 = A ~ B	[Output port]
Possible response values:	
0	[No HDCP]
1	[HDCP 1.x active]
2	[HDCP 2.2 active]
3	[HDCP 1.x failed]
4	[HDCP 2.x2 failed]

COMMAND	
Description and Parameters	
get out N1 hdcp ability ↵	
Show the HDCP compliance level of the display device connected to the specified output. N1 = A ~ B [Output port] Possible response values: 0 [No HDCP] 1 [HDCP 1.x] 2 [HDCP 2.2] 3 [HDCP 1.x+2.2]	
get in N1 hdcp ability ↵	
Show the HDCP compliance level of the source connected to the specified input. N1 = 1 ~ 4 [Input port] Possible response values: 0 [No HDCP] 1 [HDCP 1.x] 2 [HDCP 2.2] 3 [HDCP 1.x+2.2]	

Note: Commands will not be executed unless followed by a carriage return. Commands are not case-sensitive.

7. CONNECTION DIAGRAM

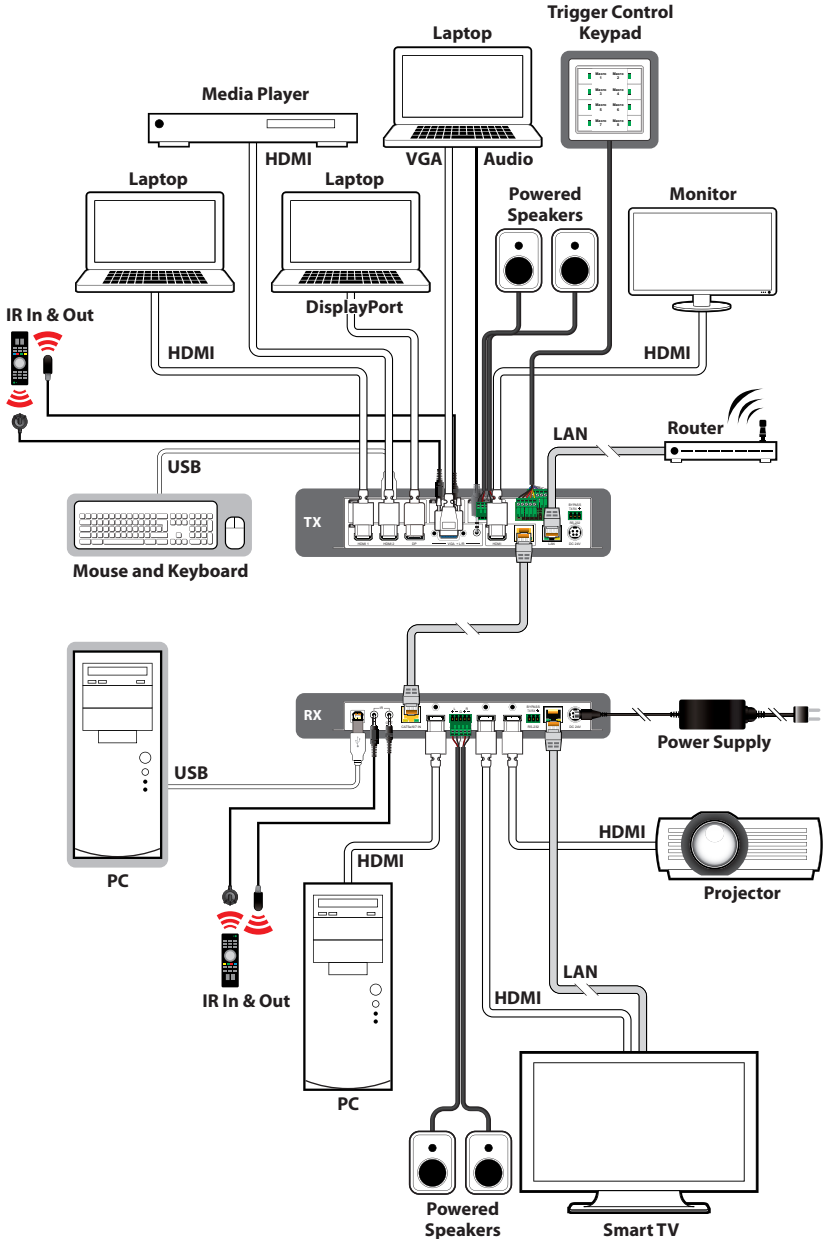

8. SPECIFICATIONS

8.1 Technical Specifications

HDMI Bandwidth	18Gbps
DisplayPort Bandwidth	21.6Gbps
VGA Bandwidth	165MHz
HDBaseT Bandwidth	10.2Gbps
Input Ports	2×HDMI (Type-A) 1×DisplayPort 1×VGA (HD-15) 2×Unbalanced Stereo (3.5mm) 1×Microphone (6.35mm)
Output Ports	1×HDBaseT (RJ-45) 1×HDMI (Type-A) 1×Balanced Stereo (5-pin Term. Block)
Pass-through Ports	1×IR Extender (3.5mm) 1×IR Blaster (3.5mm) 2×USB 2.0 (Type A) 2×USB 2.0 (Type B) 1×RS-232 (3-pin Terminal Block)
Pass-through/Service Port	1×USB 2.0 (Type A)
Pass-through/Control Port	1×LAN (RJ-45)
Control Ports	1×RS-232 (3.5mm) 1×Trigger (10-pin Terminal Block)
IR Frequency	30 – 50kHz (30 – 60kHz under ideal conditions)
Baud Rate (Control)	19200 (Default)
Baud Rate (Bypass)	Up to 115200

Power Supply	24V/3.75A DC (US/EU standards, CE/FCC/UL certified)
ESD Protection (HBM)	±8kV (Air Discharge) ±4kV (Contact Discharge)
Dimensions (W×H×D)	231.5mm×44mm×167mm [Case Only] 231.5mm×44mm×174mm [All Inclusive]
Weight	1204g
Chassis Material	Metal (Steel)
Chassis Colour	Black
Operating Temperature	0°C – 40°C/32°F – 104°F
Storage Temperature	–20°C – 60°C/–4°F – 140°F
Relative Humidity	20 – 90% RH (Non-condensing)
Power Consumption	23.54W

8.2 Video Specifications

Supported Resolutions (Hz)	Input			Output	
	HDMI	DP	VGA	HDMI	HDBT
720x400p@70/85	✓	✓	✓	✓	✓
640x480p@60/72/75/85	✓	✓	✓	✓	✓
720x480i@60	✓	✓	✓	✓	✓
720x480p@60	✓	✓	✓	✓	✓
720x576i@50	✓	✓	✓	✓	✓
720x576p@50	✓	✓	✓	✓	✓
800x600p@56/60/72/75/85	✓	✓	✓	✓	✓
848x480p@60	x	x	x	x	x
1024x768p@60/70/75/85	✓	✓	✓	✓	✓
1152x864p@75	✓	✓	✓	✓	✓
1280x720p@50/60	✓	✓	✓	✓	✓
1280x768p@60/75/85	✓	✓	✓	✓	✓
1280x800p@60/75/85	✓	✓	✓	✓	✓
1280x960p@60/85	✓	✓	✓	✓	✓
1280x1024p@60/75/85	✓	✓	✓	✓	✓
1360x768p@60	✓	✓	✓	✓	✓
1366x768p@60	✓	✓	✓	✓	✓
1400x1050p@60	✓	✓	✓	✓	✓
1440x900p@60/75	✓	✓	✓	✓	✓
1600x900p@60RB	✓	✓	✓	✓	✓
1600x1200p@60	✓	✓	✓	✓	✓
1680x1050p@60	✓	✓	✓	✓	✓
1920x1080i@50/60	✓	✓	✓	✓	✓
1920x1080p@24/25/30	✓	✓	✓	✓	✓

Supported Resolutions (Hz)	Input			Output	
	HDMI	DP	VGA	HDMI	HDBT
1920×1080p@50/60	✓	✓	✓	✓	✓
1920×1200p@60RB	✓	✓	✓	✓	✓
2560×1440p@60RB	✓	✓	✗	✓	✓
2560×1600p@60RB	✓	✓	✗	✓	✓
2048×1080p@24/25/30	✓	✓	✗	✓	✓
2048×1080p@50/60	✓	✓	✗	✓	✓
3840×2160p@24/25/30	✓	✓	✗	✓	✓
3840×2160p@50/60 (4:2:0)	✓	✓	✗	✓	✓
3840×2160p@24, HDR10	✓	✓	✗	✓	✗
3840×2160p@50/60 (4:2:0), HDR10	✓	✓	✗	✓	✗
3840×2160p@50/60	✓	✓	✗	✓	✗
4096×2160p@24/25/30	✓	✓	✗	✓	✓
4096×2160p@50/60 (4:2:0)	✓	✓	✗	✓	✓
4096×2160p@24, HDR10	✓	✓	✗	✓	✗
4096×2160p@50/60 (4:2:0), HDR10	✓	✓	✗	✓	✗
4096×2160p@50/60	✓	✓	✗	✓	✗

8.3 Audio Specifications

8.3.1 Digital Audio

HDMI & DisplayPort Input	
LPCM	
Max Channels	8 Channels
Sampling Rate (kHz)	32, 44.1, 48, 88.2, 96, 176.4, 192
Bitstream	
Supported Formats	Standard & High-Definition

HDBaseT & HDMI Output	
LPCM	
Max Channels	8 Channels
Sampling Rate (kHz)	32, 44.1, 48, 88.2, 96, 176.4, 192
Bitstream	
Supported Formats	Standard & High-Definition

8.3.2 Analogue Audio

Analogue Input (Stereo)	
Max Audio Level	1Vrms
Impedance	10k Ω
Type	Unbalanced

Analogue Input (Microphone)	
Max Audio Level	2.1Vrms
Impedance	47k Ω
Type	Balanced or Unbalanced

Analogue Output	
Max Audio Level	1Vrms
THD+N	< -80dB@0dBFS 1kHz (A-wt)
SNR	> 80dB@0dBFS
Frequency Response	< ±1dB@20Hz~20kHz
Crosstalk	< -80dB@10kHz
Impedance	470Ω
Type	Balanced

8.4 Cable Specifications

Cable Length	1080p		4K30	4K60
	8-bit	12-bit	(4:4:4) 8-bit	(4:4:4) 8-bit
High Speed HDMI Cable				
HDMI Input	15m	10m	5m	3m
HDMI Output	15m	10m	5m	3m
DisplayPort Cable				
DisplayPort Input	15m	10m	2m	2m
Ethernet Cable				
Cat.5e/6	100m		90m	
Cat.6a/7	100m		100m	
VGA Cable				
VGA Input	1.5m	1.5m	x	

Bandwidth Category Examples:

1080p (FHD Video)

- Up to 1080p@60Hz, 12-bit colour
- Data rates lower than 5.3Gbps or below 225MHz TMDS clock

4K30 (UHD Video)

- 4K@24/25/30Hz & 4K@50/60Hz (4:2:0), 8-bit colour
- Data rates higher than 5.3Gbps or above 225MHz TMDS clock but below 10.2Gbps

4K60 (UHD+ Video)

- 4K@50/60Hz (4:4:4, 8-bit)
- 4K@50/60Hz (4:2:0, 10-bit HDR)
- Data rates higher than 10.2Gbps

8.5 HDBaseT Features

HDBaseT Feature Set	Transmitter
Video & Audio	Supported
LAN Pass-through	Supported
Send power to Receiver	Unsupported
Accept power from Receiver	Supported
IR Pass-through	Supported
RS-232 Pass-through	Supported

9. ACRONYMS

ACRONYM	COMPLETE TERM
ADC	Analogue-to-Digital Converter
ASCII	American Standard Code for Information Interchange
AV	Audio/Video
Cat.5e	Enhanced Category 5 cable
Cat.6	Category 6 cable
Cat.6a	Augmented Category 6 cable
Cat.7	Category 7 cable
CLI	Command-Line Interface
DAC	Digital-to-Analogue Converter
DHCP	Dynamic Host Configuration Protocol
DP	DisplayPort
DVI	Digital Visual Interface
EDID	Extended Display Identification Data
GUI	Graphical User Interface
HD	High-Definition
HDBT	HDBaseT
HDCP	High-bandwidth Digital Content Protection
HDMI	High-Definition Multimedia Interface
HDR	High Dynamic Range
HDTV	High-Definition Television
IP	Internet Protocol
IR	Infrared
KVM	Keyboard/Video/Mouse
LAN	Local Area Network
LED	Light-Emitting Diode

ACRONYM	COMPLETE TERM
LPCM	Linear Pulse-Code Modulation
MAC	Media Access Control
PD	Powered Device
PoH	Power over HDBaseT
PSE	Power Sourcing Equipment
SNR	Signal-to-Noise Ratio
TCP	Transmission Control Protocol
THD+N	Total Harmonic Distortion plus Noise
UHD	Ultra-High-Definition
UHD+	Ultra-High-Definition Plus
UHDTV	Ultra-High-Definition Television
USB	Universal Serial Bus
VGA	Video Graphics Array
WUXGA (RB)	Widescreen Ultra Extended Graphics Array (Reduced Blanking)
XGA	Extended Graphics Array



CYP (UK) Ltd., Unit 7, Shepperton Business Park, Govett Avenue, Shepperton,
Middlesex, TW17 8BA

Tel: +44 (0) 20 3137 9180 | Fax: +44 (0) 20 3137 6279

Email: sales@cypeurope.com

www.cypeurope.com

v1.00