



# LS-110

---

## Media Station

User Manual | English

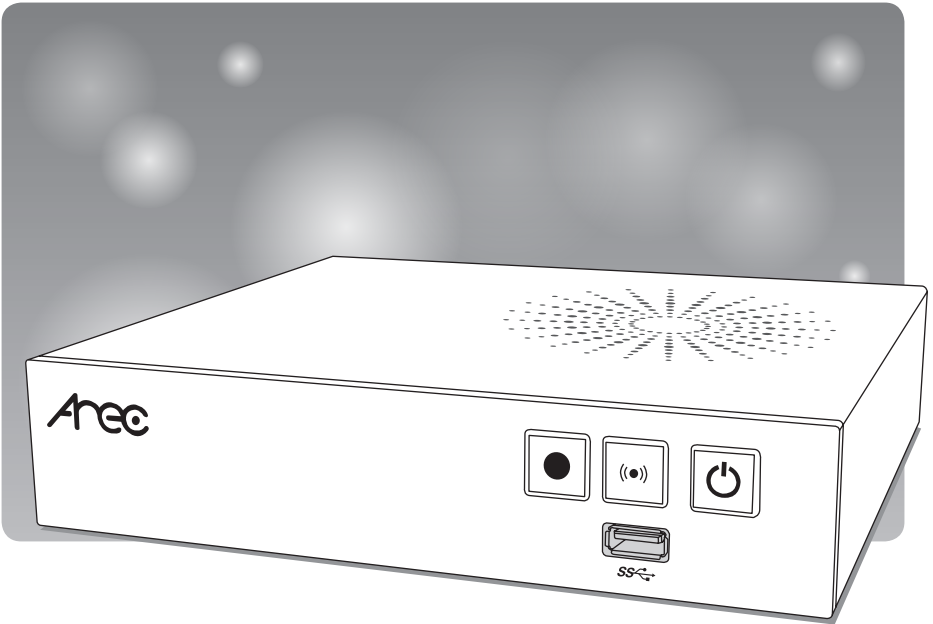

# Table of Contents

<b>Introduction</b> .....	4
<b>Specifications</b> .....	4
<b>Package Contents</b> .....	4
<b>Product Appearance</b> .....	5
<b>Connection</b> .....	6
<b>Front Panel Buttons and Indicators</b> .....	7
<b>External Control via USB Numeric Keypad</b> .....	7
<b>Getting start</b> .....	8
<b>Overview of the Web Interface</b> .....	8
<b>Chapter 1 Administrator</b> .....	9
1.1 Media I/O .....	9
1.1.1 Video inputs .....	10
1.1.1.1 Content / Cam 1 .....	10
1.1.1.2 Advanced configuration .....	11
1.1.2 Network device manager .....	12
1.1.3 PTZ control port .....	13
1.1.4 Audio .....	13
1.1.5 Display .....	14
1.2 Video .....	14
1.2.1 Recording .....	15
1.2.2 Streaming .....	16
1.2.3 Content .....	19
1.2.4 Theme .....	19
1.3 Storage .....	21
1.4 Scheduler .....	22
1.5 Upload .....	27
1.5.1 Upload settings .....	28
1.5.2 Transfer settings .....	29
1.6 System .....	30
1.6.1 System settings .....	31
1.6.2 Network .....	32
1.6.3 Firmware .....	33
1.6.4 Configuration .....	33
1.7 Account .....	34

# Table of Contents

<b>Chapter 2 Director</b> .....	35
2.1 Local Director .....	35
2.1.1 Preview .....	35
2.1.2 Toolbar .....	36
2.1.2.1 Theme and Display .....	36
2.1.2.2 Recording, Streaming control and Snapshot .....	37
2.1.2.3 Playback Video .....	38
2.1.2.4 Settings .....	40
2.1.2.5 Others .....	41
2.2 Online Director .....	42
2.2.1 Recording controls panel .....	43
2.2.1.1 Background .....	43
2.2.1.2 Layout .....	43
2.2.1.3 Overlay .....	43
2.2.1.4 Theme .....	44
2.2.1.5 Volume control .....	44
2.2.1.6 Recording/ Streaming control and Snapshot buttons .....	45
2.2.2 Visual Sources Monitoring .....	46
2.2.3 Subtitle Editor .....	47
2.2.4 Recording/Streaming setup .....	48
<b>Chapter 3 Video Manager</b> .....	49
3.1 Video Management .....	49
3.1.1 Upload the recording .....	50
3.1.2 Download the recording .....	50
3.1.3 Delete the recording .....	50
3.1.4 Playback the recording .....	51
3.1.5 Edit the recording information .....	51
3.1.6 Edit the bookmark information .....	52
3.2 Snapshot Management .....	52
3.2.1 Upload the photo .....	53
3.2.2 Download the photo .....	53
3.2.3 Delete the photo .....	53
3.2.4 Preview the photo .....	54
<b>Table of On Screen Display Icons</b> .....	55

## Introduction

Featuring a compact and stand-alone design, AREC LS-110 Media Station consists of diverse features and functionality, including multi-signals capturing, recording synchronously, codec, streaming online, live broadcasting, and web-based monitor page, providing complete presentation or lecture capture solution.

## Specifications

Product Name	Media Station
Model Name	LS-110
Dimension	200mm(L) x 178mm(W) x 43mm(H)
Weight	1.37kg
Power Requirement	12V/2A
Power Consumption (Max.)	24W (Max.)
Operating Temperature / Humidity	0°C ~ 40°C / 90%
Maximum normal load description	Supports two video inputs, including 1 video signal interface (HDMI input) and up to two IP Cam/stream signals. And output the transcoded video/audio to the HDMI port and the HDMI loop.

## Package Contents

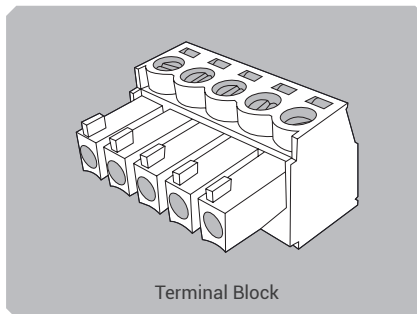
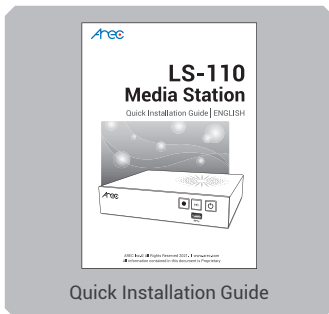
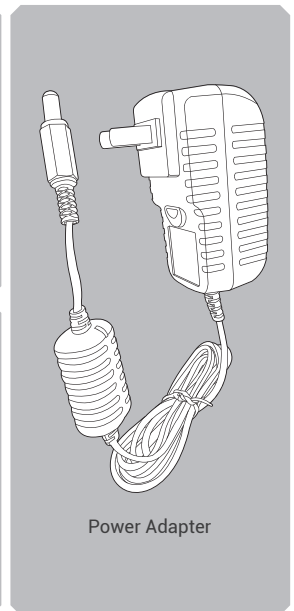
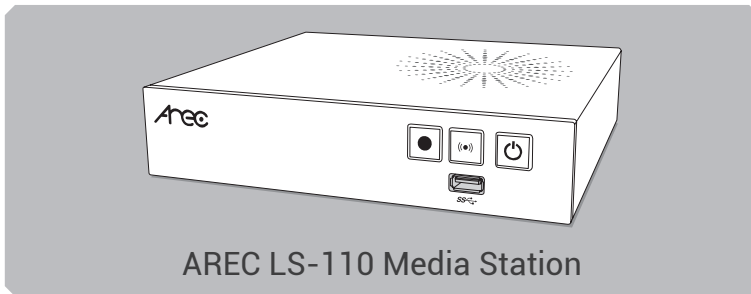

## Product Appearance

Front

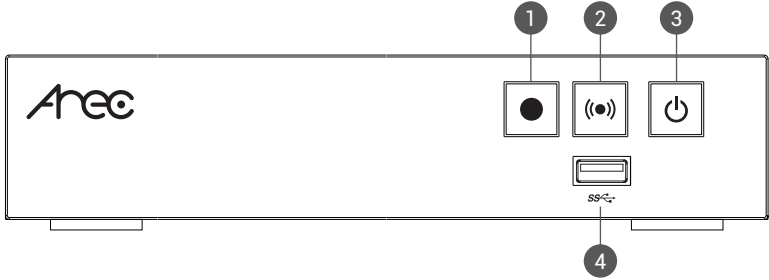

Back

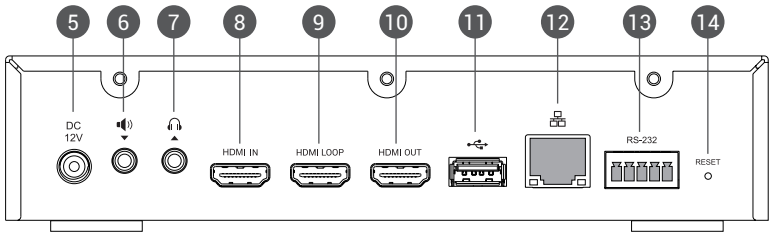



No.	Name	Brief introduction
1	Record function key	Control the Record and Stop function
2	Streaming function key	Turn live streaming on or off
3	Power	Power on/off the device
4	Front USB port	1. For external USB storage device* 2. Firmware update via USB disk 3. Available for USB mouse, keyboard 4. Available for USB audio input (Note: Connecting an USB audio device via an USB hub is not recommended. It may cause compatibility issues.)
5	Power port	12V / 2A
6	Audio input	Line audio input
7	Audio output	Line audio output
8	HDMI In(Video Input)	HDMI input source
9	HDMI Loop(Video Output)	HDMI loop through from input
10	HDMI Out(Video Output)	HDMI preview output
11	Back USB port	Available for external hard drive to increase storage
12	Network port	RJ-45 Ethernet connector for network connection
13	RS-232	Captive screw connector for control over RS-232
14	Reset button	Restoring devices to its factory default state

NOTE: The LS-110 can detect and record to USB storage devices using FAT32, NTFS file systems.

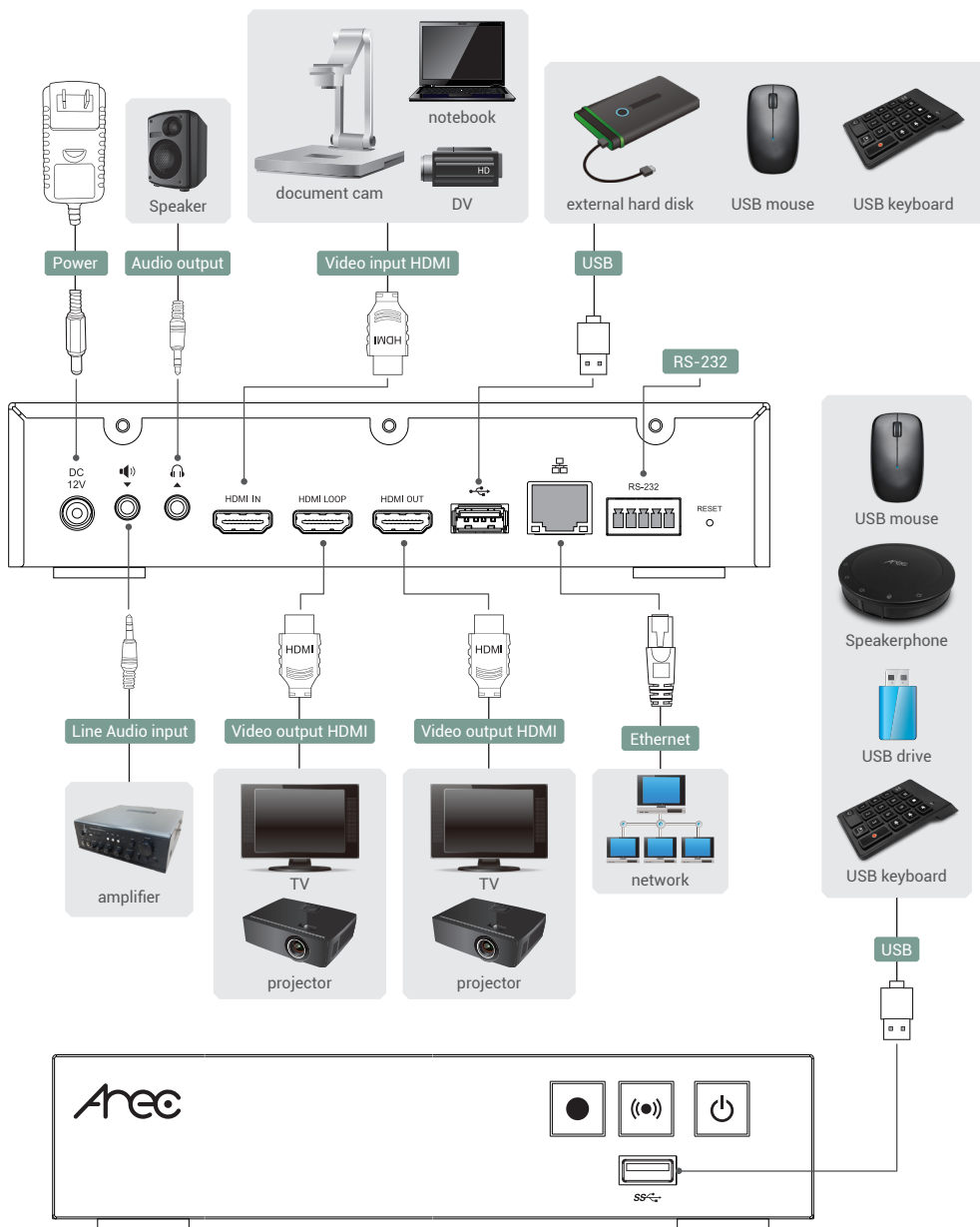
# Connection



## Front Panel Buttons and Indicators

Button	Display method of indicator	Product status
 Record (Stop)	Record button glows red continuously	Recording in progress
	Record button flashes red slowly	Recording is being finalized
 Stream (Stop)	Stream button glows red continuously	Streaming in progress
	Stream button flashes red slowly	Streaming is being finalized
 Power	Solid red	Device is powered, yet not booted up.
	Green and red light flash alternately	Device is booting up.
	Solid green	Boot up completed.
	Fast flashing red	Device is shutting down.
	Fast flashing green	Firmware updating.
	Slow flashing red	Embedded HDD error

## External Control via USB Keypad

Insert the keyboard into the Media Station's USB hole, let USB numeric keypad as function keys to control the Media Station.

Button	Brief introduction	Button	Brief introduction
1	Theme 1	Backspace	All input volume mute/unmute
2	Theme 2	-	All input volume down
3	Theme 3	+	All input volume up
4	Theme 4	Enter	Record
5	Theme 5	ESC	Power off
6	Theme 6	Z · z	Change Background
7	Theme 7	X · x	Change Layout
8	Theme 8	C · c	Change Overlay
9	Theme 9	V · v	Live streaming on/off
/	Pause	B · b	GUI Playback
*	Stop	A · a	All output volume up
0	Change Display	S · s	All output volume down
.	Snapshot	D · d	All output volume mute/unmute
Caps Lock	Record ON/OFF	G · g	GUI OFF/ON

## Getting start



Use the RJ-45 Ethernet cable to connect an IP-based network to the LAN port. Enter the IP address displayed in the lower right side of the screen in your browser to access the System Administration webpage.



Log in **Administrator**  with default username admin and password admin, then entering System Administration webpages.

## Overview of the Web Interface

LS-110 web interface has three user types, which are described in detail in the following chapters :

 Online Director	<p>For quick start recording, log in Online director from the initial login page with default username director and password director. This user also has access to Video Manager web pages. Log in with Administrator account, can switch to Administrator page.</p>
 Administrator	<p>To setup the device, log in Administrator with default username admin and password admin, then entering System Administrator webpages. The admin account provides the user all three type of privileges.</p>
 Video Manager	<p>If you only need to access to the recordings, log in Video Manager with default username video and password video. Log in with Administrator account, can switch to Administrator page.</p>



## Chapter 1 Administrator

The Administrator web pages provide a system administration interface of the LS-110: it can perform Media I/O, Video, Storage, Scheduler, Account, Upload, System and Account settings. The **Media I/O** settings make sure each input source are properly connected, and adjust the audio volume. The **Video** setting pages configure the recording, streaming, and other functions which define the content being recorded. **System** are pages contain basic settings and information of this device. Click  icon can switch to Video Manager page.

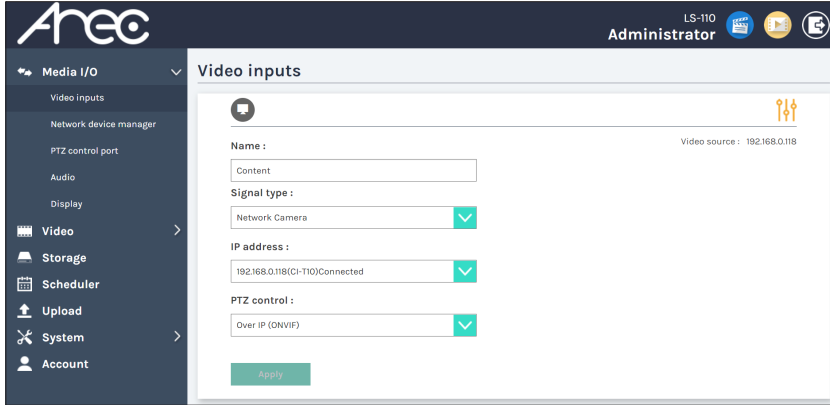

The screenshot shows the Arec Administrator interface. The left sidebar has 'Media I/O' selected, with 'Video inputs' highlighted. The main panel is titled 'Video inputs' and shows configuration for a video source. The 'Name' field contains 'Content'. The 'Signal type' is set to 'Network Camera'. The 'IP address' is '192.168.0.118(Connected)'. The 'PTZ control' is set to 'Over IP (ONVIF)'. A 'Video source' of '192.168.0.118' is shown in the top right. An 'Apply' button is at the bottom.

### 1.1 Media I/O

The pages within **Media I/O** include the following :

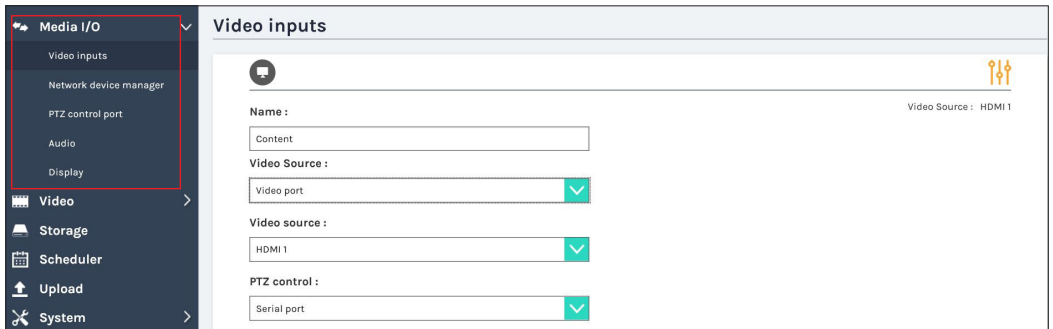

The screenshot shows the Arec Administrator interface with the 'Media I/O' menu expanded. The 'Video inputs' option is highlighted with a red box. The main panel is titled 'Video inputs' and shows configuration for an HDMI source. The 'Name' field contains 'Content'. The 'Video Source' is set to 'Video port'. The 'Video source' is 'HDMI 1'. The 'PTZ control' is set to 'Serial port'. A 'Video Source : HDMI 1' is shown in the top right.

Video inputs	Select the signal type, video source and PTZ control method for each input.
Network device manager	List out all the connected network cameras and Auto-Tracking Mount.
PTZ control port	Set LS-110 back USB-to-RS-232 serial port to drive PTZ cameras.
Audio	Adjust the volume and select the audio input source.
Display	Set the LS-110 on screen display language, video output settings and color adjustment.

### 1.1.1 Video inputs

The LS-110 is capable to process up to four video inputs. The name of these inputs are user configurable; by default are Content and Cam 1.

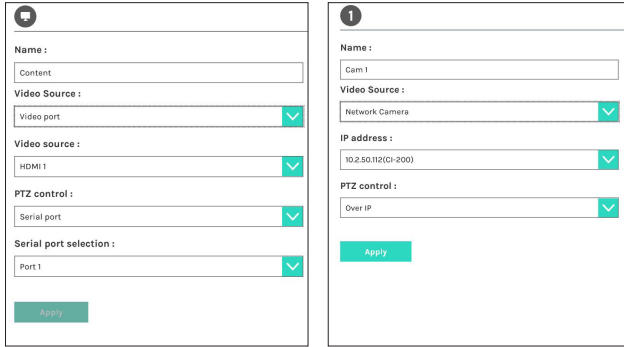

#### 1.1.1.1 Content / Cam 1

- **Video Source** can be chosen from [Network Camera](#), [Encoder](#) or [Video port](#). The last option is available only for the first two video inputs.

Video port	Select Video source: The LS-110 supports two video inputs, including 1 video signal interface (HDMI input) and up to two IP Cam/stream signals. And output the transcoded video/audio to the HDMI port and the HDMI loop.
Network Camera	Select IP address: Select from the camera ip address drop list of those available. Note: A login authentication with the camera might be required. See Media I/O\ Camera manager for more details.
Encoder	Select Protocol: The available options are RTP, RTSP, or RTMP. Enter the primary and secondary URL/port number.

- **PTZ control** : The LS-110 is highly integrated with PTZ cameras and provides two control methods, Over IP or via Serial port.

Serial port	Select this option when the appointed camera uses RS-232 PTZ control protocol. Then complete the Serial port selection from drop list Port 1~4. See Media I/O\ PTZ control port for more details.
Over IP	The option is available when the specified signal type is a network camera. Select this option if that camera supports networking PTZ control.
Auto-Tracking Mount	Select IP address: Select from the TP-100 ip address drop list of those available. Select Tracking mode: off / Auto-Tracking / Auto-Tracking (pan only), the default is the Auto-Tracking. Note: A login authentication with the TP-100 might be required. See Media I/O\ Network device manager for more details.

### 1.1.1.2 Advanced configuration

A preview use and further configuration of the video input is provided. After the video input setting is successfully applied, click  to enter the advanced configuration page. In the case of a PTZ camera, the direction control panel, zoom in/out control bar, and up to 8 preset positions are enabled.

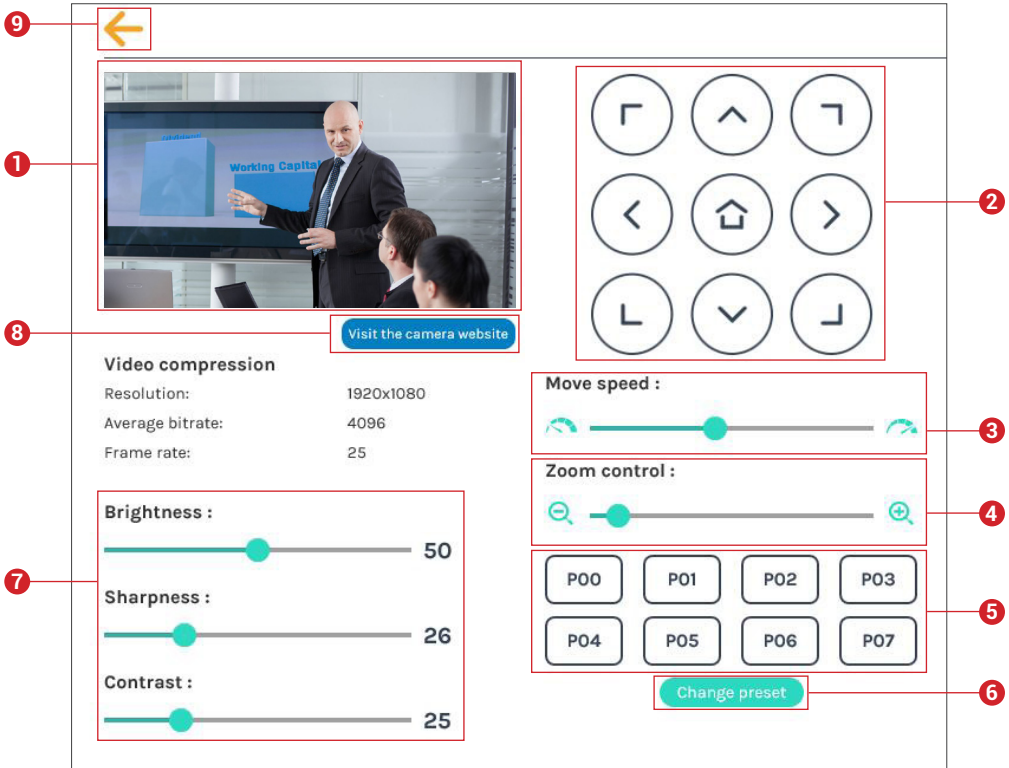

1. The video input preview.
2. Direction control panel: Click the arrow buttons to move the camera.
3. Movement speed: Move leftward or rightward to set slower or faster the camera is moving.
4. Zoom in/out: Click the buttons or drag on the control bar.
5. Preset positions: Click the buttons to command that the camera go to the preset position.
6. Change preset: Click the button to modify the preset positions. Select any of the P00~P07, move the camera to the desired position by using the direction control panel or using the zoom in/out control. Click Save button to complete the change or click Cancel button to give it up.  
 Note: If you use AREC CI-xxx network camera with TP-100, you can change preset of TP-100's Home.
7. Brightness, sharpness, and contrast: Slide the adjust bar leftward or rightward to change the camera image settings.
8. Visit the camera website: Click this [Visit the camera website](#) button to enter the webcam management web site, input the verification code as prompted.
9. Click  button at upper left corner to return to the last page.

### 1.1.2 Network device manager

The system automatically scans and lists the network cameras and Auto-Tracking Mount connected to the Media Station once entering the [ [Network device manager](#) ] page. You may click Refresh button to scan again. Click Login button and the login authentication dialog pop out.

Enter the username and password of the camera or Auto-Tracking Mount to complete the authentication. Take AREC network camera for example, enter the default username and password admin/ admin. The status then changes to OK, which indicates it is available for video input selection.

Note : If you fail to find your camera by clicking on "Refresh", please select "Signal type" to "Encoder" in the "Video Inputs" and fill in your camera information.

The screenshot shows the 'Network device manager' interface. On the left is a sidebar with navigation options: Media I/O, Video inputs, Network device manager, PTZ control port, Audio, Display, Video, Storage, Scheduler, Upload, System, and Account. The main content area is titled 'Network device manager' and contains two sections: 'Network cameras' and 'Auto-Tracking Mount'. Each section has a 'Refresh' button and checkboxes for 'LAN' and 'WAN'. Below each section is a table listing devices with columns for Host name, IP address, MAC, Brand, Status, and Connected.

Host name	IP address	MAC	Brand	Status	Connected
CW-210	10.2.50.148	E4:77:D4:00:DB:80	CW-210	OK	OK
CI-403	10.2.50.115	00:00:89:17:19:E3	CI-403	OK	OK
CI-200	10.2.50.116	00:00:89:0E:5163	CI-200	OK	OK

Host name	IP address	MAC	Brand	Status	Connected
TP100	10.2.50.104	BC:BA:E1:01:01:5C	AREC	OK	

The screenshot shows a 'Login authentication' dialog box with a close button (X) in the top right corner. It contains two input fields: 'User name :' and 'Password :'. Below the fields is a green 'Authentication' button. The background shows a blurred view of the 'Status' section of the interface with multiple 'Login' buttons.

### 1.1.3 PTZ control port

The LS-110 facilitate the web-based users control PTZ cameras using RS-232 protocol. Connect an USB-to-RS-232 adapter to the LS-110 back USB port in advance. Before making any changes to this page, please get to know about the RS-232 settings of the desired PTZ camera. The following configurations must be identical to the external device settings.

- Protocol : Available options are VISCA, PELCO-D, and PELCO-P;
- Address : Set according to the camera address for RS-232 communication. VISCA: 1-7, PELCO D/P: 1-255;
- Baud rate : 2400, 4800, 9600, and 115200

Note: Support USB to RS-232 serial port adapter with chip PL2303 or FT4232H.

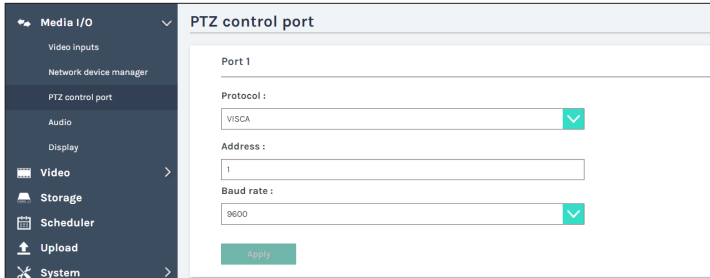

### 1.1.4 Audio

Adjust volume and select the audio input source.

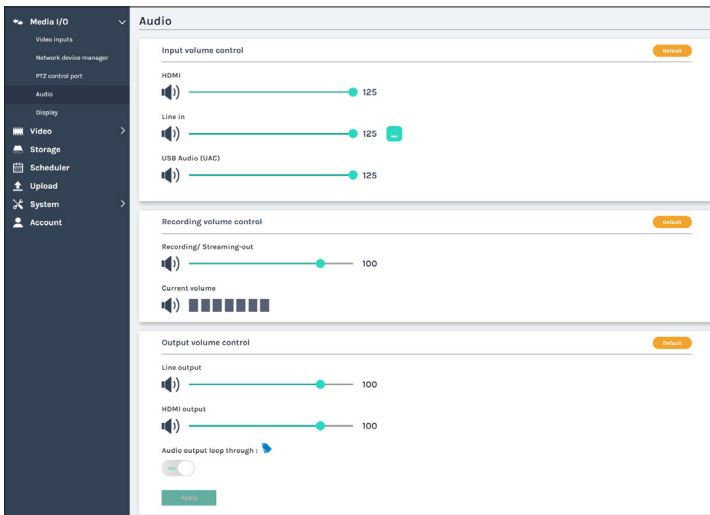

Audio: Users can control the input volume, Recording volume and Output volume. Configurable range of sound input is 0-125. The nearby volume meter indicates the encoded audio current volume.

Input volume control - Adjust the HDMI or Line in or USB Audio (UAC) volume.

Recording volume control - Adjust the Recording / Streaming-out volume.

Output volume control - Adjust the Line output or HDMI output volume. Set Audio output loop through on/ off.

### 1.1.5 Display

Set the LS-110 on screen display language and screen color adjustment.

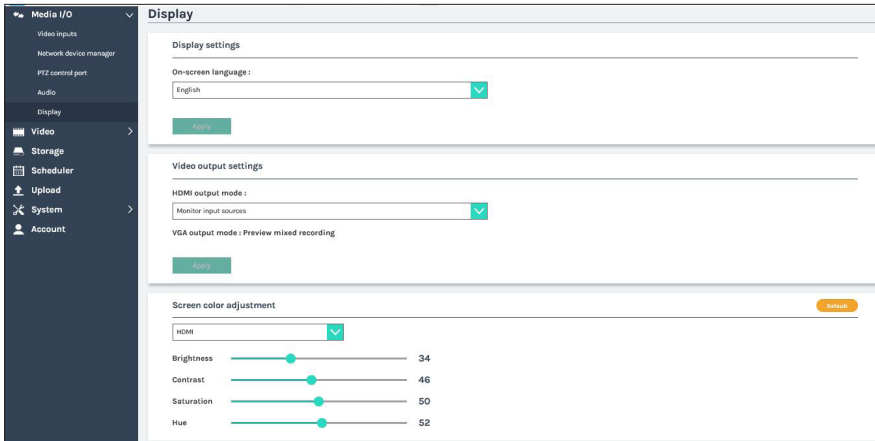

On-screen language: Change the GUI language.

Screen color adjustment: Change the Brightness, Contrast, Saturation and Hue

### 1.2 Video

The pages within Video construct a collection of settings that defines the operating characteristics for a streaming/recording, include:

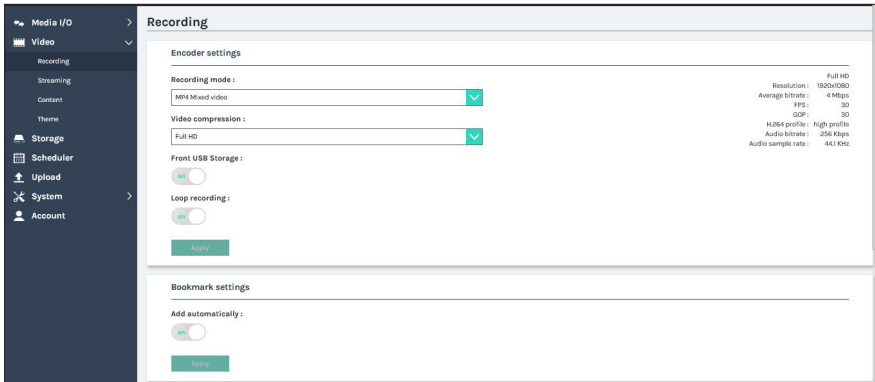

Recording	Configure Encoder settings and Bookmark settings for recording.
Streaming	Configure Encoder settings for streaming.
Content	Edit the information of the content that will be recorded.
Theme	Set the overlay files, background images and theme types.

## 1.2.1 Recording

Set up the [Encoder settings](#) and [Bookmark settings](#) for recording.

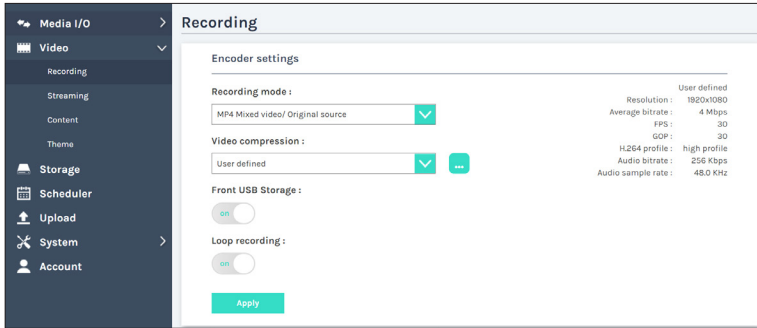

### Encoder settings

- Recording mode: Available options are MP4 Mixed video and MP4 Mixed video/ Original source.
- Video compression : There are 7 preset recording video compression profiles for different resolution and bitrate. Select one to see the option details on the right side. You may customize your own user defined option.
- Front USB recording : Set ON/OFF to enable/disable LS-110 front USB recording function. Make sure the front USB drive connected can be normally read and written and have enough space for the recorded files.
- Loop recording : Set ON/OFF to enable/disable LS-110 local storage recording rule.

Click Apply button at the bottom corner when finished to apply the settings.

Profile name	Video Resolution/ Bitrate	Application description
Full HD	1080p/ 4Mbps	Dynamic scene and large local hard disk recording.
Internet Full HD	1080p/ 3Mbps	General scene and medium local hard disk recording.
HD	720p/ 2Mbps	Static scene and small local hard disk recording.
Internet HD	720p/ 1.5Mbps	Live broadcasting through the Internet.
SD	480p/ 800kbps	Static scene for live broadcasting through the Internet.
Mobile SD	480p/ 500kbps	Live broadcasting for portable mobile devices watching.

Click button to open customization window as shown below, and click Save button to make the option changed.

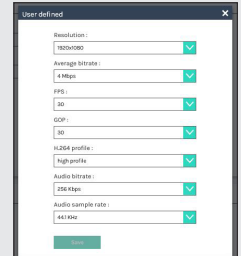

User defined

Bookmark settings- Set ON/OFF to enable add bookmark automatically.  
Click Apply button at the bottom corner when finished to apply the settings.

**Bookmark settings**

---

**Add automatically :**

on

Add prefix to video filename: Use this description is added to the Video filename as a prefix string for Download and Upload.

**Recording file name setting**

---

**Prefix setting :**

Audio shift- Adjust the delay of sound after video transmission. Synchronize the video and audio with consistency.

**Audio settings**

---

**Audio shift :**

100 ms

## 1.2.2 Streaming

AREC Media Station support two streaming address with same video compression. The page provides user to change streaming settings. It is essential that the configurations follow the streaming protocol and recommended settings your server system supports.

- Media I/O >
- Video** >
- Recording
- Streaming
- Content
- Theme
- Storage
- Scheduler
- Upload
- System >
- Account

**Streaming**

---

**Encoder settings**

**Video compression :**

Internet HD  
Resolution : 1280x720  
Average bitrate : 1.5 Mbps  
H264 profile : high profile

---

**Streaming 1 settings**

**Live streaming :**

**URL :**

---

**Streaming 2 settings**

**Live streaming :**



Video compression profile – There are 7 streaming video compression profiles for different resolution and bitrate. Select one to see the option details on the right side. You may customize your own user defined option. Click  button to open customization window as shown below, and click Save button to make the option changed.

Click Apply button at the bottom corner when finished to apply the settings.

Note: The resolution for streaming cannot be larger than that for recording.

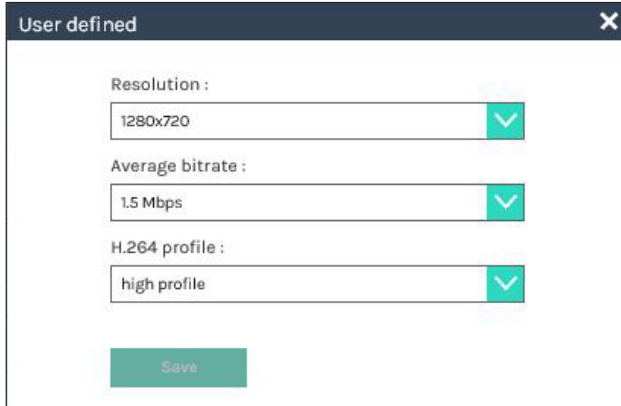

A screenshot of a 'User defined' settings window. It has a dark blue header with the title 'User defined' and a close button (X). The window contains three dropdown menus, each with a green checkmark icon on the right:

- Resolution : 1280x720
- Average bitrate : 1.5 Mbps
- H.264 profile : high profile

At the bottom left, there is a green 'Save' button.

Live streaming : Select OFF/ Together with recording/ Streaming always/ Enable streaming button to setting live streaming ability.

Together with recording : Streaming and recording simultaneously

Streaming always : LS-110 always streaming

Enable streaming button : Enable streaming On/Off button on GUI and Online Director

Click  button to open customization window as shown below, RTMP username/password and test for Wowza. Click Save button to make the option change.

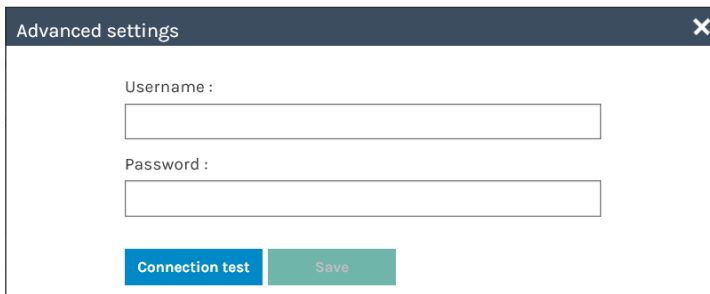

A screenshot of an 'Advanced settings' window. It has a dark blue header with the title 'Advanced settings' and a close button (X). The window contains two text input fields:

- Username :
- Password :

At the bottom, there are two buttons: a blue 'Connection test' button and a green 'Save' button.

URL – The available protocol on the LS-110 are RTP and RTMP, the URL format is as follows :

RTMP	In the protocol setting field, copy and paste the Server or Stream URL and Stream name provided by you CDN or server administrator in the format <code>rtmp://serverurl/streamname</code> .
RTP	Enter the destination IP address and the port number where the streaming is played in the format <code>rtp://@:1234</code> . For example, <code>rtp://226.10.24.32:7000</code>

Followings are some popular examples for streaming settings.

**Streaming to Facebook Live**

Copy the contents of the Single Field, Server or Stream URL, and paste in the LS-110 streaming protocol setting field.

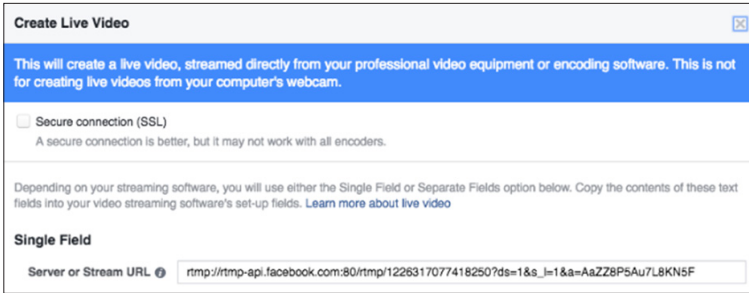

**Streaming to Ustream**

Combine the contents of both fields: RTMP URL and Stream Key, insert a slash between them. Paste this string into the LS-110 streaming protocol setting field. For example: `rtmp:1.15059865.fme.stream.tv/ustreamVideo/15059865/5gmbz4RCa2Hgt9SwtCYuCct6qS137Nar`

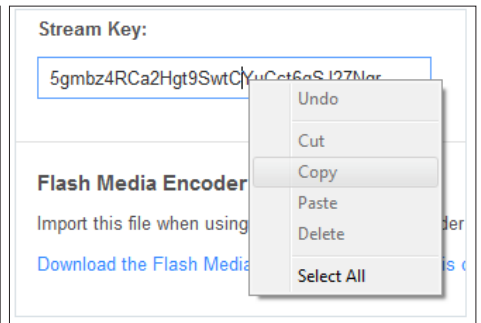
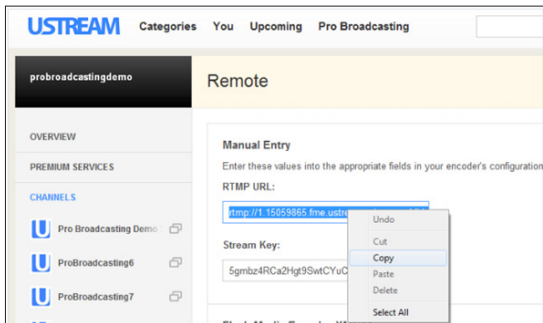

**Streaming to YouTube Live**

Combine the contents of both fields: Primary Server URL and Stream Name, insert a slash between them. Paste this string into the LS-110 streaming protocol setting field.

Streaming to a media player on a PC in the same LAN with the LS-110

Enter the destination IP address and the port number where the streaming is played in the format `rtp://@:1234`.

Unicast: For a single point connection, the destination IP must be set to the location where the stream is played.

Multicast: The destination IP must be multicast IP address where it can be shared with multiple viewers. (Note: Multicast IP address= 224.0.0.1~239.254.254.254, available port number range= 1-65535)

To view the stream from a media player, open the URL in a media player, such as:

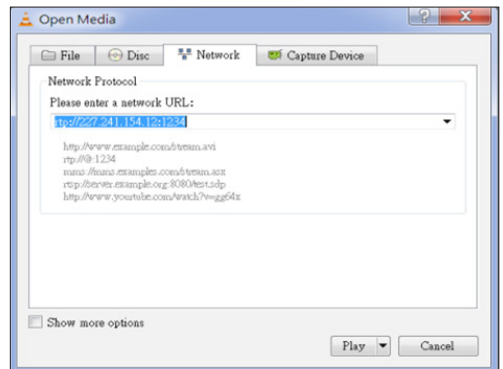

### 1.2.3 Content

The LS-110 contains up to 13 user-configurable elements for describing content. These elements and texts will be saved in the recording data of the newly created content. Enter text in the content settings fields if desired. Click Apply button at the bottom corner when finished to apply the settings.

Note: These updates do not apply to the existing recordings. To edit the existing recording information, see Video Manager.

**Content**

Content settings

Title :

Organization :

Department :

Event\_date :

Semester :

Topic :

Level :

Audience :

Room :

Category :

### 1.2.4 Theme





LS-110 by factory default provides three overlays, three backgrounds and four themes.

**Overlay** : Select and delete the overlay. Click [  ] button and select the desired file in the Open dialog box. The file name would appear with the newly uploaded image. Click Apply button at the bottom corner to apply the settings, or click [ **Delete** ] Cancel to give it up.

Note: The overlay file must be in PNG format, maximum size 1920px\*1080px.

Note: The user can use the mouse to drag the order of the display.

Overlay 

   

**Delete**

**Background :** Select and delete the background. Click [ + ] button and select the desired file in the Open dialog box. The file name would appears with the newly uploaded image. Click Apply button at the bottom corner to apply the settings, or click [ Delete ] Cancel to give it up.

Note: The background file must be in PNG format, maximum size 1920px\*1080px.

Note: The user can use the mouse to drag the order of the display.

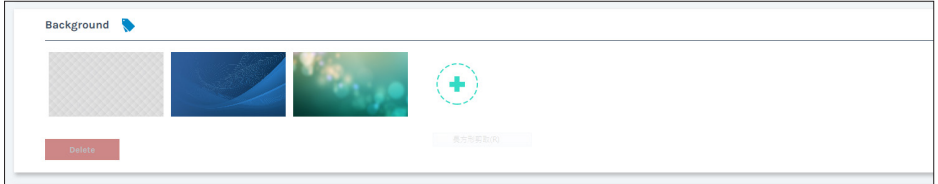

**Theme :** Theme is integrated with "Overlay", "Background" and "Layout". LS-110 by factory default provides four themes by different types of overlays, backgrounds and layouts. Click [ + ] to set the theme type. Input the theme name, and select the desired type of overlay, layout and background. Click Apply button at the bottom corner to apply the settings.

Note: The user can use the mouse to drag the order of the display.

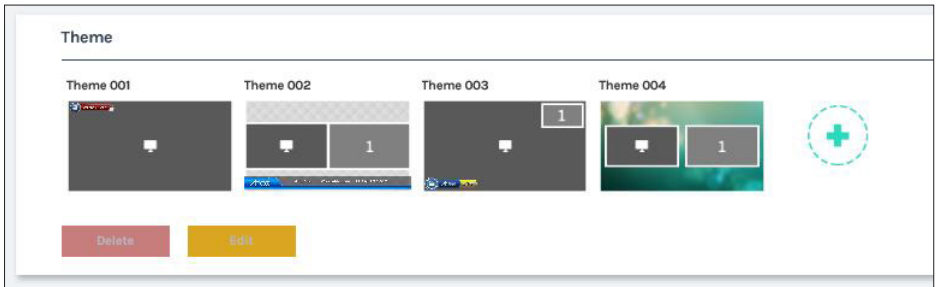

## 1.3 Storage

The recording files produced by the LS-110 are stored on its own internal drive. This page provides user to set local storage drive or USB and reveals the disk information in the lower section.

The screenshot displays the 'Storage' configuration page. On the left is a navigation menu with options: Media I/O, Video, Storage, Scheduler, Upload, System, and Account. The main content area is titled 'Storage' and is divided into two sections: 'Record disk settings' and 'Disk information'.

**Record disk settings:** This section includes a 'Local storage' dropdown menu currently set to 'Internal (SATA HDD)' with a green checkmark. Below the dropdown is a green 'Apply' button.

**Disk information:** This section contains a table with the following data:

Interface	Disk name	Brand	Capacity	Free Space	Format
SATA	Internal (SATA HDD)	ATA WDC WD10SPZX-00Z	1916.89 GB	869.21 GB	Format

Record disk settings-

Local storage: The internal drive(SD Card) of LS-110 is preset for storing the recorded files.

Click Apply after setup is completed. New setting takes effective from next recording being created.

Disk information- Displays disk information, available storage space and total capacity. Click "Format" to clean up the internal storage drive. A dialog box opens asking you to confirm the disk formatting. Click Confirm to permanently delete all recording packages.

## 1.4 Scheduler

The Schedule Settings page allows the administrator privileges to choose how to obtain presentation schedules and, if appropriate, import calendars or connect to an Opencast, Panopto or Kaltura scheduling system. Start video recording automatically at the date and time specified in a calendar schedule.

Available options are Scheduling via Opencast server, Scheduling via Panopto server, Scheduling via Kaltura server, Manual Calendar import, and Periodic Calendar import.

In addition, users can also set Auto text overlay on/ off.

Scheduling via Opencast server : Centralized Scheduling via Opencast server  
 Scheduling via Panopto server : Centralized Scheduling via Panopto server  
 Scheduling via Kaltura server : Centralized Scheduling via Kaltura server  
 Manual Calendar import : Importing iCalendar files manually  
 Periodic Calendar import : Importing iCalendar files automatically

Disable Recording functions if Schedule Record is on

- Local director : record button
- Online director : record buttons (record / pause / stop)
- Front Panel (record / stop)
- USB Keyboard (record / pause / stop)
- Front USB recording off

## Scheduler



Date	Start time	End time	Presenter	Room	Title	Description
2019-04-01	18:00:00	19:00:00	arec.com_oqnplif...		Busy	

1

### Recording interruption

Cancel ongoing recording task :

Stop

Recording interruption : Manually stop current schedule

Click  Open Scheduled Events page.

### Scheduling via Opencast server

- Enter the Capture agent name, Username, Password and iCalendar URL in these fields.
  - Capture agent name: the ID to recognize LS-110 on Opencast platform
  - Username: Opencast user account
  - Password: Opencast user password
- Click Apply. The event schedule is added and appears in the calendar on the Scheduled Events page.
- Go to Opencast admin, and check if the LS-110 is correctly registered on Opencast.

**Schedule settings** 

off

**Schedule source :**

Scheduling via Opencast server 

**Capture agent name :**

**Username :**

**Password :**

**URL :**

Apply

"Opencast Admin" -> "Capture" -> "Locations"

The screenshot shows the Opencast Admin interface. The top navigation bar includes the Opencast logo, a US flag, a refresh icon, a notification bell, a help icon, and the user name 'Opencast Project Administrator'. The main content area is titled 'Locations' and shows a table with 3 rows. A red box highlights the camera icon in the left sidebar, and another red box highlights the row for 'LS-110\_020EAO' in the table.

Status	Name	Last updated	Actions
idle	KS-506_MelodyCCC	Today at 2:42 PM	[Menu]
idle	LS-110_020EAO	Today at 3:55 PM	[Menu]
idle	smp-science80	Today at 3:55 PM	[Menu]

**Scheduling via Panopto server**

1. Enter the Capture agent name, Registration key and URL in these fields.  
Note: Get the registration keys token for scheduler in Panopto System
2. Click Apply.
3. Go to Panopto System => Remote Recorders, and Your AREC media station will list up in your Panopto account as a remote recorder.

The screenshot shows the 'Schedule settings' form. The 'Schedule source' is set to 'Scheduling via Panopto server'. The 'Capture agent name' is 'KL-3\_021046', the 'Registration key' is masked with dots, and the 'URL' is 'https://arec.panopto.com'. An 'Apply' button is at the bottom.

The screenshot shows the 'Remote Recorders' page in the Panopto System. A red box highlights the entry for 'LS-110\_021E3C (60.248.164.121)'.



### Scheduling via Kaltura server

1. Enter the URL(https://www.kaltura.com), Capture agent name, Username and Password in these fields. Click Apply.
  - a. Capture agent name: the ID to recognize LS-110 on Kaltura platform
  - b. Username: Kaltura user account
  - c. Password: Kaltura user password

#### Schedule settings

off

**Schedule source :**

Scheduling via Panopto server ▼

**Capture agent name :**

KL-3\_021046

**Registration key :**

•••••

**URL :**

https://arec.panopto.com ✕

Apply

2. Enter the Kaltura MediaSpace. Select "My Calendar" from the user drop down menu.

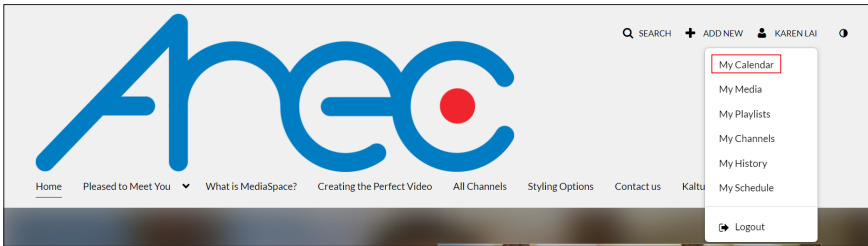

3. After entering the "My Calendar" page, click "Create Event" to create a schedule. Fill in "Event Title" and select "Resource"\*. Click " Save" to complete the setting.
- \* Please select the preset "Recording device name" as Resource.

#### Create Event

Event Title:  (Required)

Event Organizer:  (Required)

Karen Lai

(Time Zone: GMT)

Start Time:

End Time:

Description:

Tags:

Copy details from event to recording:

Save
Save and Exit
Cancel

### Manual Calendar import

1. Click Import. An Open window opens.
2. Locate and select the iCalendar file for import. The file must have a .ics file extension.
3. Click Open. The Open window closes and the file name is displayed within the Manual Calendar Import panel area. The Import button is active.
4. Click Apply. The event schedule is added and appears in the calendar on the Scheduled Events page.

#### Schedule settings

---

on

Schedule source :

Manual Calendar import 

Load a configuration. 

### Periodic Calendar import

1. Enter the iCalendar URL in this field.
  2. Click Apply. The event schedule is added and appears in the calendar on the Scheduled Events page.
- Note: iCalendar Schedule can not be set to cycle, only accept single. Cannot set more than 2 pens to start at the same time. When setting the time overlap, the start time whichever is earlier.

#### Schedule settings

---

on

Schedule source :

Periodic Calendar import 

URL :

## 1.5 Upload

The LS-110 is able to automatically upload recordings from its internal drive to a network server. In this page, user can configure the upload destination and tests the connection.

The screenshot displays the Arec LS-110 Administrator interface. On the left is a dark sidebar with navigation options: Media I/O, Video, Storage, Scheduler, Upload (highlighted), System, and Account. The top right of the interface shows 'LS-110 Administrator' and several status icons. The main content area is titled 'Upload' and contains two sections:

- Upload settings:**
  - Auto upload:** A dropdown menu set to 'OFF'.
  - Delete after uploading:** A toggle switch set to 'off'.
  - Upload files:** A dropdown menu set to 'All recorded files'.
  - An 'Apply' button is located below these settings.
- Transfer settings:**
  - Mode:** A dropdown menu set to 'FTP'.
  - URL:** An empty text input field.
  - Port:** An empty text input field.
  - Folder:** An empty text input field.
  - Authentication:** A dropdown menu set to 'Normal'.
  - Username:** An empty text input field.
  - Password:** An empty text input field.
  - An 'Apply' button is located below these settings.
  - To the right of the input fields is a blue button with a cloud and server icon, labeled 'Connection test'.

## 1.5.1 Upload settings

### Upload settings

---

**Auto upload :**

OFF
▼

**Delete after uploading :**

off

**Upload files :**

All recorded files
▼

Apply

1. Auto upload: Available options are OFF, After recording is completed and Daily scheduled
  - a. After recording is completed: Upload the files after recording
  - b. Daily scheduled: Setup start & End time for uploading, Enable this setting Media Station will in "full speed mode" for uploading.

**Auto upload :**

Daily scheduled
▼

**Start time**

00

:

00

**End time**

00

:

00

⚠ Please stop daily schedule uploading 30 minutes before your next schedule recording event.

2. Delete after uploading on/off: Enable auto delete the files after uploading
3. Upload files: Available options are All recorded files, Mixed video and Original source

### 1.5.2 Transfer settings

**Transfer settings**

---

**Mode :**  
 ▼

**URL :**

**Port :**

**Folder :**

**Authentication :**  
 ▼

**Username :**

**Password :**



Connection test

Followings to be configured according to the upload destination.

**Mode:** Select network server type (FTP, SFTP, Kaltura, Panopto, Opencast HTTP, Opencast HTTPS).

**URL, port, or User ID:** Configure these fields according to the upload destination.

**Folder:** Enter the folder name of the upload destination.

**Authentication:** Configure this section according to the upload destination authentication method.

**Connection test-** Click the Connection test button to validate upload settings.

Click Apply after setup is completed. New setting is effective from next recording being created.

The upload status/result of the corresponding recordings is denoted in the Video Manager web pages.

**Note :** If the web server is Opencast, the video title and the creator description are automatically filled with the title and presenter of the Director's content settings.

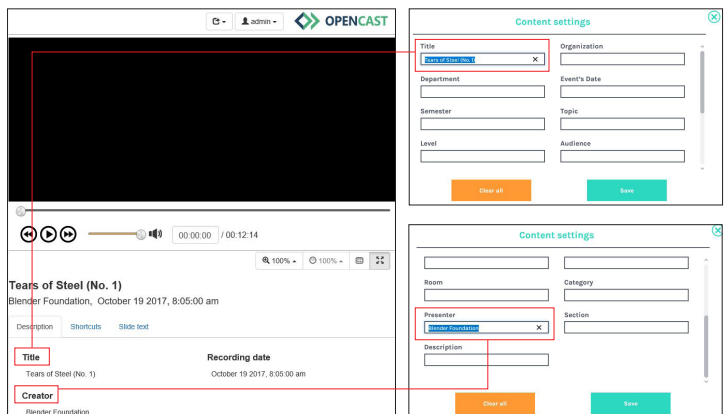

The screenshot shows the Opencast interface. On the left is a video player for 'Tears of Steel (No. 1)'. The 'Title' and 'Creator' fields in the video player are highlighted with red boxes. On the right are two 'Content settings' forms. The top form has 'Title' and 'Presenter' fields highlighted with red boxes. Red lines connect the video player's 'Title' to the content settings 'Title' and the video player's 'Creator' to the content settings 'Presenter'.

## 1.6 System

The pages within System include the following:

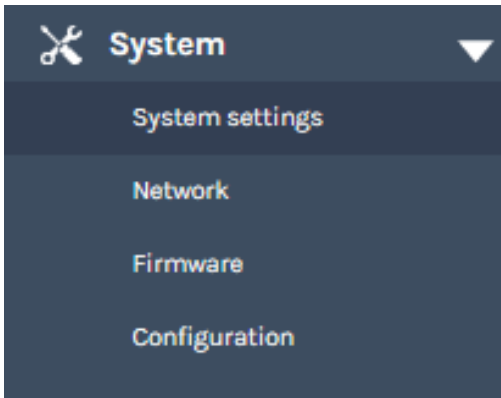

System settings	Contains device identification, date and time configuration, and booting settings.
Network	The device IP assignment in the networking.
Firmware	Displays the current firmware version, and provides web-based user a way to update firmware for the device.
Configuration	Export / Import the configuration.

## 1.6.1 System settings

The basic information and initial date/time of this device are configured here.

The screenshot shows the 'System settings' page for an Arec LS-110 device. The left sidebar contains navigation options: Media I/O, Video, Storage, Scheduler, Upload, System (selected), System settings, Network, Firmware, Configuration, and Account. The main content area is titled 'System settings' and includes the following sections:

- Device identification:** Fields for Hostname (LS-110), Device description (LS-110), Brand (LS-110), Arec no., Model (LS-110), and Serial number (LS-110). A note states: 'Hostname follows RFC 802 Internet host table specification.' An 'Apply' button is at the bottom.
- Date and time:** 'Device current date and time' is 2021-04-14 14:33:18. 'Time zone' is Asia/Taipei. 'Setting mode' is NTP service. 'NTP server url' is pool.ntp.org. An 'Apply' button is at the bottom.
- Boot image:** Shows a preview of the Arec boot image. A 'Browse' button is next to it. To the right, file details are shown: File format: PNG, Size (Max.): 3 MB, Resolution(Max.): 1920x1080. An 'Apply' button is at the bottom.
- Power:** 'Power mode' is boot-up with power button. 'Auto power off' is OFF. 'Auto power on' is OFF. An 'Apply' button is at the bottom.
- Web server protocol:** A note says 'The system will reboot after changing the network setting. Please log in, again.' The 'Protocol' is HTTPS. An 'Apply' button is at the bottom.
- Restart device:** A 'Restart' button is at the bottom.

Device identification – Set the name (device description) for this device.

Date and Time – Set the device date, time, and time zone manually/ be synchronized to PC, or with an external NTP (network time protocol) server.

Boot image – Change the boot screen image. The boot screen is the image you will see when you boot up the device.

Click Browse button and select the desired file in the Open dialog box. The file name would appears with the newly uploaded image. Click Apply button at the bottom corner to apply the settings, or click **Cancel** Cancel to give it up.

Power – Choose how to turn on the device.

Note: The boot screen file must be in PNG format, maximum size 1920x1080px.

Web server protocol – change the protocol

Restart device – Restart

## 1.6.2 Network

By default LS-110 uses DHCP to obtain an IP Address via a router or any DHCP server. To use a static IP address for your device, configure the network settings in this webpage.

**Network**

**Network settings**

The system will reboot after changing the network settings. Please re-login.

IP assignment :  
DHCP

IP address :  
10.2.50.151

Subnet mask :  
255.255.255.0

Default gateway :  
10.2.50.254

Primary DNS Server :  
10.100.0.1

Secondary DNS Server :

Apply

IP assignment – Select DHCP to have IP address be allocated by a router or any DHCP server being connected; or Select Static IP and enter the required network settings including IP address / subnet mask / default gateway/ DNS server.

Click Apply at lower right corner, click Confirm in popup dialog box.

Note: The system will automatically reboot to complete the network settings. Login the updated IP address after the system restarts.



### 1.6.3 Firmware

This page displays the device firmware version. To update the firmware, click "Update" and a dialog box opens asking you to select the file. Select the desired file and click "Open", the dialog box closes and the file name appears underneath. Click "Apply" to start firmware update. Click "Cancel" if the uploaded file is no longer wanted.

Note: System will reboot automatically when the firmware update is completed. It might takes a few minutes. Do not shutdown/ power off the system during firmware updating.

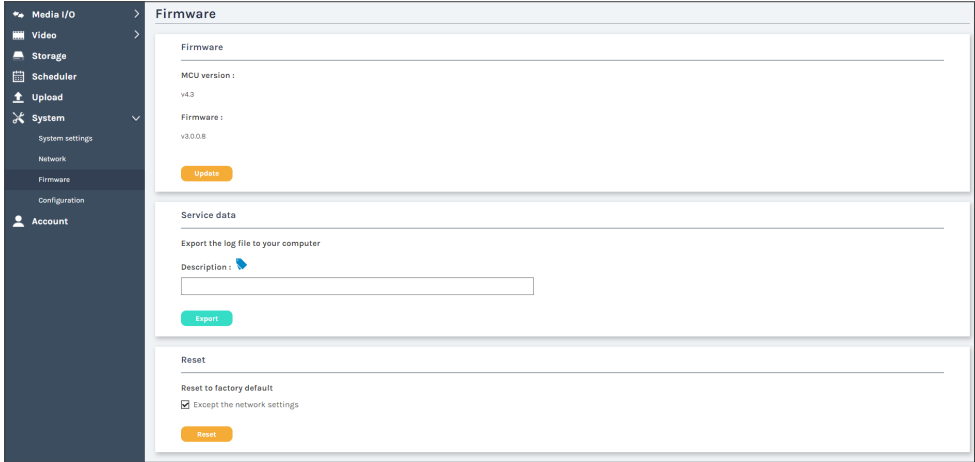

**Service data** : Export the log file to your computer or upload it to the Customer Service Server. Input the file name, and then click "Export" or "Upload".

Note : The length of the string is 0~16 characters, allowing letters, numbers, symbols 11(~!@\$%^&\*+\_-).

**Reset** : Reset to factory default. Check if you want to keep your network settings, and click "Reset". The dialog pop out and ask you "System will reboot after updating, continue?"  
" Click "Confirm" to start reset.

### 1.6.4 Configuration

You can export or import the configuration in this page:

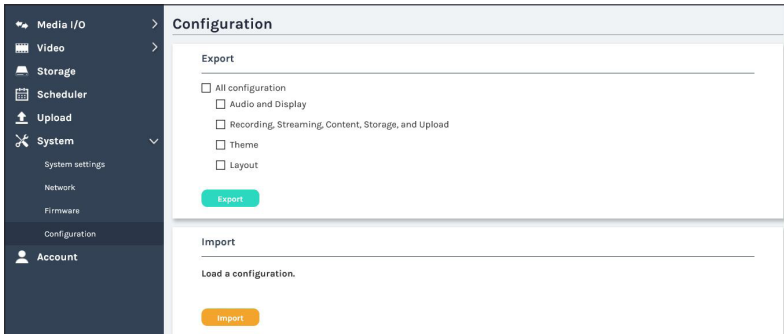

**Export** : Select the configuration to export and click "Export".

**Import** : Click "Import" to load a configuration.

## 1.7 Account

Users can set the system account password etc.

The screenshot displays the 'Account management' section of the Arec interface. On the left is a dark sidebar with navigation icons for Media I/O, Video, Storage, Scheduler, Upload, System, and Account. The main content area is titled 'Account management' and contains three user management sections:

- Administrator**: Username: admin, New password: [input], Confirm password: [input], Apply button.
- Online Director**: Username: director, New password: [input], Confirm password: [input], Apply button.
- Video Manager**: Username: video, New password: [input], Confirm password: [input], Apply button.

Changing username and password with Administration/ Online Director / Video Manager :

- (1) New User: Enter a user login name that you want.
- (2) New Password: Enter the user login password that you want.
- (3) Confirm Password: Requires you to enter your password again for confirmation.
- (4) Click Apply.

## Chapter 2 Director

### 2.1 Local Director

The LS-110 Local Director operates on the screen after the USB port is connected to the mouse or projector. GUI allow user to control recording and have a live stream view on the display. This director control panel makes it easy to apply layout, select background, and control the audio recorded during the recording process.



#### 2.1.1 Preview

This section briefly introduces the names of the various function buttons, and the functions will be introduced in the next section.



	Minimum / Maximum	00:00:00	Record Timer		Playback
	Overlay		Streaming On/Off		Settings
	Layout		Record		Camera Control
	Background		Pause	10.2.50.152	IP Address
	Theme		Stop		Audio Volume
	Stream Status		Snaoshot		Display

## 2.1.2 Toolbar

Here will introduce the function of all buttons. We divide the function into many small parts to introduce it for easy reading.

### 2.1.2.1 Theme and Display

There are five buttons for quickly switching recording overlay, layout, background, theme and display.



Name : Overlay  
 Function : Change Overlay  
 Brief introduction :

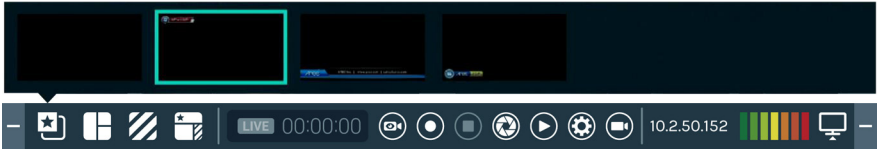

Name : Layout  
 Function : Change Layout  
 Brief introduction :



Name : Background  
 Function : Change Background  
 Brief introduction :

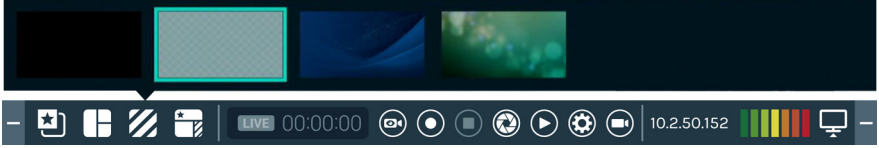

Name : Theme  
 Function : Change Theme  
 Brief introduction :



Name : Display  
 Function : Change Content / Cam 1 / Mixed video cycling  
 Brief introduction : Switch image sources to monitor individual image inputs.

The video output settings display Monitor input sources or Preview mixed recording, please refer to 1.1.5 Display

## 2.1.2.2 Recording, Streaming control and Snapshot

1. There are four buttons for quickly control video recording

Name	Function	Description
 Status	Streaming status	Status change to red while LS-110 live broadcast
00:00:00 Timer	Record timer	Timer change to red while recording
 Streaming	Streaming On/Off	When administrator streaming setting : Enable streaming button
 Record	Video recording	The Record button is red to indicate active recording
 Pause	Pause recording	The preview video are suspended. To resume recording, click Record.
 Stop	Stop to end a recording	-
 Snapshot	Screen shot of the preview.	When not recording, the picture will be placed in the snapshot folder of the internal hard drive or front USB, and will appear in the Video Manger. When recording, the picture will be placed in the data set of the video(see 3.1.4 NO.6), and when the snapshot is taken, the bookmark will be automatically added.

2. video recording

**Limitation**

1. Video length(Max.) : 8hr
2. If Front USB is FAT32, USB record size only 4 GB space time.

**Rule**

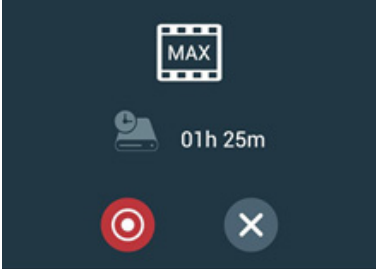
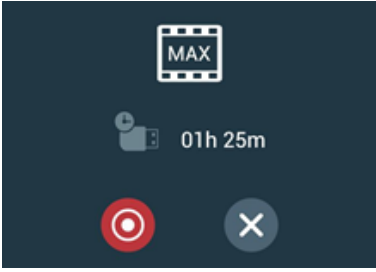
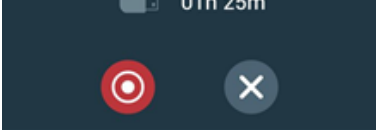
<p>1. Loop recording off</p> <ol style="list-style-type: none"> <li>a. Front USB recording off : If internal hard drive &lt; 8hr : max = internal hard drive, show the dialog</li> <li>b. Front USB recording on and internal hard drive &lt; USB             <ul style="list-style-type: none"> <li>• If internal hard drive &lt; 8hr : max = internal hard drive, show the dialog</li> </ul> </li> </ol>	
<p>2. Loop recording off</p> <ol style="list-style-type: none"> <li>c. Front USB recording on and internal hard drive &gt; USB             <ul style="list-style-type: none"> <li>• If USB &lt; 8hr : max = USB, show the dialog</li> </ul> </li> </ol>	
<p>3. Loop recording on (internal hard drive = 8hr)</p> <ol style="list-style-type: none"> <li>a. Front USB recording on and internal hard drive &gt; USB             <ul style="list-style-type: none"> <li>• If USB &lt; 8hr : max = USB, show the dialog</li> </ul> </li> </ol>	

2.1.2.3 Playback Video

■ Video list Dialog

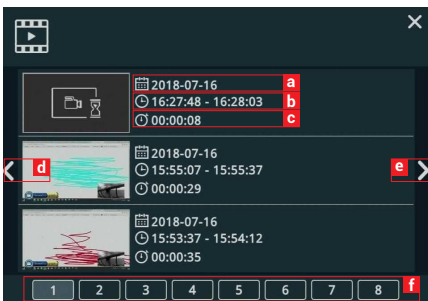

Show all videos saved in hard drive, three videos in one page.

- a. Date of video
- b. Start-End time of video
- c. Total time of video
- d. File list page up
- e. File list page down
- f. Video list pages, click to jump to different video list page.

■ Playback mode functions



Name	Function	Description
 Play/ Pause	Play/Pause video	While the video is playing, click to pause and click again to resume
 Time bar	Show playback progress in bar	Click any point on the bar will jump to correspondent time
00:00:00 Time 00:00:02 Information	Total recording time & current playback time	-
 Audio On/Off	Mute or resume playback audio	-
 Volume bar	Show playback volume level	Click any point on the bar will adjust to correspondent volume level
 Bookmark	Bookmark of video	(The dialog will be introduced below.)
 Switch sources	Change playback source	-
 Mixed video	Playback Mixed video	-
 Content	Playback Content video	-
 Cam 1	Playback Cam 1 video	-
 Exit	Exit the playback mode	-

■ Bookmark

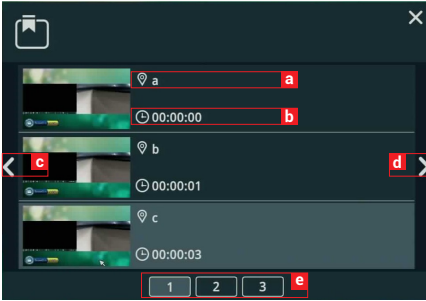

Show all Bookmark list attached with this playback video,three Bookmark item in one page.

- a. Bookmark Title
- b. Time Point
- c. Bookmark list page up
- d. Bookmark list page down
- e. Bookmark list pages,click to jump to different video list page.

### 2.1.2.4 Settings

1. Information

a. Show device information:Hostname/ Device description/ IP address/ Model/ Version/ Brand



2. Audio In / Out

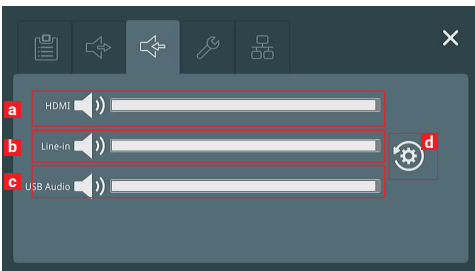

Audio Input Volume Control

- a. HDMI : Mute/ Down/ Up
- b. Line-in: Mute/ Down/ Up
- c. USB Audio : Mute/ Down/ Up
- d. Default



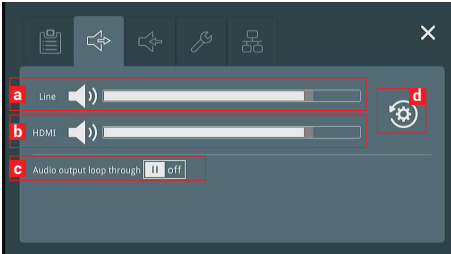

**Audio Output Volume Control**

- a. Line : Mute/ Down/ Up
- b. HDMI : Mute/ Down/ Up
- c. Audio output loop through : On/Off

Note : Audio Loop-through Off : Local audio output does not include local audio input (Audio 1, Audio 2, Wireless Microphone and USB Microphone)

- d. Default (Volume only)

2.1.2.5 Others

Name	Function	Description
10.2.50.152	IP Address	Device WAN IP Address
	Audio Volume	Audio volume meter

## 2.2 Online Director

The LS-110 embedded Online Director web pages allow user to control recording and have a live stream view of the output video. This director control panel makes it easy to apply layout, select background, and control the audio recorded during the recording process.

Entering the Online Director webpage via [Administrator] by clicking the  button or login Online Director from the initial login page with default username director and password director. Both ways lead to the Online Director control panel for web-based users.



These Web pages provide the following features and information about:

1. A live view window and a control panel of the LS-110 recording and streaming.
2. A visual sources monitoring exclusive panel which allow user to control and monitor the cameras providing the video source.
3. After users click the  button, they can add and edit the text overlay. Users can also adjust the font format.
4. A Video Manager hyperlink to manage the content stored in the LS-110.
5. Device description, which is configurable for system Administrator, indicates the device location...etc.
6. Storage capacity which is converted into remaining time for recording.
7. Recording/ Streaming status and timer.
8. Recording/ Streaming control and Snapshot buttons.
9. Audio volume meter indicates the audio volume of the content being recorded and streamed.

## 2.2.1 Recording controls panel

There are five tab panels for quickly switching recording background,layout,overlay,theme, and adjusting volume.

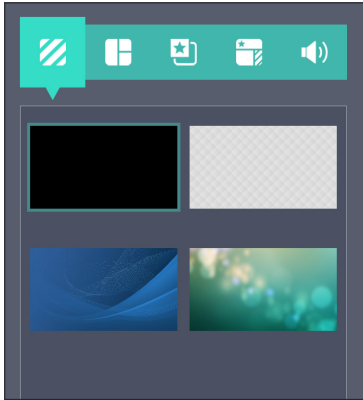

### 2.2.1.1 Background

Display the available background images for Online Director controlling. Click the background thumbnail to apply it to the video. LS-110 by factory default provides one plain black background and three user-configurable backgrounds. See Administrator \ Video \ Theme for more detail.

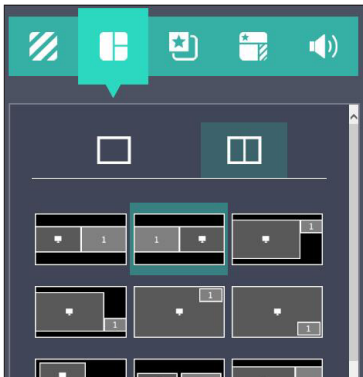

### 2.2.1.2 Layout

There are layout templates which are factory default layouts and pre-defined into four groups. User can apply layout to the live view window, recording session, and web streaming all at once. Click the layout template to select the desired layout.

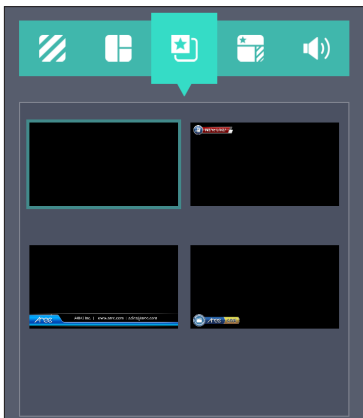

### 2.2.1.3 Overlay

LS-110 by factory default provides one plain black overlay and three user-configurable overlays. Click the overlay thumbnail to apply it to the video. See Administrator \ Video \ Theme for more details.

### 2.2.1.4 Theme

Theme is integrated with "Overlay", "Background" and "Layout". LS-110 by factory default provides themes by different overlays, backgrounds and layouts. See Administrator \ Video \ Theme for more details.

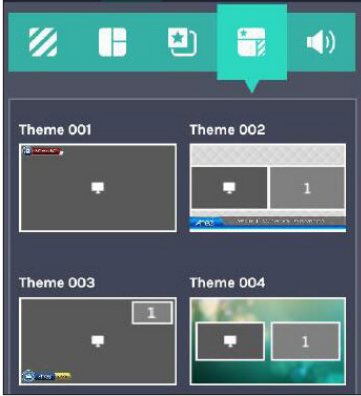





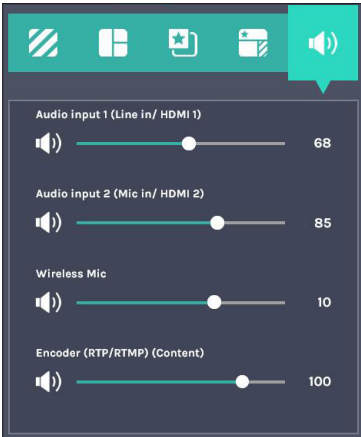



### 2.2.1.5 Volume control

The audio control bar is to adjust the recorded volume from each audio input and adjust the output volume. Adjustable range of sound input is 0-125, AREC wireless microphone 0~15.



## 2.2.1.6 Recording/ Streaming control and Snapshot buttons

Buttons are:

	Streaming setting	When administrator streaming setting Together with recording
	Live streaming	LS-110 live broadcast
	Streaming	Streaming on/off (When administrator streaming setting Enable streaming button)
	Record	Click Record and recording begins. The Record button is red to indicate active recording.
	Pause	Click Pause to pause recording. The preview and the output video are also suspended while recording is paused. To resume recording, click Record.
	Stop	Click Stop to end a recording
	Scheduler	Schedule record on
	Snapshot	Screen shot of the preview. When not recording, the picture will be placed in the snapshot folder of the internal hard drive or front USB, and will appear in the Video Manger. When recording, the picture will be placed in the data set of the video(see 3.1.4 NO.6), and when the snapshot is taken, the bookmark will be automatically added.

## 2.2.2 Visual Sources Monitoring

It makes easy for user to control and monitor each video input. Click the tab with the video input name on it to switch the monitoring window. In the case of a PTZ camera, the direction control panel, zoom in/out control bar, and up to 8 preset positions are enabled.

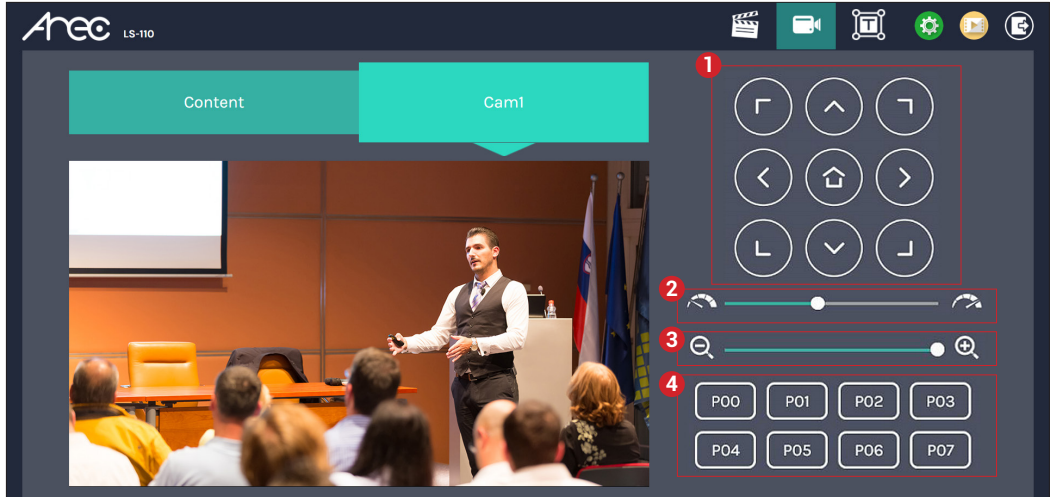

1. Direction control panel: Click the arrow buttons to move the camera.
2. Movement speed: Move leftward or rightward to set slower or faster the camera is moving.
3. Zoom in/out: Click the buttons or drag on the control bar.
4. Preset positions: Click the buttons to command that the camera go to the preset position.

### 2.2.3 Subtitle Editor

Users can add a custom text to videos.

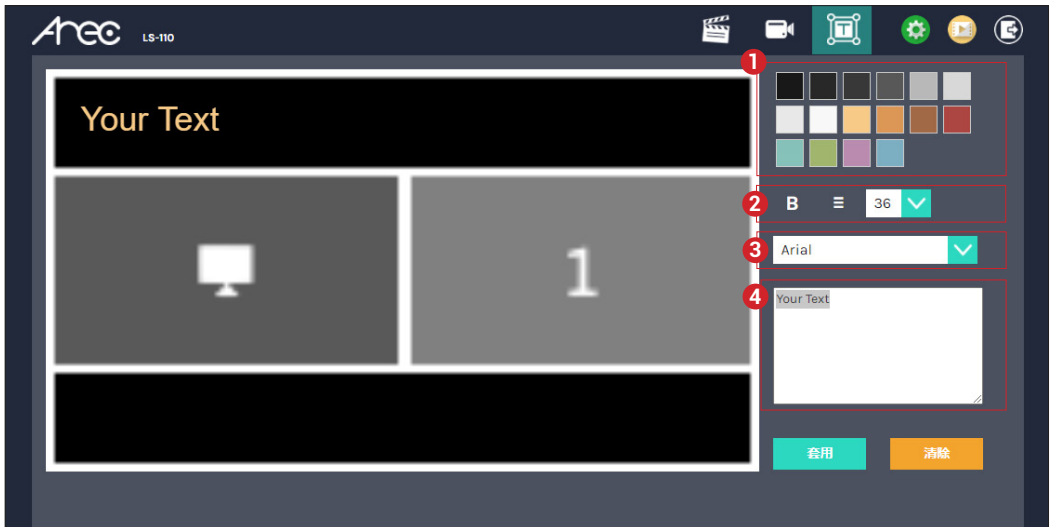

1. Color chart: Click the color block to change the font color.
2. Font format: Adjust the thickness, centering or size of text.
3. Font: Select text font.
4. Text input box: Enter the text you want to put in the video.

## 2.2.4 Recording/Streaming setup

The page provides user to change settings for recording, streaming, content and theme.

Recording	Configure Encoder settings and Bookmark settings for recording.
Streaming	Configure Encoder settings for streaming.
Content	Edit the information of the content that will be recorded.
Theme	Set the overlay files, background images and theme types.

The detail functions, please refer to 1.2 Video



## Chapter 3 Video Manager

The LS-110 embedded Video Manager provides access to recordings produced by LS-110 itself and stored in the internal-storage drive or USB. The video and Snapshot lists are in descending order by the time of occurrence.

Entering the Video Manager webpage via [Administrator][Online Director] by clicking the  button; or log in Video Manager from the initial login page with default username video and password video.

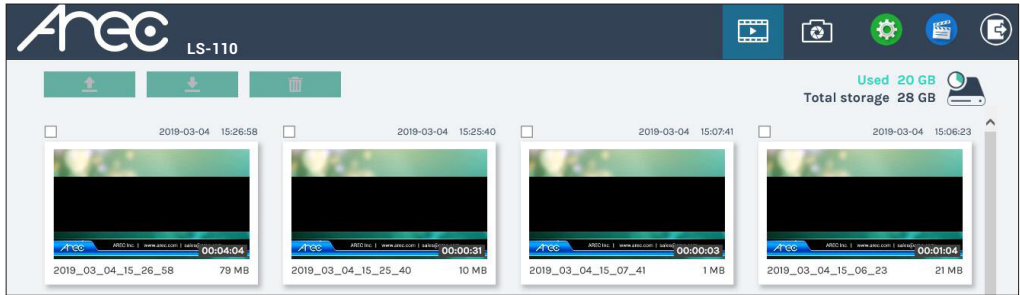

### 3.1 Video Management



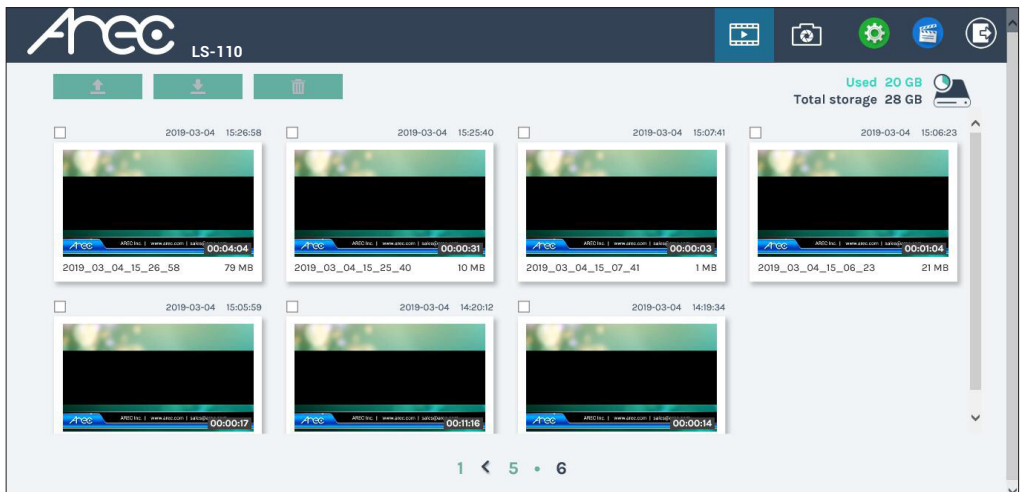

The Video Manager includes the following features:upload, download, delete, playback the recording and edit the recording information.

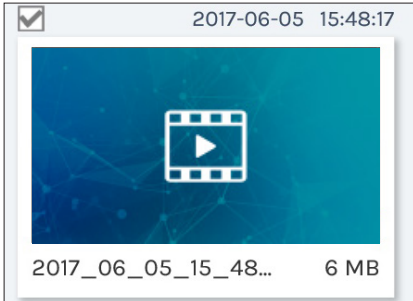

### 3.1.1 Upload the recording

Select the desired recording and click  to add it in the upload queue. The upload destination is pre-configured by system administrator. See [Administrator\ Upload](#) for more details. The LS-110 arranges the upload sequence automatically and indicates the upload status/result on the corresponding recordings. The following indicators are used:



Icon	Upload Status
	The recording package are uploaded successfully.
	The recording upload is failed.
	The recording is in the upload queue.
	The recording is uploading at this moment.

### 3.1.2 Download the recording

Select the desired recording and click . Select Save if offered the choice to Open or to Save the package. The recording packages are downloaded to your computer included mp4 file and dataset file. These are typically saved to the default download location used by your browser.

The recording package may contain more than one .mp4 files if that is recorded in MP4 Mixed video/ Original source recording mode.

To separately download the files in the recording packages, click on the recording thumbnail and access those in the Content information page.

### 3.1.3 Delete the recording

Recording packages can be deleted manually to make room for new recordings.

Select the recording and click . A confirmation dialog box opens asking you to confirm the deletion. Click Confirm to permanently remove the recording packages. The list may not update immediately. Refresh the list by reloading this webpage.

### 3.1.4 Playback the recording

Click on the desired recording and you will be directed to the content information page. Use the player controls at the bottom of the window to watch the video.

There might be more than one files listed under the window if the content is recorded in MP4 Mixed video/ Original source recording mode. Select the video for playback by clicking on the image of the desired one.

The file size being download is shown within the button.

The title used for Mixed video is "Movie", and those for Original source(s) are the name of the corresponding video input(s); by default are Content and Cam 1. To separately download MP4 Mixed video/ Original source files, select the desired file and click Download.

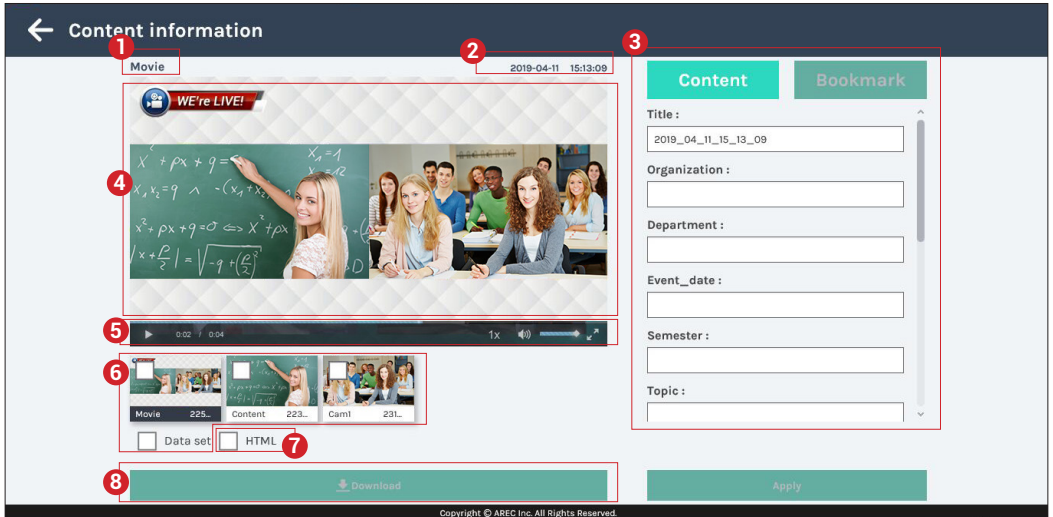

- |   |  |
|---|--|
| <ol style="list-style-type: none"> <li>1. Title of the video file being played</li> <li>2. Recording date and time</li> <li>3. Edit the content fields</li> <li>4. Playback window</li> <li>5. Playback controls</li> </ol> | <ol style="list-style-type: none"> <li>6. Video files and data set (files containing metadata, thumbnail images, and bookmarks.)</li> <li>7. HTML file and thumbnail images</li> <li>8. Download button</li> </ol> |
|---|--|

### 3.1.5 Edit the recording information

If you require to edit the information of a recording, click on the desired recording and you will be directed to the content information page. Replace the existing text or enter new information in the content fields. Click APPLY to save the changes.

### 3.1.6 Edit the bookmark information

If you require to edit the bookmark of a recording, click on the desired recording and you will be directed to the Bookmark page.

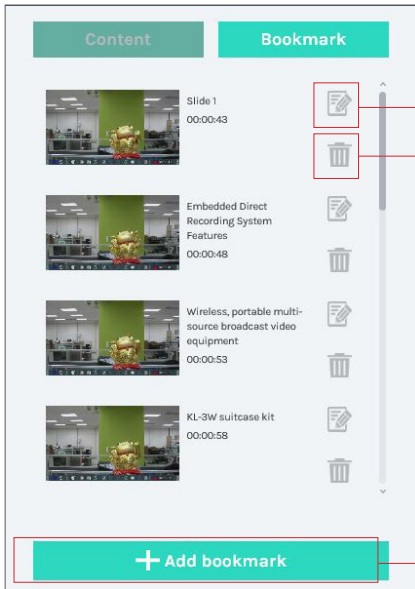

1. Edit the bookmark title.

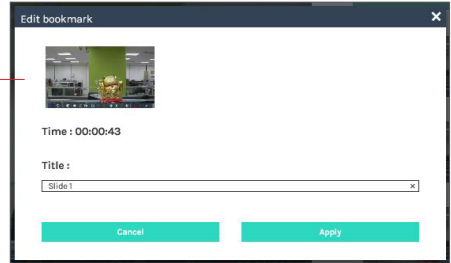

2. Delete the bookmark

3. Add new bookmark with title.

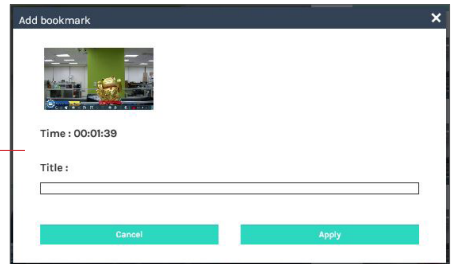

### 3.2 Snapshot Management





The Snapshot Manager includes the following features:upload, download, delete, preview.

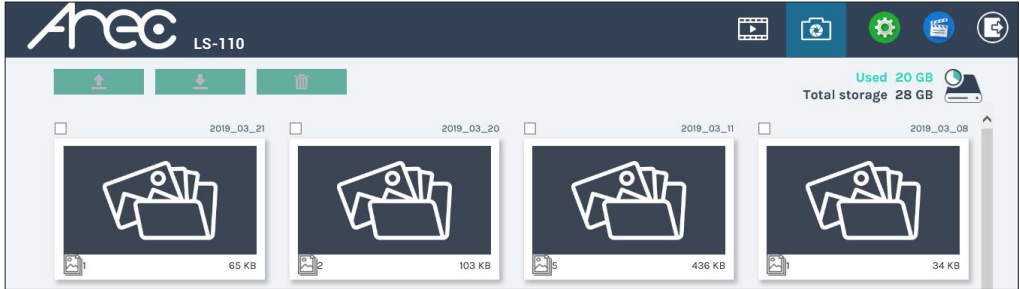

### 3.2.1 Upload the photo

Select the desired photo folder and click  to add it in the upload queue. The upload destination is pre-configured by system administrator. See Administrator\ Upload for more details. The LS-110 arranges the upload sequence automatically and indicates the upload status/result on the corresponding folders. The following indicators are used:



Icon	Upload Status
	The file package are uploaded successfully.
	The file upload is failed.
	The file is in the upload queue.
	The file is uploading at this moment.

### 3.2.2 Download the photo

Select the desired photo folder and click . Select Save if offered the choice to Open or to Save the package. The photo packages are downloaded to your computer. These are typically saved to the default download location used by your browser.

To separately download the photo in the folder, click on the folder thumbnail.

### 3.2.3 Delete the photo

Photo packages can be deleted manually to make room for new photos.

Select the folder and click . A confirmation dialog box opens asking you to confirm the deletion. Click Confirm to permanently remove the photo packages. The list may not update immediately. Refresh the list by reloading this webpage.

### 3.2.4 Preview the photo

Click on the desired photo folder and you will be directed to the photo list page.

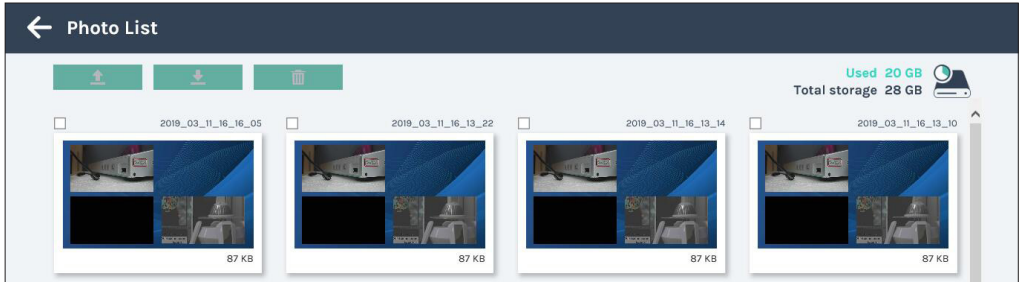



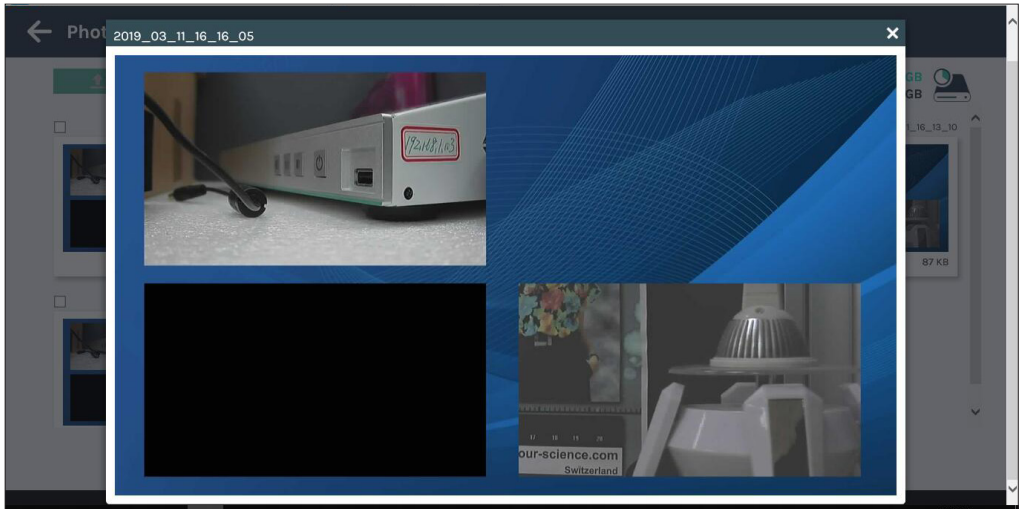









Click on the desired photo to preview the photo.



## Table of On Screen Display Icons

The LS-110 provides HDMI or VGA output for recording monitoring. On screen display there are event icons and sometimes the error operation warnings.



 <p>Disk full</p>	 <p>Disk failure</p>	 <p>Operation is denied</p>	 <p>Live Streaming Error</p>
 <p>Front USB drive mounted</p>	 <p>Front USB in use notification</p>	 <p>Front USB recording error</p>	 <p>Network Error</p>
 <p>Start a scheduled recording</p>	 <p>Cancel a scheduled recording</p>	 <p>Overheat Error</p>	 <p>Time Error</p>

\* When the system date/time is restored to the initial value (2000/1/1 GMT) and has not been synchronized with the NTP server; or the system date/time has not been manually set, this icon "  " will be displayed.

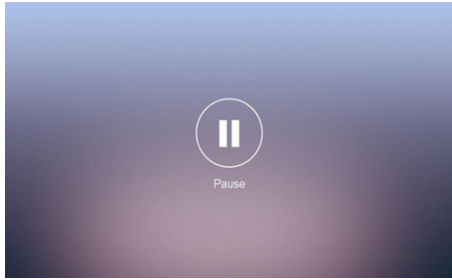

Recording is paused

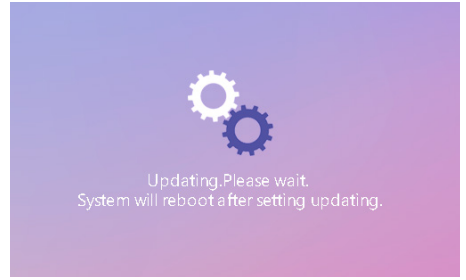

Firmware updating

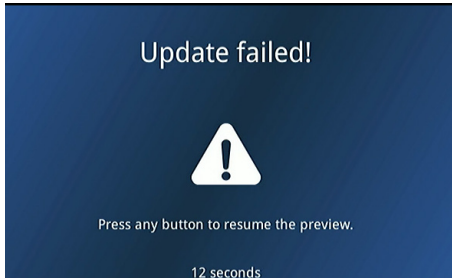

Firmware update failure

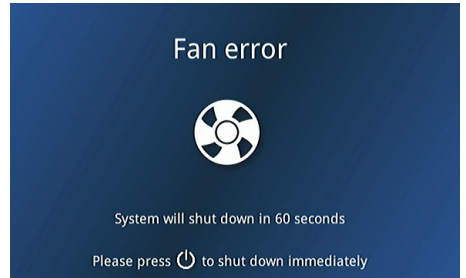

Fan failure

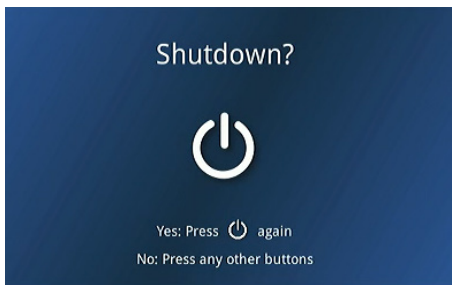

Shutdown confirmation



CPU overheating





---

AREC Inc.© All Rights Reserved 2021. | [www.arec.com](http://www.arec.com)  
All information contained in this document is Proprietary



Made in Taiwan  
Date : 2021.3.1  
Version : 2.20

AREC have the right to change or improve product specifications, without obligation to notify any user.  
Go to [www.arec.com](http://www.arec.com) get the latest information related to the product or additional information.