



4KHDR

HDCP2.2

HDBT
AGE

AVC



PUV-44XPL-AVLC

**4x4 HDMI HDBaseT™ LITE Matrix with AVC
& Audio De-embedding (4K, HDCP2.2, PoH, 60m)
inc. 4x PUV-1710LRX-AVLC Receiver**

OPERATION MANUAL

DISCLAIMERS

The information in this manual has been carefully checked and is believed to be accurate. CYP (UK) Ltd assumes no responsibility for any infringements of patents or other rights of third parties which may result from its use.

CYP (UK) Ltd assumes no responsibility for any inaccuracies that may be contained in this document. CYP (UK) Ltd also makes no commitment to update or to keep current the information contained in this document.

CYP (UK) Ltd reserves the right to make improvements to this document and/or product at any time and without notice.

COPYRIGHT NOTICE

No part of this document may be reproduced, transmitted, transcribed, stored in a retrieval system, or any of its part translated into any language or computer file, in any form or by any means—electronic, mechanical, magnetic, optical, chemical, manual, or otherwise—without express written permission and consent from CYP (UK) Ltd.

© Copyright 2019 by CYP (UK) Ltd.

All Rights Reserved.

Version 1.1

TRADEMARK ACKNOWLEDGMENTS

All products or service names mentioned in this document may be trademarks of the companies with which they are associated.

SAFETY PRECAUTIONS

Please read all instructions before attempting to unpack, install or operate this equipment and before connecting the power supply.

Please keep the following in mind as you unpack and install this equipment:

- Always follow basic safety precautions to reduce the risk of fire, electrical shock and injury to persons.
- To prevent fire or shock hazard, do not expose the unit to rain, moisture or install this product near water.
- Never spill liquid of any kind on or into this product.
- Never push an object of any kind into this product through any openings or empty slots in the unit, as you may damage parts inside the unit.
- Do not attach the power supply cabling to building surfaces.
- Use only the supplied power supply unit (PSU). Do not use the PSU if it is damaged.
- Do not allow anything to rest on the power cabling or allow any weight to be placed upon it or any person walk on it.
- To protect the unit from overheating, do not block any vents or openings in the unit housing that provide ventilation and allow for sufficient space for air to circulate around the unit.

REVISION HISTORY

VERSION NO.	DATE	SUMMARY OF CHANGE
v1.00	16/05/2019	First release
v1.01	09/07/2019	Updated Telnet Commands Table

CONTENTS

1. Introduction	6
2. Applications	6
3. Package Contents	7
4. System Requirements	7
5. Features	8
6. Operation Controls and Functions	9
6.1 Front Panel	9
6.2 Rear Panel	11
6.3 Remote Control	13
6.4 IR Cable Pinouts	14
6.5 RS-232 Pinout and Defaults	14
6.6 OLED Menu	15
6.7 WebGUI Control	19
6.8 Telnet Control	30
6.9 RS-232 and Telnet Commands	31
7. Connection Diagram	40
8. Specifications	41
8.1 Technical Specifications	41
8.2 Video Specifications	42
8.3 Audio Specifications	44
8.4 Cable Specifications	45
8.5 HDBaseT Features	45
9. Acronyms	46

1. INTRODUCTION

This 4x4 HDMI over HDBaseT Matrix with AVLC supports routing and transmission of video (resolutions up to 4K@60Hz w/ HDMI 2.0 & HDCP 2.2) and audio while providing flexible control via IR, RS-232, Telnet or WebGUI. As many as four HD sources may be routed to any of four destinations via single runs of cable up to a distance of 70m. Despite HDBaseT's 10.2Gbps bandwidth limitation, 4K UHD HDMI video sources, up to and including 4K@60Hz (4:4:4, 8-bit) as well as 10/12 bit sources with HDR, are able to be processed and extended by the use of AVLC (Adaptive Visually Lossless Compression) when needed. 3D video is also supported when compatible sources and displays are connected.

This unit supports passing up to 8 channel LPCM digital audio as well as Bitstream and HD Bitstream audio formats. Additionally, four analogue stereo audio outputs are available to provide breakout audio from the associated HDBaseT output (LPCM 2.0 sources only).

The included PoH (Power over HDBaseT) functionality can supply remote power to compatible HDBaseT Receivers, providing greater flexibility in your installations. Control is via front panel buttons with an OLED menu, WebGUI, Telnet, RS-232 or IR remote.

2. APPLICATIONS

- /// Full audio/video matrix systems
- /// Residential AV matrix installations
- /// Commercial AV matrix installations
- /// Security systems
- /// University lecture hall systems
- /// Retail installation system

3. PACKAGE CONTENTS

- /// 1× 4×4 4K UHD+ HDMI over HDBaseT Matrix with AVLC
- /// 1× 24V/6.25A DC Power Adapter
- /// 1× Power Cord
- /// 2× IR Extender Cable
- /// 2× IR Blaster Cable
- /// 1× Remote Control (CR-163)
- /// 1× Shockproof Feet (Set of 4)
- /// 1× Operation Manual

4. SYSTEM REQUIREMENTS

- /// HDMI source equipment such as media players, video game consoles or set-top boxes.
- /// HDMI receiving equipment such as HDTVs, monitors or audio amplifiers.
- /// HDBaseT Receivers equipped with AVLC (Adaptive Visually Lossless Compression) and PoH (PD) support is strongly recommended.
- /// The use of Premium High Speed HDMI cables, and industry standard Cat.6, Cat.6a or Cat.7, is highly recommended.

5. FEATURES

- /// HDMI with HDR & 4K@60Hz support, DVI 1.0 compatible
- /// HDCP 1.x and HDCP 2.2 compliant
- /// Routes four HDMI sources to four displays using four HDBaseT outputs
- /// Supports up to 4K UHD (18Gbps, 4K@60Hz 4:4:4, 8-bit) video input and output
- /// Supports deep colour input and output up to 12-bit
- /// Supports 10-bit and 12-bit HDR (High Dynamic Range) bypass (Output requires AVLC receiver)
- /// Integrated AVLC (Adaptive Visually Lossless Compression) activates when the bandwidth requirements of the source are beyond 10.2Gbps allowing for support of sources up to 18Gbps with no loss of visual quality via compatible HDBaseT Receivers
- /// Supports automatic conversion of 4K@50/60Hz (4:4:4) sources to 4K@50/60Hz (4:2:0) or 1080p50/60 for non-AVLC HDBaseT receivers or if a connected display can't support the original resolution.
Note: 1080p conversion is only available on outputs A & C.
- /// Supported HDBaseT feature set: HD Video & Audio, PoH (PSE), and Control (Bi-directional IR pass through)
- /// 4K signals can be transmitted up to 35m via Cat.5e/6 and up to 40m via Cat.6a/7
- /// Supports pass-through of these standard digital audio formats via HDBaseT: LPCM (up to 8 channels), Bitstream, and HD Bitstream
- /// High quality Digital to Analogue Conversion (DAC) of LPCM 2.0 audio sources for local audio breakout.
- /// Supports generation of OSD banner information
- /// Advanced internal and external EDID management with 4 sets of configurable EDID settings
- /// 1U rack mounted design
- /// Control via front panel controls, Ethernet (Telnet & WebGUI), RS-232, & IR remote

6. OPERATION CONTROLS AND FUNCTIONS

6.1 Front Panel

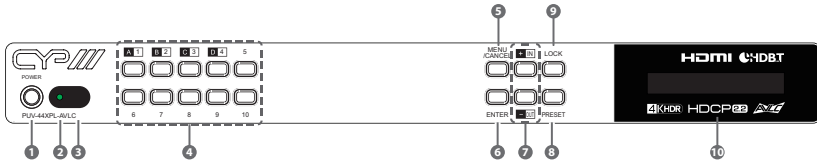

- 1 POWER Button:** Press this button to power the unit on or place it into stand-by mode.

Note: Network functionality and PoH remains active when the unit is in stand-by mode.

- 2 POWER LED:** This LED will illuminate green to indicate the unit is on and receiving power. When the unit is in stand-by mode the LED will illuminate red.
- 3 IR Window:** Accepts IR signals from the included IR remote for control of this unit only.
- 4 OUTPUT A~D/INPUT 1~4/NUMBER 1~10 Buttons:** Press the "OUT" button to enter output selection mode. Next, press the output keys (A~D) of the outputs you wish to route a source to (they will flash to indicate selection). Next, press the "IN" key followed by the input (1~4) you wish to route to the selected outputs. Finally, press "ENTER" to confirm your selection and execute the routing change.

For example, if you wish to display input 1 on outputs A~D then the following sequence of button presses should be performed: **OUT** → **A, B, C, D** → **IN** → **1** → **ENTER**

Note: When directly entering Ethernet address information into the unit all 10 buttons are used to represent the numbers from 0 to 9 (button 10 = 0) to make number entry more streamlined.

- 5 MENU/CANCEL Button:** Press to enter the OLED menu, or to back out from menu items.

Note: For a description of the OLED menu tree, please refer to section 6.6.

- 6 ENTER Button:** Press to confirm a selection or to go deeper into a menu item.

7 +/-IN Button: Inside the OLED menu, this button moves you up within the menu tree. Otherwise, in routing mode, this button allows you to make your input source selection.

-/OUT Button: Inside the OLED menu, this button moves you down within the menu tree. Otherwise, this button activates routing mode and allows you to begin your output destination selections

8 PRESET Button: Press this button to recall saved presets. Press the "Preset" button followed by a number button and the "Enter" button to recall the stored preset assigned to that number. A maximum of 8 presets can be stored in the unit. Presets are created and stored via the WebGUI.

Note: Please refer to section 6.7.1 for advanced preset settings.

9 LOCK Button: Press this button to lock all buttons on the front panel, or press and hold it for 3 seconds to unlock a locked front panel.

Note: The OLED will display an "L" in the upper right corner to indicate the front panel is locked.

10 OLED Window: Displays the unit's menu, settings and information.

6.2 Rear Panel

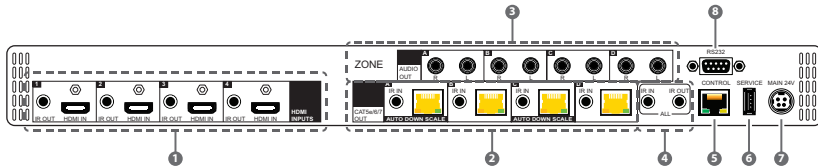

- HDMI IN 1~4 Ports:** Connect to HDMI source equipment such as media players, game consoles, or set-top boxes. DVI sources are supported with the use of an HDMI to DVI adapter.

IR OUT 1~4 Ports: Connect to IR Blasters to transmit IR signals from the other end of the HDBaseT connections to devices within direct line-of-sight of the IR Blaster.

Note: Returning IR signals follow the HDMI signal routing and will also be output via the ALL IR OUT port. IR signals from the connected HDBaseT receivers can also be used to control this matrix remotely.

- CAT5e/6/7 OUT Ports:** Connect to compatible HDBaseT Receivers with Cat.5e/6/7 cables for transmission of all data signals. PoH will also be supplied to a connected compatible PD Receiver.

Note: Output of 4K signals with 10/12-bit HDR (High Dynamic Range) colour requires compatible AVLC receivers. If standard HDBaseT receivers are detected the signal will be automatically converted to 8-bit colour. 4K sources routed to outputs A & C will be automatically scaled to 1080p if the connected display can't support 4K.

IR IN A~D Ports: Connect to IR Extenders to receive IR control signals and extend them to devices connected to the other end of the associated HDBaseT connection. Ensure that the remote being used is within direct line-of-sight of the IR Extender.

- ZONE AUDIO OUT A~D Ports:** Four sets of analogue stereo audio outputs. Connect to powered speakers or an amplifier for analogue stereo audio output from each associated HDBaseT output. (LPCM 2.0 sources only).
- IR IN (ALL) Port:** Connect an IR Extender to this port for IR signal reception. All IR signals received will be broadcast by all IR blasters connected to the matrix and to all connected HDBaseT receivers. Please ensure that the remote being used is within direct line-of-sight of the IR Extender.

IR OUT (ALL) Port: Connect an IR Blaster to this port to broadcast IR

signals. All IR signals received by any IR Extenders connected to the matrix or HDBaseT receivers will be broadcast. Please place the IR Blaster in direct line-of-sight of the equipment to be controlled.

- 5 **CONTROL Port:** Connect directly, or through a network switch, to your PC/laptop to control the unit via Telnet/WebGUI.
- 6 **SERVICE Port:** This port is reserved for firmware update use only.
- 7 **MAIN 24V Port:** Plug the 24V DC power adapter into this port and connect it to an AC wall outlet for power.
- 8 **RS232 Port:** Connect directly to a PC, laptop, or other serial control device to send RS-232 commands to control the unit.

6.3 Remote Control

- 1 **POWER Button:** Press to power the unit on or place it into stand-by mode.
- 2 **LOCK Button:** Press to lock/unlock the front panel of the matrix unit.
- 3 **MUTE Button:** No function.
- 4 **IN 1~4, OUT A~D & PATTERN Buttons:**

[Local matrix control]: When controlling the unit directly, input and output selection behaves the same as the front panel buttons with the “Pattern” button acting as an additional test pattern source.

Note: Refer to section 6.1 for more details.

[Zone A/V Pairing]: When controlling the unit via an HDBaseT receiver in a remote location, pressing buttons 1~10 will switch to the A/V source assigned to the number depending on your current zone. These assignments are configured via the WebGUI.

Note: Refer to section 6.7.2 for more details.

- 5 **MENU/CANCEL Button:** Press the “MENU/CANCEL” button to enter the OLED menu, or to back out from menu items.
- 6 **PRESET Button:** Recall matrix presets. Press the “Preset” button followed by a number button to recall the stored preset assigned to that number. The presets are configured within the WebGUI.
- 7 **+/IN Button:** Within the menu, this button moves you up within the menu tree. Otherwise, in routing mode, this button allows you to make your input source selection.
-/OUT: Within the menu, this button moves you down within the menu tree. Otherwise, this button starts routing mode and allows you to begin your output destination selections.
◀/VOL- & ▶/VOL+ Button: No function.
- 8 **ENTER:** Press this button to confirm selections.

Note: This remote control is designed for the full family of matrix products. Some functions are not available on all units.

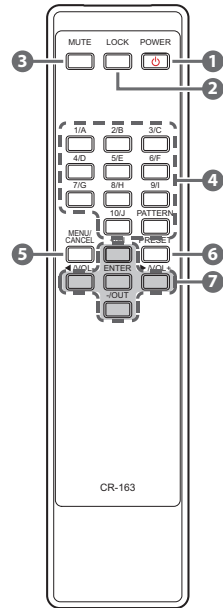

6.4 IR Cable Pinouts

IR Blaster Cable

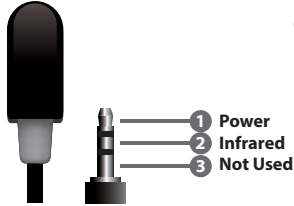

IR Extender Cable

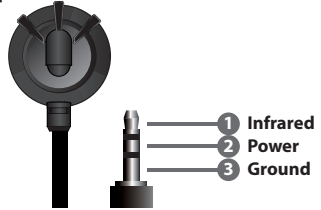

6.5 RS-232 Pinout and Defaults

Serial Port Default Settings	
Baud Rate	19200
Data Bits	8
Parity Bits	None
Stop Bits	1
Flow Control	None

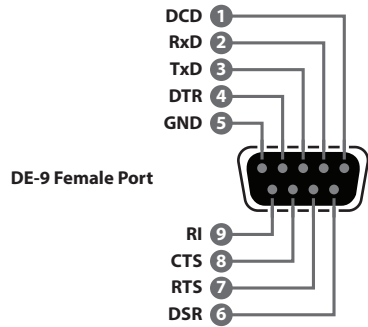

6.6 OLED Menu

All basic functions of this unit can be controlled by using the front panel's OLED menu which is activated by pressing the MENU/CANCEL button on the front of the unit. Use the + (PLUS), – (MINUS), and ENTER buttons to navigate the menu. Press the MENU/CANCEL button to back out from any menu item and then press it again to close the menu. The number buttons may also be used to quickly navigate the numbered menu items.

When not in the menu, the model name and IP address of the unit will be displayed. Additional networking information (netmask and gateway) can be displayed by repeatedly pressing the “+” or “–” buttons on the front panel or remote control.

MAIN MENU
1-EDID
2-Network
3-Factory Default
4-Firmware
5-Miscellaneous

The individual functions of the OLED menu will be introduced in the following section. Items marked in **BOLD** are the factory default settings.

1-EDID	
2ND LEVEL	3RD LEVEL
1-EDID Mode	ALL
	Independent
2-EDID Select (All or 1~4)	1-FHD/2CH
	2-FHD/Mch
	3-UHD/2ch
	4-UHD/Mch
	5-UHD+/2ch
	6-UHD+/Mch
	7-Sink A
	8-Sink B
	9-Sink C
	10-Sink D
	11-User 1
	12-User 2
	13-User 3
	14-User 4

- 1) **EDID Mode:** Select the EDID mode of the unit between All or Independent. "All" mode assigns the same EDID to all inputs. "Independent" mode allows each input to have a different EDID.
- 2) **EDID Select:** In "All" mode, select the EDID to use with all inputs. In "Independent" mode, press the numbered button of the input to adjust, and then select the EDID to use with that input. After making a selection press the "Enter" button to save the change.

2-NETWORK	
2ND LEVEL	3RD LEVEL
1-Link Status	[Current link status]
2-IP Address	[Unit's current IP address]
3-Subnet Mask	[Unit's current subnet mask]
4-Gateway Address	[Unit's current gateway address]
5-MAC Address	[Unit's MAC address]
6-DHCP Mode	On
	OFF

- 1) **Link Status:** Displays the current Ethernet link status.
- 2) **IP Address:** When DHCP is off, the IP address can be set here. The digit currently being edited will flash. The editable digit can be changed by using the +/- buttons. Press a front panel number button to enter a new number. Press the "Enter" button to store the current number segment and move to the next segment.
Note: The unit's default static IP address is 192.168.1.50.
- 3) **Subnet Mask:** When DHCP is off, the subnet mask can be set here. The digit currently being edited will flash. The editable digit can be changed by using the +/- buttons. Press a front panel number button to enter a new number. Press the "Enter" button to store the current number segment and move to the next segment.
- 4) **Gateway Address:** When DHCP is off, the gateway address can be set here. The digit currently being edited will flash. The editable digit can be changed by using the +/- buttons. Press a front panel number button to enter a new number. Press the "Enter" button to store the current number segment and move to the next segment.
- 5) **MAC Address:** Displays the unit's MAC address.
- 6) **DHCP Mode:** Enable or disable DHCP mode. When enabled, all IP address information will be assigned automatically by the local DHCP server. When disabled, the IP address must be set manually.

Note: When DHCP is enabled, the IP address, subnet mask, and gateway address can not be edited.

3-FACTORY DEFAULT	
2ND LEVEL	3RD LEVEL
Factory Reset?	Yes
	NO

- 1) **Factory Reset:** Selecting “Yes” will perform a factory reset and return the unit to its factory default state. After the reset is complete, the unit will reboot automatically.

4-FIRMWARE	
2ND LEVEL	3RD LEVEL
1-Version	[Unit’s current firmware version]
Factory Reset?	Yes
	NO

- 1) **Version:** Displays the unit’s current firmware version.
- 2) **Update:** Provides a way to update the unit’s firmware. To begin the firmware update process, select “Yes” followed by pressing the “Enter” button. Next, insert a USB thumb drive, with a valid firmware file (*.bin format) in the root directory, into the unit’s USB service port and the update will begin automatically. The unit will automatically reboot to complete the update process.

5-MISCELLANEOUS	
2ND LEVEL	3RD LEVEL
1-IR Remote Channel	0 ~ 15 [0]
2-Discrete IR Address	[Displays current status]
3-System Baud Rate	[Displays current baud rate]

- 1) **IR Remote Channel:** Select the IR remote channel that the unit will accept signals on.
- 2) **Discrete IR Address:** Displays the current discrete IR address state.
- 3) **System Baud Rate:** Displays the unit’s current serial control baud rate.

6.7 WebGUI Control

Device Discovery

Please obtain the “Device Discovery” software from your authorised dealer and save it in a directory where you can easily find it.

Connect the unit and your PC/Laptop to the same active network and execute the “Device Discovery” software. Click on “Find Devices on Network” and a list of devices connected to the local network will show up indicating their current IP address.

Note: The unit’s default IP address is 192.168.1.50.

Find Devices on Network			
Product Name	Description	IP Address	MAC Address

By clicking on one of the listed devices you will be presented with the network details of that particular device.

Product ID	
Product Name	
MAC Address	00:00:00:00:00:00
IP Address	<input type="text"/>
Subnet Mask	<input type="text"/>
Gateway IP	<input type="text"/>
DNS	<input type="text"/>
IP Mode	Static
Web GUI Port	Static
Telnet Port	0
S / N	
Firmware Version	
Hardware Version	
Description	
Web GUI	Web GUI
<input type="button" value="Save"/> <input type="button" value="Reboot"/>	

- 1) IP Mode:** If you choose, you can alter the static IP network settings for the device, or switch the unit into DHCP mode to automatically obtain proper network settings from a local DHCP server. To switch to DHCP mode, please select DHCP from the IP mode drop-down, then click “Save” followed by “Reboot”.
- 2) WebGUI Hotkey:** Once you are satisfied with the network settings, you may use them to connect via Telnet or WebGUI. The network information window provides a convenient link to launch the WebGUI directly.

WebGUI Overview

After connecting to the WebGUI's address in a web browser, a login prompt will appear. Please enter the appropriate user name and password then click "Sign In" to log in.

Note: The default user name and password is "admin".

On the left side of the browser you will see the following menu tabs where all primary functions of the unit are controllable via the built in WebGUI. The individual functions will be introduced in the following sections.

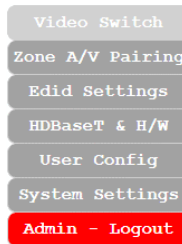

Clicking the red "Logout" tab will automatically log the currently connected user out of the WebGUI and return to login page.

6.7.1 Video Switch Tab

This tab provides control over video routing, input and output naming, test pattern configuration, and preset storage/recall.

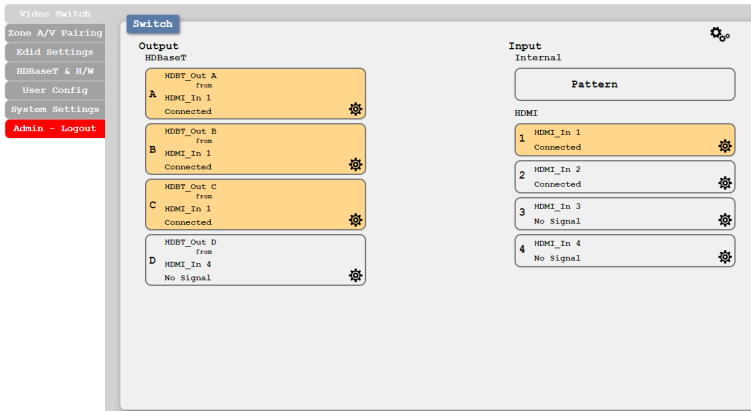

- 1) **Output and Input Routing:** To begin assigning a new video route, please click the button of the HDBaseT output you wish to send video to and then click on the button of the preferred HDMI input port or Pattern. If desired, you may select more than one output prior to selecting the input. As you select each button they will change their colour to orange. The new route will become active immediately and the routing information displayed on the buttons will change accordingly.

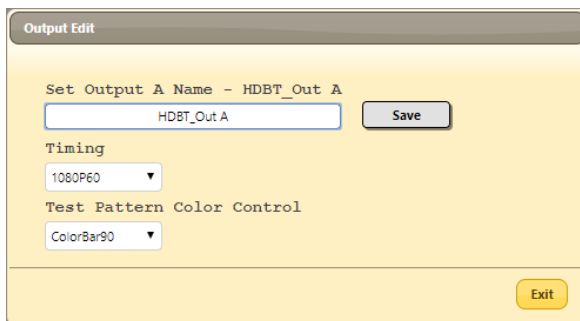

- 2) **Output Edit:** Clicking on the “Edit” icon (⚙️) for an output provides a way to change the name of the output. It also provides control over

the test pattern resolution and style used when the “Pattern” source is routed to the output. Click the “Save” button to confirm a name change.

Note: Blank spaces are not allowed in names.

- **Timing:** Test patterns can be generated on any HDBaseT output at the following standard resolutions with a variety of refresh rates: 480i/p, 576i/p, 720p, 1080p, 4K.

Note: Test pattern output does not enable HDCP.

- **Test Pattern Colour Control:** The test pattern type can be changed to any one of 15 different options. The patterns include full screen colours as well as a selection of other basic patterns.

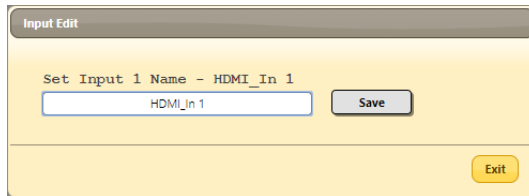

- Input Edit:** Clicking on the “Edit” icon (⚙️) for an input allows editing of the name for that input. Click the “Save” button to confirm a name change.

Note: Blank spaces are not allowed in names.

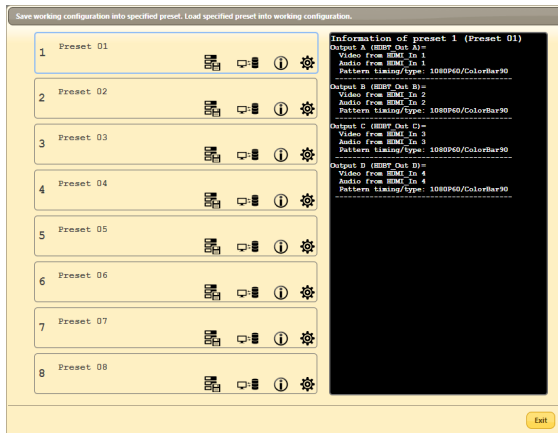

4) **Preset Settings:** This matrix can store up to eight routing presets. Presets can be utilised to store multiple different routing states in advance for rapid, hassle-free, recall. To store, recall or view a preset, click the “Preset” icon (⚙️) in the upper right corner of the tab to open the Preset configuration window.

- **Save:** Click the “Save” icon (💾) next to the preferred Preset to store the current matrix configuration into that preset. After updating the preset, the information box to the right will show the new routing details.
- **Load:** When you wish to load a previously stored setting, please click the “Load” icon (📂) associated with the Preset you wish to load. The Preset will load immediately upon clicking the icon.
- **Information:** Click the “Information” icon (ℹ️) next to the preferred Preset to view the current contents of the specified preset in the information box to the right.
- **Rename:** Click the “Edit” icon (✎️) to open the rename sub window. After entering a new name, click the “Save” button to confirm the name change.

Note: Blank spaces are not allowed in names.

6.7.2 Zone A/V Pairing Tab

The Zone A/V Pairing function allows the end user to control the matrix, using the supplied remote control, in a customised manner while in remote rooms (zones) containing an HDBaseT receiver and IR extender.

Each zone can have a different set of sources assigned to the buttons on the remote control for easy switching. The video and audio routing selections for each of the four HDBaseT outputs need to be set up via the WebGUI in advance.

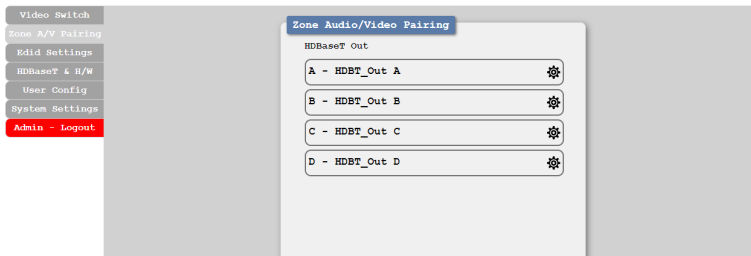

After configuring the button pairing for a zone, the user can change the routing in whichever zone they are currently located simply by pressing a number key on the remote control. The discrete zone pairings can also be activated from within the WebGUI or by using Telnet/RS-232 commands.

Button No.	Video
1	HDMI In 1(HDMI_In 1) ▼
2	HDMI In 2(HDMI_In 2) ▼
3	HDMI In 3(HDMI_In 3) ▼
4	HDMI In 4(HDMI_In 4) ▼
5	HDMI In 1(HDMI_In 1) ▼
6	HDMI In 2(HDMI_In 2) ▼
7	HDMI In 3(HDMI_In 3) ▼
8	HDMI In 4(HDMI_In 4) ▼
9	HDMI In 1(HDMI_In 1) ▼
10	HDMI In 2(HDMI_In 2) ▼

- 1) Video and Audio Pairing Edit:** Click the “Edit” icon (⚙️) in the output zone you wish to configure and then select the video source to associate with each IR remote button when used within that zone. Once you have completed your selections press “Save”.

HDBastT Out A A/V Pairing selection

1

2

3

4

5

6

7

8

9

10

2) **Quick Button Selection:** To activate an audio/video pairing from the WebGUI, select the preferred output zone (A~D) to launch its selection window. The numbers 1~10 correspond to the keys on the remote control and hovering the mouse over each button will reveal the routing currently associated with it.

6.7.3 EDID Settings Tab

This matrix provides the option of six standard EDIDs, four sink sourced EDIDs and four customer uploaded EDIDs that can be assigned to each input port individually. The names of the four customer uploaded EDIDs can be changed if desired.

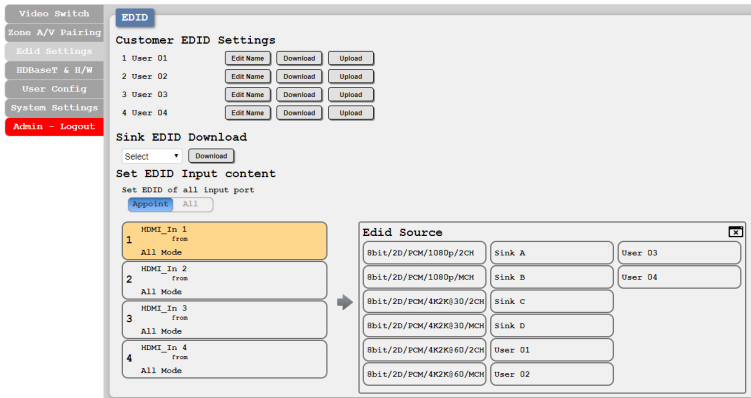

1) Customer EDID Settings

- **Edit Name:** Click the “Edit Name” button next to the Customer EDID you wish to rename. Click the “Save” button to confirm the change.
- **Download:** To save an existing Customer EDID to your local PC, press the “Download” button next to the Customer EDID you would like to save. An EDID Download sub-window will appear, allowing you to save the EDID file (*.bin format) to your local PC. Select a save location and click the “Download” button in the sub window, and the file will be transferred to your PC.
- **Upload:** To upload a Customer EDID into the unit, please click the “Upload” button next to the Customer EDID you would like to replace. An EDID Upload sub-window will appear, allowing you to select and upload the new EDID file (*.bin format) from your

local PC. Once the correct file has been selected, click the “Upload” button in the sub-window, and the file will be transferred to the unit.

- 2) **Sink EDID Download:** To save the EDID of a connected sink to your local PC, select the sink from the dropdown and then press the “Download” button. An EDID Download sub-window will appear, allowing you to save the EDID file (*.bin format) to your local PC.
- 3) **Set EDID Input Content:** The Set EDID Input Content section allows for the assignment of an EDID to each individual input port, or to all inputs at once. Click the selection bar to toggle between “Appoint” (individual assignment), or “All” inputs.

This unit provides the following 6 default EDIDs:

Unit's Default EDIDs		
FHD/2CH	1920×1080p@60Hz (148MHz) & 8 bit colour	LPCM 2.0
FHD/MCH	1920×1080p@60Hz (148MHz) & 8 bit colour	LPCM 7.1 & Bitstream
UHD/2CH	3840×2160p@30Hz (297MHz) & Deep Colour (8/10/12-bit)	LPCM 2.0
UHD/MCH	3840×2160p@30Hz (297MHz) & Deep Colour (8/10/12-bit)	LPCM 7.1 & Bitstream
UHD+/2CH	3840×2160p@60Hz (594MHz) & Deep Colour (8/10/12-bit)	LPCM 2.0
UHD+/MCH	3840×2160p@60Hz (594MHz) & Deep Colour (8/10/12-bit)	LPCM 7.1 & Bitstream

Note: In some rare cases it is possible for custom or external EDIDs to cause compatibility issues with certain sources. If this happens, it is recommended to switch to one of the 6 default EDIDs for maximum compatibility.

6.7.4 HDBaseT & H/W Tab

This tab provides information concerning the temperature inside the unit, the connection status of all outputs, and the HDBaseT firmware versions used by the unit and any connected receivers.

Port	Local FwID	Remote FwID
	V5010 Tx v3136.1	V5010 Rx v3136.1
B	V5010 Tx v3136.1	-
C	V5010 Tx v3136.1	-
D	V5010 Tx v3136.1	-

- 1) **Hardware Monitor:** Displays the current temperature inside the unit.
- 2) **HDBaseT Information:** Displays the HDBaseT firmware used by the unit and all connected receivers. The colour of the “Port” column indicates the status of the connection between each output and its associated receiver. Green indicates a good and stable connection, white indicates no detected receiver, and red indicates excessive errors or a communication fault.

6.7.5 User Config Tab

The WebGUI username and password are set on this page. Two management levels are available: “Administrator” and “General User”. The administrator username (“admin”) cannot be changed.

The “Administrator” user has access to change all settings. The “General User” is not permitted to access or change information on the EDID Settings or System Settings pages.

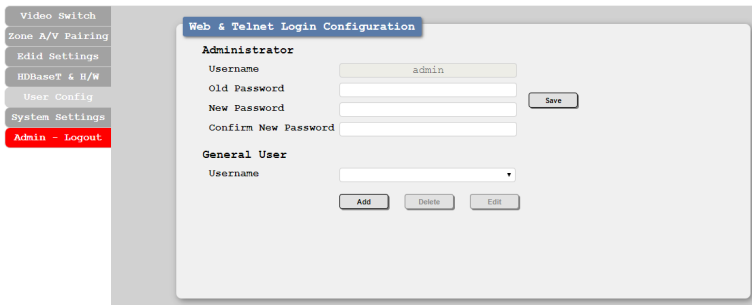

6.7.6 System Settings Tab

This tab provides system configuration options including turning the power on/off, changing the network settings, downloading/restoring saved system configurations, resetting the system to factory defaults and updating the firmware.

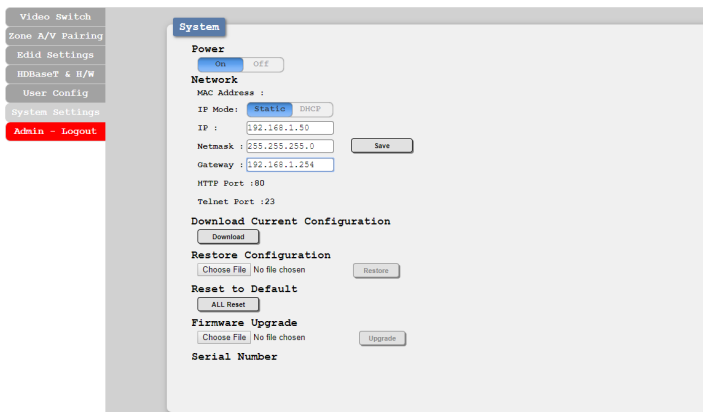

- 1) **Power:** Press this switch to toggle the unit's power between ON and OFF (standby mode).

Note: While in standby mode the unit's WebGUI, Telnet and RS-232 controls are still active.

- 2) **Network:** The unit's IP mode may be switched between Static IP or DHCP. In Static IP mode the IP, netmask and gateway addresses may be manually set. When in DHCP mode, the unit will attempt to connect to a local DHCP server and obtain IP, netmask and gateway addresses automatically. Please press "Save" after making any changes to the IP configuration or mode.

Note: The unit's default IP address is 192.168.1.50. If the IP address is changed then the IP address required for WebGUI and Telnet access will also change accordingly.

- 3) **Download Current Configuration:** Click the "Download" button to save the current system configuration to your local PC. The current system configuration will be saved as an XML file.
- 4) **Restore Configuration:** To restore a previously saved system configuration, click the "Choose File" button to locate the saved XML file, then click the "Restore" button.
- 5) **Reset to Default:** Press the "ALL Reset" button to reset the unit to its factory default state. After the reset is complete, the unit will reboot automatically.
- 6) **Firmware Upgrade:** To update the unit's firmware, click the "Choose File" button to open the file selection window and then select the firmware update file (*.bin format) located on your local PC. After selecting the file, click the "Upgrade" button to begin the firmware update process. The unit will automatically reboot to complete the update process.
- 7) **Serial Number:** Displays the unit's serial number.

6.8 Telnet Control

Before attempting to use Telnet control, please ensure that both the unit and the PC are connected to the same active networks.

Unit's Default EDIDs	
Windows 7	Click Start , type "cmd" in the search field, and press Enter .
Windows XP	Click Start > Run , type "cmd", and press Enter .
Mac OS X	Click Go > Applications > Utilities > Terminal .

Once in the Command Line Interface (CLI) type "**telnet**" followed by the IP address of the unit (and the port number if it is non-standard) and then hit "**Enter**". This will connect us to the unit we wish to control.

```
Microsoft Windows [Version 6.1.7601]
Copyright (c) 2009 Microsoft Corporation. All rights reserved.

C:\Users\Administrator>telnet 192.168.1.50 23
```

Note 1: If the IP address is changed then the IP address required for Telnet access will also change accordingly.

Note 2: The default IP address is 192.168.1.50.

6.9 RS-232 and Telnet Commands

COMMAND	DESCRIPTION AND PARAMETERS
EDID All=EdidSetNumber	Set EDID of all input port =Specified EDID set number.
EDID HDMI_In M=EdidSetNumber	Set specified HDMI input port M=Specified EDID set number.
EDID M Name="NameString"	Set verbose name of specified EDID slot M. M =11~14.
HDBT_Out M VideoSrc=XXX	Video source of HDBaseT Tx out A~D. M=A~D(Support multiple selection). Available XXX: HDMI_In n, n=1~4
HDBT_Out M VideoSrc=Default	Reset Video source of HDBT Tx out A~D to factory default. M=A~D(Support multiple selection).
HDBT_Out M Status	Display HDBT A~D status & properties including Aud/Vid matrix. M=A~D(Support multiple selection).
HDBT_Out M Name="NameString"	Setup HDBT A~D verbose name. M=A~D(Only support single selection).
HDBT_Out M OSDString="OSDString"	Setup HDBT A~D OSD string. M=A~D(Only support single selection).
HDBT_Out M OSDArea=Location	Setup HDBT A~D OSD area. M=A~D(Only support single selection). Location="TopLeft", "TopCenter", "TopRight", "MiddleLeft", "MiddleCenter", "MiddleRight", "BottomLeft", "BottomCenter", "BottomRight"

COMMAND	DESCRIPTION AND PARAMETERS
HDBT_Out M OSDTimeout=Second	Setup HDBT A~D OSD timeout. M=A~D(Only support single selection). Second=0~60sec., 0:OSD always On
HDBT_Out M OSDRow1=State	Setup HDBT A~D OSD Banner row_1 status M=A~D(Only support single selection). State="On", "Off"
HDBT_Out M OSDRow2=State	Setup HDBT A~D OSD Banner row_2 status M=A~D(Only support single selection). State="On" "Off"
HDBT_Out M OSDRow3=State	Setup HDBT A~D OSD Banner row_3 status M=A~D(Only support single selection). State="On", "Off"
HDBT_Out M POE=State	Setup HDBT A~D POE State. M=A~D(Only support single selection). State="On", "Off"
HDBT_Out M AVLC=State	Setup HDBT A~D VLC State. M=A~D(Only support single selection). State="STD", "HQ"
HDBT_Out M CECSend= 0xxx 0xyy 0zzz	Send HDBT A~D CEC message. M=A~D(Support multiple selection). Xx yy zz is hex format.
HDBT_Out M DownScale=State	Setup HDBT A~D DownScale State. M=A~D(Only support single selection). State="On", "Auto", "Off"

COMMAND	DESCRIPTION AND PARAMETERS
HDBT_Out M PatternTiming= PatternTiming	Setup HDBT A~D Pattern timing M=A~D(Only support single selection). 480p 480i 576p 576i 720p60 720p50 1080p24 1080p25 1080p30 720p25 720p30 1080p60 1080p50 720p100 720p120 1080p120 1080p100 2160p24 2160p25 2160p30 2160p24DCI 2160p25DCI 2160p30DCI 2160p50 2160p60
HDMI_In M Status	Display HDMI In 1~4 status. M=1~4(Support multiple selection).
HDMI_In M Name="NameString"	Setup HDMI In 1~4 verbose name. M=1~4(Only support single selection).

COMMAND	DESCRIPTION AND PARAMETERS
HDMI_In M CECSend=0xxx 0xyy 0xzz	Setup HDMI In 1~4 CEC message. M=1~4(Support multiple selection). Xx yy zz is hex format.
HDMI_In M Hdcp=State	Setup HDMI In 1~4 Hdcp support. M=1~4(Only support single selection). State="On","Off"
IRgenerator code=0xxx 0xyy 0xzz	Send IR code Xx yy zz is hex format.
IRgenerator format=M0	IR code format M0=CYP ,cypress IR format. M0=Pronto ,Pronto IR format
IR_Route HDBT_Out M0 M1 M2	Setup IR source of HDBT Rx end IR out jack. M0=Output port index. M0=A~D (Support multiple selection) M1=Route operation. Available M1: Add: Add M2 input source to HDBT_Out. Del: Delete M2 input source from HDBT_Out. M2=Input source. Available M2: IR_InAll: IR In all input jack. Generator: Internal IR encoder.
IR_Route HDBT_Out M0 Show	Print current IR source of HDBT Rx end IR out jack. M0=Output port index. M0=A~D (Support multiple selection)

COMMAND	DESCRIPTION AND PARAMETERS
IR_Route IR_Out M0 M1 M2	Setup IR source of IR_Out jack aside of each HDMI In connector. M0=Output port index. M0=1~4 (Support multiple selection) M1=Route operation. Available M1: Add: Add M2 input source to IR_Out. Del: Delete M2 input source from IR_Out. M2=Input source. Available M2: IR_InAll: IR In all input jack. Generator: Internal IR encoder.
IR_Route IR_Out M0 Show	Print current IR source of IR_Out jack aside of each HDMI In connector. M0=Output port index. M0=1~4 (Support multiple selection)
Uart M BaudRate=State	Set HDBT A~D UART Baud rate configure. M=A~D(Support multiple selection). State= "2400", "4800", "7200", "9600", "14400", "19200", "38400", "57600", "115200"
Uart M DataBit=State	Set HDBT A~D Data Bit format. M=A~D(Support multiple selection). State= "5", "6", "7", "8"
Uart M Parity=State	Set HDBT A~D Parity format. M=A~D(Support multiple selection). State= "None", "Odd", "Even"
Uart M UartSend="data string"	Send out HDBT A~D Uart data string. M=A~D(Only Support single selection).

COMMAND	DESCRIPTION AND PARAMETERS
Uart M Status	Uart Format status M=A~D(Support multiple selection).
ZoneAvPair HDBT_Out M Slot N VideoSrc=XXX	Setup HDBT_Out zone side audio/video pairing storage slot N video source. M=A~D(Only support single selection). N=1~11 (Support multiple selection). Available XXX: HDMI_In n, n=1~4 (Not available on slot 11) Pattern
ZoneAvPair HDBT_Out M Slot N PatternTiming=XXX	Same parameter as HDBT_Out M PatternTiming=PatternTiming
ZoneAvPair HDBT_Out M Slot N PatternType=XXX	Same parameter as HDBT_Out M PatternType=PatternType
ZoneAvPair HDBT_Out M Slot N Load	Load slot N of HDBT_Out zone side audio/video pairing storage. M=A~D(Only support single selection). N=1~11 (Support multiple selection).
SETIP <IP> <SubNet> <GW>	Setting IP.SubNet.GateWay(Static IP)
RSTIP	IP Configuration Was Reset To Factory Defaults(DHCP)
IPCONFIG	Display the current IP config
P0	Power Off with network

COMMAND	DESCRIPTION AND PARAMETERS
P1	Power On
P2	Power Off all
P?	Display Power State
PRESET Save M	Save current A/V routing. M=1~8.
PRESET Load M	Recall current A/V routing. M=1~8.
PRESET Show [M]	List current stored A/V preset. M=1~8. If M is omitted, list all A/V preset.
PRESET name M="NameString"	Set verbose name of specified preset slot M.
FactoryDefault	Reset all configuration to factory default.
?	Display all available commands(Except hidden commands)
Help	Display all available commands(Except hidden commands)
Ver	Show firmware version
DiscreteIR Address=M0	Select IR channel. Also means to select Custom code M0= *)."Off" :Turn off Discrete IR feature *)."?" :Show current Channel setting status *). Hexadecimal or decimal value. Set Address value: Can't be over 0xFFFF(decimal : 65535). If typing Hexadecimal, need to add 0x, example: 0x3456

COMMAND	DESCRIPTION AND PARAMETERS
IrRemote Channel=M0	<p>Select IR channel. Also means to select Custom code</p> <p>M0=</p> <p>*):'0'~'15':Select Channel number. Start from 0 is to match the dip switch on the remote and binary format.</p> <p>*):'?' :Show current Channel setting status</p> <p>Each Channel matching to NEC IR's Custom code:</p> <p>0x00FF /* Channel 0*/ 0x00DF /* Channel 1*/ 0x00BF /* Channel 2*/ 0x009F /* Channel 3*/ 0x00F7 /* Channel 4*/ 0x00D7 /* Channel 5*/ 0x00B7 /* Channel 6*/ 0x0097 /* Channel 7*/ 0x00FB /* Channel 8*/ 0x00DB /* Channel 9*/ 0x00BB /* Channel 10 */ 0x009B /* Channel 11 */ 0x00F3 /* Channel 12 */ 0x00D3 /* Channel 13 */ 0x00B3 /* Channel 14 */ 0x0093 /* Channel 15 */</p>
SaveMuteSetting On	Accept saving Audio mute status
SaveMuteSetting Off	Do not accept saving Audio mute status, Every time power on will be Unmute status
SaveMuteSetting ?	Show current Audio mute status
? <any Command>	Display instruction of that command

COMMAND	DESCRIPTION AND PARAMETERS
SetBaudRate mode	Set system UART Baud rate configure. mode= "2400", "4800","7200", "9600", "14400", "19200", "38400", "57600", "115200"
SetBaudRate ?	Query system UART Baud rate configure.

*Note: Commands will not be executed unless followed by a carriage return.
Commands are not case-sensitive.*

7. CONNECTION DIAGRAM

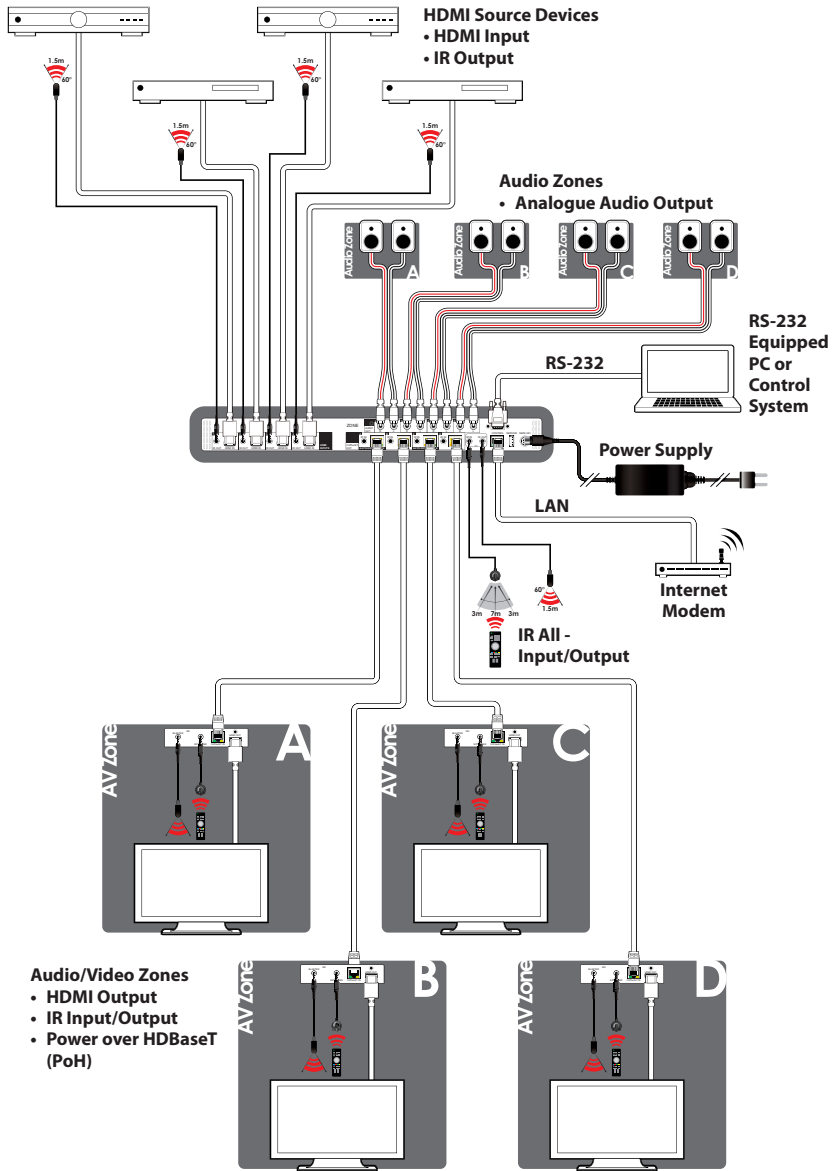

8. SPECIFICATIONS

8.1 Technical Specifications

HDMI Bandwidth	18Gbps
HDBaseT Bandwidth	10.2Gbps
Input Ports	4×HDMI (Type-A)
Output Port	4×HDBaseT (RJ-45) 4×Stereo Audio (RCA Pairs)
Pass-through Ports	5×IR Extender (3.5mm) 5×IR Blaster (3.5mm)
Control Ports	1×RS-232 (DE-9) 1×IP Control (RJ-45)
Service Port	1×USB 2.0 (Type A)
IR Frequency	30 – 50kHz (30 – 60kHz under ideal conditions)
Baud Rate	19200
Power Supply	24V/6.25A DC (US/EU standards, CE/FCC/UL certified)
ESD Protection (HBM)	±8kV (Air Discharge) ±4kV (Contact Discharge)
Dimensions (W×H×D)	438mm×44mm×270mm [Case Only] 482mm×49mm×279mm [All Inclusive]
Weight	3.642kg
Chassis Material	Metal (Steel)
Chassis Colour	Black
Operating Temperature	0°C – 40°C/32°F – 104°F
Storage Temperature	-20°C – 60°C/-4°F – 140°F
Relative Humidity	20 – 90% RH (Non-condensing)
Power Consumption	92W

8.2 Video Specifications

Supported Resolutions (Hz)	Input	Output
	HDMI	HDBaseT
720×400p@70/85	✓	✓
640×480p@60/72/75/85	✓	✓
720×480i@60	✓	✓
720×480p@60	✓	✓
720×576i@50	✓	✓
720×576p@50	✓	✓
800×600p@56/60/72/75/85	✓	✓
848×480p@60	✓	✓
1024×768p@60/70/75/85	✓	✓
1152×864p@75	✓	✓
1280×720p@50/60	✓	✓
1280×768p@60/75/85	✓	✓
1280×800p@60/75/85	✓	✓
1280×960p@60/85	✓	✓
1280×1024p@60/75/85	✓	✓
1360×768p@60	✓	✓
1366×768p@60	✓	✓
1400×1050p@60	✓	✓
1440×900p@60/75	✓	✓
1600×900p@60RB	✓	✓
1600×1200p@60	✓	✓
1680×1050p@60	✓	✓
1920×1080i@50/60	✓	✓
1920×1080p@24/25/30	✓	✓

Supported Resolutions (Hz)	Input	Output
	HDMI	HDBaseT
1920×1080p@50/60	✓	✓
1920×1200p@60RB	✓	✓
2560×1440p@60RB	×	×
2560×1600p@60RB	×	×
2048×1080p@24/25/30	✓	✓
2048×1080p@50/60	✓	✓
3840×2160p@24/25/30	✓	✓
3840×2160p@50/60 (4:2:0)	✓	✓
3840×2160p@24, HDR10	✓	AVLC
3840×2160p@50/60 (4:2:0), HDR10	✓	AVLC
3840×2160p@50/60	✓	AVLC
4096×2160p@24/25/30	✓	✓
4096×2160p@50/60 (4:2:0)	✓	✓
4096×2160p@24, HDR10	×	×
4096×2160p@50/60 (4:2:0), HDR10	×	×
4096×2160p@50/60	×	×

8.3 Audio Specifications

8.3.1 Digital Audio

HDMI Input/Output	
LPCM	
Max Channels	8 Channels
Sampling Rate (kHz)	32, 44.1, 48, 88.2, 96, 176.4, 192
Bitstream	
Supported Formats	Standard & High-Definition

8.3.2 Analogue Audio

Analogue Output	
Max Audio Level	2Vrms
THD+N	< -80dB@0dBFS 1kHz (A-wt)
SNR	> 100dB@0dBFS
Frequency Response	< ±0.5dB@20Hz~20kHz
Crosstalk	< -90dB@10kHz
Impedance	470Ω
Type	Unbalanced

8.4 Cable Specifications

Cable Length	1080p		4K30	4K60
	8-bit	12-bit	(4:4:4) 8-bit	(4:4:4) 8-bit
High Speed HDMI Cable				
HDMI Input	15m	10m	5m	3m
Ethernet Cable				
Cat.5e/6	60m		35m	
Cat.6a/7	70m		40m	

Bandwidth Category Examples:

1080p (FHD Video)

- Up to 1080p@60Hz, 12-bit colour
- Data rates lower than 5.3Gbps or below 225MHz TMDS clock

4K30 (UHD Video)

- 4K@24/25/30Hz & 4K@50/60Hz (4:2:0), 8-bit colour
- 4K@50/60Hz (4:4:4, 8-bit) with AVLC active
- Data rates higher than 5.3Gbps or above 225MHz TMDS clock but below 10.2Gbps

4K60 (UHD+ Video)

- 4K@50/60Hz (4:4:4, 8-bit), AVLC required over HDBaseT
- 4K@50/60Hz (4:2:0, 10-bit HDR), AVLC required over HDBaseT
- Data rates higher than 10.2Gbps

8.5 HDBaseT Features

HDBaseT Feature Set	Transmitter
Video & Audio Extension	Supported
LAN Extension	Unsupported
Send power to Receiver	Supported (PoH)
Accept power from Receiver	Unsupported
IR Extension	Supported
RS-232 Extension	Unsupported
USB 2.0 Extension	Unsupported

9. ACRONYMS

ACRONYM	COMPLETE TERM
ASCII	American Standard Code for Information Interchange
AVLC	Adaptive Visually Lossless Compression
Cat.5e	Enhanced Category 5 cable
Cat.6	Category 6 cable
Cat.6a	Augmented Category 6 cable
Cat.7	Category 7 cable
CLI	Command-Line Interface
DAC	Digital-to-Analogue Converter
DHCP	Dynamic Host Configuration Protocol
DVI	Digital Visual Interface
EDID	Extended Display Identification Data
GUI	Graphical User Interface
HD	High-Definition
HDBT	HDBaseT
HDCP	High-bandwidth Digital Content Protection
HDMI	High-Definition Multimedia Interface
HDR	High Dynamic Range
HDTV	High-Definition Television
IP	Internet Protocol
IR	Infrared
LAN	Local Area Network
LED	Light-Emitting Diode
LPCM	Linear Pulse-Code Modulation
MAC	Media Access Control
OLED	Organic Light-Emitting Diode

ACRONYM	COMPLETE TERM
OSD	On-Screen Display
PD	Powered Device
PoH	Power over HDBaseT
PSE	Power Sourcing Equipment
SNR	Signal-to-Noise Ratio
TCP	Transmission Control Protocol
THD+N	Total Harmonic Distortion plus Noise
UHD	Ultra-High-Definition (10.2Gbps)
UHD+	Ultra-High-Definition Plus (18Gbps)
UHDTV	Ultra-High-Definition Television
USB	Universal Serial Bus
WUXGA (RB)	Widescreen Ultra Extended Graphics Array (Reduced Blanking)



CYP (UK) Ltd., Unit 7, Shepperton Business Park, Govett Avenue, Shepperton,
Middlesex, TW17 8BA

Tel: +44 (0) 20 3137 9180 | Fax: +44 (0) 20 3137 6279

Email: sales@cypeurope.com

www.cypeurope.com

v1.01