

# USER MANUAL



## Avonic 4K60 PTZ Camera 30x Zoom CM93-IP

# DISCLAIMER, CONTACT, IP RATING, AND MARKING

## Disclaimer

All text, graphics, photographs, trademarks, logos, artwork and computer code (collectively, "Content"), including but not limited to the design, structure, selection, coordination, expression, "look and feel" and arrangement of such Content, contained in this Manual is owned, controlled or licensed by or to Avonic, and is protected by trade dress, copyright, patent and trademark laws, and various other intellectual property rights and unfair competition laws.

Except as expressly provided in these Terms of Use, no Content of this Manual may be copied, reproduced, republished, uploaded, posted, publicly displayed, encoded, translated, transmitted or distributed in any way (including "mirroring") to any other computer, server, Web site or other medium for publication or distribution or for any commercial enterprise, without the prior written consent of Avonic.

## Copyright © 2023 AVONIC All Rights Reserved.

The information contained in this Manual is subject to change without notice.

## Contact Info

For any questions or suggestions, contact your reseller or local distributor of Avonic.

Visit the Avonic website [www.avonic.com](http://www.avonic.com) to find your local Avonic distributor or to download the most recent version of the documentation.

## Join Avonic on Social Media



[www.Facebook.com/avonicPTZ](http://www.Facebook.com/avonicPTZ)



[www.instagram.com/avonicPTZ](http://www.instagram.com/avonicPTZ)



[www.Linkedin.com/company/avonic](http://www.Linkedin.com/company/avonic)



[www.youtube.com/channels/avonic](http://www.youtube.com/channels/avonic)



[www.twitter.com/avonic](http://www.twitter.com/avonic)

## IP Rating

The IP Rating (ingress protection) for this Product is IP30. This means that the Product has an intrusion protection against solid objects over 2.5mm, e.g. tools & wires and has no moisture protection.

## Product and package marking

The Product has EU and US markings. The labels are placed at the bottom of the Product and on the packaging. See the respective figures below:

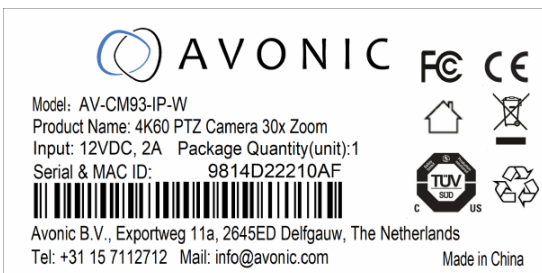

Figure 1: Marking (Product)

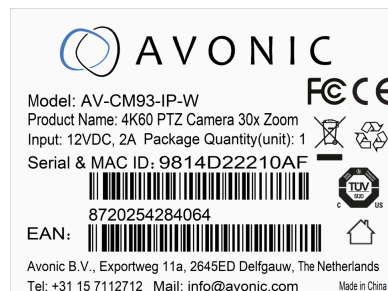

Figure 2: Marking (Packaging)

# IMPORTANT INFORMATION

## Liability

Avonic will NOT be held responsible for any damage or injury caused by unqualified persons carrying out these tasks, or by not following the instructions in this Manual.

## Intended Use and Non-Intended Use

### Installation



The following applies to the **installation** of the camera:

- The installation activities in this Manual should ONLY be executed by experienced technicians.
- The installation activities should NOT be executed by minors, mentally disabled persons or other persons not qualified to perform these tasks.





### Operation





The following applies to the **operation** of the camera:





- The operational activities described in this Manual should ONLY be executed by people with enough technical knowledge to perform the activities in a safe manner.
- This Product is specifically developed for video conferencing / streaming via internet by companies, institutes and universities. It is NOT meant for private use in the residential area.
- This Product should ONLY be used indoors.
- This Product is NOT a medical device and should NOT be used as a substitute for professional medical judgment. It is NOT designed or intended for use in the diagnosis of disease or other conditions, or in the cure, mitigation, treatment, or prevention of any condition or disease. Please consult your healthcare provider prior to making any decisions related to your health.

### Important Precautions

	This Product is NOT intended for use where failure of the device could lead to death, personal injury, or severe environmental damage.
	Be sure that you have COMPLETELY READ and UNDERSTOOD ALL information in this Manual before unpacking, installing and using this Product. Keep the Manual in a safe place for future reference or download it from <a href="http://www.avonic.com">www.avonic.com</a> .
	Failure to follow the SAFETY NOTES as described in this chapter could result in fire, electric shock, injury, or damage to this Product or other property.
	Power this Product ONLY with the included cable and power adapter. Other adapters may not meet applicable safety standards, and could pose a risk of death or injury when connected.

## Symbols Used in This Manual

Symbol	Meaning	Description
	Danger	Not following the instructions associated with this symbol may lead to personal injury and / or serious damage to the Product.
	Electrical Shock	Not following the instructions associated with this symbol may lead to life-threatening situations and / or serious damage to the Product.

Symbol	Meaning	Description
	Listed	Not following this information or instructions may lead to injury and/or damage to the product. Read the instructions in the user manual first before you use the product!
	Important	The information associated with this symbol requires special attention.
	Information	The information associated with symbol refers to a general remark or a reference to other documentation.
	Instruction	This symbol refers to one or more user instructions that must be followed as is documented in the user manual.
	Recycling	Specific parts of the Product can be re-used.

## Acronyms

The following acronyms are used in this Manual:

<b>AAE</b>	Aperture Auto Exposure
<b>AWB</b>	Auto White Balance
<b>BLC</b>	Back Light Compensation
<b>CMOS</b>	Complementary Metal Oxide Semiconductor
<b>DRC</b>	Dynamic Range Compression
<b>EV</b>	Exposure Value
<b>HD</b>	High Definition
<b>HDMI</b>	High-Definition Multimedia Interface
<b>IP</b>	Internet Protocol
<b>MJPEG</b>	Motion-JPEG
<b>NR</b>	Noise Reduction
<b>OSD</b>	On-Screen Display
<b>PoE</b>	Power over Ethernet
<b>PTZ</b>	Pan / Tilt / Zoom
<b>RTMP</b>	Real-Time Messaging Protocol
<b>RTSP</b>	Real-Time Streaming Protocol
<b>SAE</b>	Shutter Auto Exposure
<b>SDI</b>	Serial Digital Interface
<b>SKU</b>	Stock Keeping Unit
<b>SNR</b>	Signal to Noise Ratio
<b>SRT</b>	Secure Reliable Transport
<b>TCP</b>	Transmission Control Protocol
<b>UDP</b>	User Datagram Protocol

# Contents

DISCLAIMER, CONTACT, IP RATING, AND MARKING.....	ii
IMPORTANT INFORMATION.....	iii
Liability.....	iii
Intended Use and Non-Intended Use.....	iii
Installation.....	iii
Operation.....	iii
Important Precautions.....	iii
Symbols Used in This Manual.....	iii
Acronyms.....	iv
INTRODUCTION.....	8
Purpose of This Manual.....	8
Target Audience.....	8
Document Structure.....	8
SAFETY INSTRUCTIONS.....	9
Intended Use.....	9
Important Precautions.....	9
Handling.....	9
Mounting.....	9
Ventilation.....	10
Repair.....	10
Power and Adapter.....	10
Atmospheric Conditions.....	10
PRODUCT OVERVIEW.....	11
UNPACKING.....	12
Package Contents.....	12
Handling Precautions.....	13
Unpacking the Camera.....	13
Return Procedure.....	13
MOUNTING AND INSTALLATION.....	14
Mounting on Wall or Ceiling.....	14
Connecting the Components to the Camera.....	15
Balanced Audio Connection.....	15
Connecting a Controller to a Camera.....	16
Connecting the camera to a local network.....	16
Connecting via USB, HDMI or SDI.....	16
Serial Connecting via RS-232 or RS-485.....	17
Connecting via LAN.....	18
OPERATION.....	19
WebGUI.....	19
Login.....	19
Preview (LOCAL).....	20
First time usage.....	21
AUDIO.....	24
VIDEO.....	25
Using the Remote Control.....	42
a. Power.....	42
b. Set.....	42
c. Camera Select.....	43
d. Number Keys.....	43
e. Focus + -.....	43
f. Auto/Manual Focus.....	43

g. Zoom + -.....	43
h. Set & Clear Preset.....	44
i. PTZ Keys (up/down/left/right).....	44
j. Home.....	44
k. BLC ON/OFF.....	44
l. Menu.....	44
m. Function Keys (F1/F2/F3/F4).....	44
n. Blank Buttons.....	44
Other Key Combinations.....	45
Tally Light Functionality.....	45
OSD Menu.....	46
1. MENU.....	47
2. SETUP.....	47
3. CAMERA.....	47
3.1 EXPOSURE.....	48
3.2 COLOR.....	48
3.3 IMAGE.....	48
3.4 FOCUS.....	49
3.5 NOISE REDUCTION.....	49
3.6 STYLE.....	49
4. PTZ.....	49
5. VIDEO FORMAT.....	50
6. NETWORK SETTINGS.....	50
7. VERSION.....	50
8. RESTORE DEFAULT.....	50
Using the System Select.....	51
MAINTENANCE.....	52
Camera Maintenance.....	52
Usage Precautions.....	52
TRANSPORT AND STORAGE.....	53
DISPOSAL AND RECYCLING.....	54
TROUBLESHOOTING.....	55
General.....	55
Power Issues.....	55
Image.....	55
No image.....	55
Abnormal image.....	55
Dithering or flickering image.....	55
Color issues.....	55
Autofocus Issues.....	56
Control.....	56
No self-test (PTZ cameras only) and no power LED.....	56
Remote Controller does not work.....	56
Camera does not respond to commands send over IP.....	56
WebGUI.....	56
Cannot enter WebGUI.....	56
Firmware update failed.....	56
APPENDIX A - VISCA SETTINGS AND COMMAND LIST.....	57
VISCA over Serial Connection.....	57
VISCA over IP.....	57
VISCA over IP using the full Sony VISCA protocol.....	59
Camera Return Commands.....	60
Camera Control Commands.....	61
Inquiry Commands.....	67
APPENDIX B - DIMENSIONS.....	71

APPENDIX C - HTTP API.....	72
How to use HTTP API.....	72
Curl.....	73
{"GetEnv"}.....	74
HTTP API code list.....	75
IR Remote Control.....	75
PTZ.....	75
Audio.....	77
Video.....	78
Network.....	87
System.....	88
APPENDIX D - CMOS SENSOR CHARACTERISTICS.....	91
APPENDIX E - DATASHEET (SPECIFICATIONS).....	92
SPECIFICATIONS.....	92
Index.....	93

# INTRODUCTION

## Purpose of This Manual

This Manual describes the safety precautions and the instructions for safe unpackaging, installation, operation, maintenance and disposal of the Avonic CM93-IP cameras.



In this Manual, the Avonic CM93-IP camera is referred to as the 'Product'.

## Target Audience

This Manual is developed for installation technicians who install the Product at client sites, and for IT professionals who are responsible for operating the Product.

## Document Structure

The Manual is subdivided into the following **Chapters**:

1. Introduction
2. Safety
3. Product Overview
4. Unpacking
5. Mounting and Installation
6. Operation
7. Maintenance
8. Transport and Storage
9. Disposal and Recycling
10. Troubleshooting

Additionally, it contains the following

- Appendix A - VISCA Settings and Command List
- Appendix B - Dimensions
- Appendix C - HTTP API
- Appendix D - CMOS Image Sensor Characteristics
- Appendix E - Datasheet (Specifications)



# SAFETY INSTRUCTIONS





This chapter contains important safety information regarding the unpacking, installation and use of the camera.

## Intended Use



See section [Intended Use and Non-Intended Use](#) on page iii for details.

## Important Precautions

	This Product is NOT intended for use where failure of the device could lead to death, personal injury, or severe environmental damage.
	Be sure that you have COMPLETELY READ and UNDERSTOOD ALL information in this Manual before unpacking, installing and using this Product. Keep the Manual in a safe place for future reference or download it from <a href="http://www.avonic.com">www.avonic.com</a> .
	Failure to follow the SAFETY NOTES as described in this chapter could result in fire, electric shock, injury, or damage to this Product or other property.
	Power this Product ONLY with the included cable and power adapter. Other adapters may not meet applicable safety standards, and could pose a risk of death or injury when connected.

## Handling



To prevent the risk of injury, take the following precautions when handling this Product:

- Handle the Product with care. It is made of metal, glass, and plastic and has sensitive electronic components inside.
- The Product can be damaged if dropped, burned, punctured or crushed, or if it comes into contact with liquid.
- Do not pick up and move the Product unit while a tripod is attached. The fitting may break under the weight of the tripod, which may result in injury.
- If you suspect any damage to the Product, discontinue its use, as it may cause overheating or injury.

## Mounting



To prevent the Product from falling down which may cause injuries:

- Set up this Product on a hard, stable surface or mount it to a wall or ceiling.
- ONLY use an Avonic mount for mounting to a wall or ceiling.
- Ensure the mounting construction is capable of supporting four times the weight of the Product. (See 'General Specifications > Weight product' in the Product Datasheet for the exact weight.)
- Use a safety loop or drop protection that prevents the Product from falling if the mounting construction fails.
- During installation, NEVER install a Product above a person.
- Check the installation at least once a year. An improper mounting could cause the unit to fall off, resulting in personal injury.

## Ventilation



To prevent the risk of life-threatening injury or damage to the Product or other property, caused by electric shock or fire hazard due to overheating:

- Maintain adequate ventilation by NOT installing or placing the Product unit in a bookcase, built-in cabinet or any other confined space.
- Ensure that curtains or any other material does NOT obstruct the ventilation.

## Repair



Take the following precautions if the Product should be repaired:

- Don't open this Product and don't attempt to repair it yourself. Disassembling the Product may damage it or may cause injury to you.
- If this Product is damaged, malfunctioning, or if it comes into contact with liquid, contact Avonic or an Avonic Authorized Service Provider.
- Repairs by service providers other than Avonic or an Avonic Authorized Service Provider may not involve the use of Avonic genuine parts and may affect the safety and functionality of the device. You can find more information about repairs and service at [www.avonic.com](http://www.avonic.com).

## Power and Adapter



To prevent the risk of life-threatening injury or damage to the Product or other property, caused by electric shock or fire hazard:

- Power this Product ONLY with the included cable and power adapter. Other adapters may not meet the applicable safety standards. They could pose a risk of death or injury when connected.
- Do NOT use damaged cables.
- Do NOT power the Product in a moist / wet environment.
- Before you power the Product, ensure the cable is fully inserted into the power adapter.
- Plug the power adapter directly into a power outlet.
- Do NOT use the power adapter at a moist / wet location.
- Do NOT connector disconnect the power adapter with wet hands.
- Keep the Product, cable, and power adapter in a dry and well-ventilated area when in use.
- Stop using the power adapter and any cables if any of the following conditions exist:
  - The power adapter plug or prongs are damaged.
  - The cable becomes frayed or otherwise damaged.
  - The power adapter is exposed to excessive moisture, or liquid is spilled into it.
  - The power adapter has been dropped, and its enclosure is damaged.

## Atmospheric Conditions



To prevent the risk of injury or damage to the Product or other property caused by a potentially explosive atmosphere:

- Do NOT use this Product in an area with a potentially explosive atmosphere, such as areas where the air contains high levels of flammable chemicals, vapors, or particles (such as grain, dust, or metal powders), may be hazardous.
- Exposing this Product to environments having high concentrations of industrial chemicals, including near evaporating liquified gasses such as helium, may damage or impair this Product functionality.
- Obey all signs and instructions.

# PRODUCT OVERVIEW

## Description

The CM93 is the most versatile PTZ camera from Avonic that delivers 4K Ultra HD output at 60fps. Designed for fixed installations, the CM93 comes with 50x zoom in Full HD and 30x zoom in 4K. Available as IP or NDI® | HX, setting the new standard in ultra-low latency.

The new standard in 4K PTZ cameras has a 59.2°-degree wide-angle lens and simultaneous HDMI 2.0, 3G-SDI, USB 2.0, and IP stream outputs. The high-quality Sony CMOS sensor with HDR support has the ability to deliver pristine image quality, even under low light conditions.

Pan, Tilt, and Zoom your way into outstanding high-quality 4K video content with Avonic's CM93-IP or CM93-NDI PTZ Camera.



## Features

The CM93-IP and NDI camera has the following features:

### Fast over IP

Distribute high-quality video over IP, fast and reliable with close to zero latency. This new standard in ultra-low latency encoding, using open standards like H.264 and HVEC, is the closest thing to real-time available on the market today. Less delay means a better experience for everyone watching. From streaming and recording lectures and large conferences to healthcare applications.

### Fluent 4K60 video

With 60 frames per second, the Avonic CM93 delivers high-quality 4K Ultra HD output. A big difference with the standard 4K 30fps PTZ cameras being used in fixed installations. Processing image with 60 frames per second, provides a pristine image quality via simultaneous video outputs.

### Every environment

Most cameras have a hard time coping with changing lighting conditions during the day affecting the video output. The high-quality glass lens with 30x Zoom, captures images with superb sensitivity and natural color rendering, achieving pristine image quality even under the most challenging light conditions.

### Tested and validated

Avonic cameras are tested and validated with many leading brands in the Pro-AV industry like Bosch, MVI, Televec, Skaarhoj, Roland Professional AV, and more. Our interoperability and easy installation, give integrators peace of mind during installation.

# UNPACKING

This describes the contents of a complete Product package, and instructions for safe unpacking and (if necessary) Product return.

## Package Contents

The following tables contains an overview of the package contents of the Product.

No.	Quantity	Description	Avonic SKU
1	1 pc	PTZ Camera	AV-CM93-IP-B/W
2	1 pc	Remote Control	AV-CM40-RC
3	1 pc	USB cable type A to type B	AV-USB20-AB
4	1 pc	* Power Adapter 12V/A (GME Technology (Shenzhen) Co., Ltd , model number: GME24A - 120200FDS2)	AV-CM40-PSU
5	1 pc	RS-232 9-pin D-Sub female to DIN -8 male	AV-CM-RS-232
6	1 pc	5-way Phoenix Balanced audio con. (CTBP92HE/5)	AV-PHNX-5
7	1 pc	2-way Phoenix RS-485 connector	AV-PHNX-2

Each item is visualized below and referenced by the associated number in the table above:



Figure 3: Package Contents

## Power Adapter Usage

\* Use only the Power Adapter of GME Technology (Shenzhen) Co., Ltd with model number: GME24A - 120200FDS2 in combination with the CM93 camera. Using another Power Adapter may lead to injury and/or damage to the product. See the picture of the Power Adapter label at the left:



Figure 4: Power Adapter label



Figure 5: Power plugs

\* Note also that the plug of the power plug cable related to the power adapter can be different according to the above mentioned picture of the package contents. This depends on the electrical system that is used in the country you live in. This is the case for UK an Australian customers for example. See the picture above at the right.

## Handling Precautions



Always take the camera by its base and do **not** move the position of the lens manually. See below.

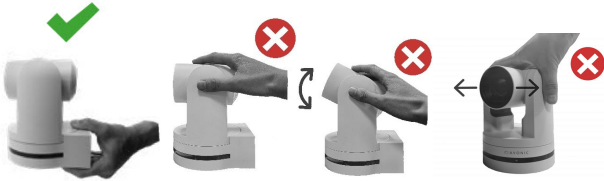

Figure 6: Handling Precautions

## Unpacking the Camera



Execute the following steps to unpack the camera and associated components:

1. Open the box.
2. Verify that the contents of the box exactly matches the items as described in [Package Contents](#) on page 12. If this is NOT the case, contact Avonic and stop here.

The camera should be in its protective foam as follows:



Figure 7: Camera in Foam

3. Verify that the plastic camera bag is sealed. If this is NOT the case, contact Avonic and stop here.
4. Break the seal of the sealed camera bag.
5. Take the camera out of the bag. Be sure to follow the [Handling Precautions](#) on page 13 while doing so.
6. Install the camera following the steps as described in the chapter [MOUNTING AND INSTALLATION](#) on page 14

## Return Procedure



If, for any reason, you have to return the camera to Avonic, Execute the following steps:

1. Place the camera back in its protective foam. Verify that the lens is in HORIZONTAL position!
2. Place the camera with **all** of its components in the box.
3. Verify that the contents of the box **exactly** matches the items as described in [Package Contents](#).
4. Contact [Avonic](#) for the Return Procedure.

# MOUNTING AND INSTALLATION

This chapter describes the steps you have to perform to mount and install the Product in a correct and safe manner.

These steps are subdivided into the following groups, each of which is described in a separate section:

1. Mounting on Wall or Ceiling
2. Connecting the Components to the Camera
3. Connecting a Controller to a Camera
4. Connecting the camera to a local network



Take the following precautions to prevent the Product from falling down which may cause injuries:

- Set up this Product on a hard, stable surface, or mount it to a wall or ceiling.
- ONLY use an Avonic mount for mounting to a wall or ceiling.
- Ensure the mounting construction is capable of supporting four times the weight of the Product. (See 'General Specifications > Weight product' in the Product Datasheet for the exact weight.)
- Use a safety loop or drop protection that prevents the Product from falling if the mounting construction fails.
- During mounting and installation, NEVER install a Product above a person.
- Check the installation at least once a year. An improper mounting could cause the unit to fall off, resulting in personal injury.

## Mounting on Wall or Ceiling

The following accessories (AV-MT300) are separately available if the client wants to mount the camera to the wall or ceiling. Contact your Avonic reseller or local distributor for purchasing details.



### Wall and Ceiling mount (AV-MT300)

SKU white: AV-MT300-W

SKU black: AV-MT300-B



Visit [www.avonic.com](http://www.avonic.com) to download instructions for mounting the camera to the wall or ceiling using the accessory AV-MT300.

## Connecting the Components to the Camera



Execute the following steps to connect the components to the camera:

1. Connect all provided components (see [Package Contents](#)) to the ports at the rear of the camera. The figure below shows the applicable ports.

	<ol style="list-style-type: none"> <li>1. Balanced Audio Line in 5-pin Phoenix connector</li> <li>2. RS-232 mini-DIN-8 IN (connect the supplied RS-232 cable)</li> <li>3. RS-232 mini-DIN-8 OUT for daisy chaining RS-232 connection</li> <li>4. RS-485 two-wire serial communication with 2-pin Phoenix connector</li> <li>5. Kensington Lock</li> <li>6. System Select (see <a href="#">Using the System Select</a>)</li> <li>7. HDMI Type A</li> <li>8. USB2.0 Type B, UVC video output and control</li> <li>9. BNC 3G-SDI output, SMPTE 425M level A.</li> <li>10. RJ45 Ethernet, with PoE (48Vdc, 0.25A, comply with LPS/PS2 circuits)</li> <li>11. DC12V power with locking screw (connect the supplied DC PSU)</li> <li>12. Power ON/OFF</li> <li>13. Fall protection eye</li> </ol>
--	---

Figure 8: Camera Ports

2. If you have connected the power cable to the camera, set the power switch at the back of the camera to the 'ON' position. If you use a PoE Ethernet connection, ensure that the Power switch is always 'ON'.

After empowering the camera, it starts initializing by first rotating the Pan-Tilt to the maximum top right position and then to the center.



If position preset '0' has been stored, this is the position that will be called after initialization.

The current IR-channel setting and IP Address of the camera are displayed on the [OSD Menu](#).

From this point onwards, the user can start controlling the camera.

### Balanced Audio Connection

To connect balanced audio to the camera, you need the following:

- Double Male XLR cable with the possibility to connect it to a 5 pins phoenix connector (CTBP92HE/5: see [package contents](#)).
- Audio input device with multiple XLR input/ outputs, such as a mixer. (It is also possible to use audio over HDMI) on the website and scroll down.)
- PoE (CAT) cable for streaming. See below:

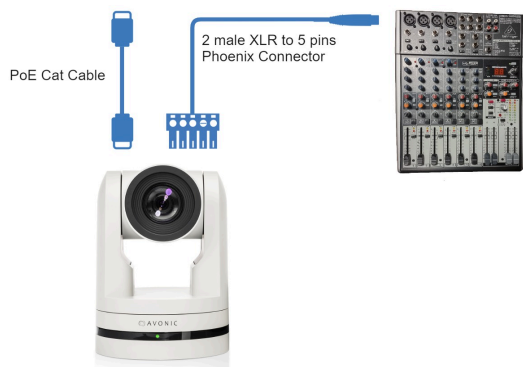



Follow the instructions below to connect the audio cable to the phoenix and the XLR connectors.

1. Connect the wires of the audio cable as is shown in picture 1 to both XLR connectors. Note that the pictures of the connector's back are **mirrored!**
2. Connect the wires of the other side of the audio cable as is shown in picture 2.



Take note that the colors of the wires could be different in your audio cable according to the pictures (XLR and Phoenix connector) below. You need to know which one are the right and left channels and which one is the GND (ground).

**Picture 1: XLR connector**

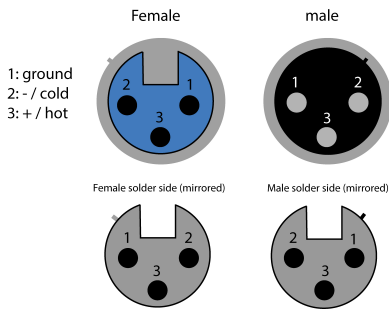

**Picture 2: Phoenix connector**

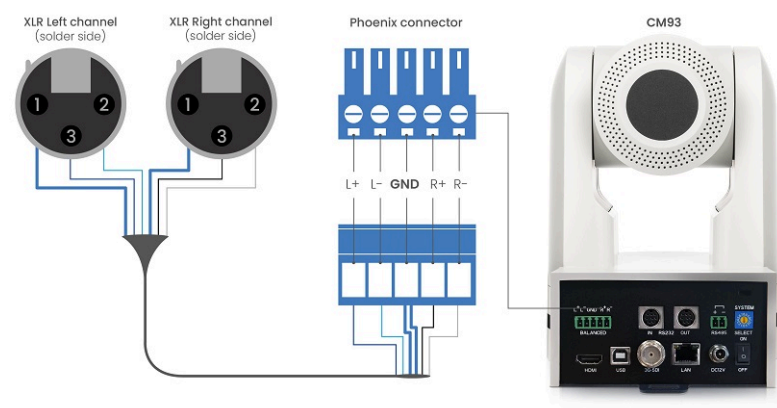

## Connecting a Controller to a Camera

You can connect one or more cameras to a VISCA (serial) controller.



See <https://avonic.com/en/product-categorie/controllers/> for an overview of the available controllers.

A controller gives you direct control over the most important camera settings (e.g., Pan, Tilt, Zoom, Focus, White Balance). You can access all other settings through the [OSD Menu](#) of the camera using the controller.

## Connecting the camera to a local network

The camera can be connected via a serial connection to USB, HDMI, SDI, RS-232, RS-485, or via a LAN Ethernet connection. Each of these options is described below.

### Connecting via USB, HDMI or SDI



Execute the following steps to connect the camera to a desktop or a (computer) monitor via USB, HDMI or SDI:

1. Connect the camera to the desktop or monitor via the USB, HDMI or SDI port (see figure above).
2. Open the Windows Camera app or a third-party camera app.
3. Open the Settings.
4. Select the camera you just connected, or click on the option / icon to change the camera to the camera you just connected.
5. Press the [MENU](#) button on the provided IR Remote Control to open the [OSD Menu](#).



See [Using the Remote Control](#) for more information on how to use the Remote Control.



## Serial Connecting via RS-232 or RS-485

### COM Port Settings

In default working mode, the camera can connect to a VISCA controller via an RS-232 or RS-485 serial interface. The applicable COM port settings are (where '\*' stands for 'Default value'):

#### RS-232

- Baudrate: 2400/4800/9600\*/115200
- Start bit: 1 bit
- Data bit: 8 bits
- Stop bit: 1 bit

#### RS-485 (half-duplex mode)

- Baudrate: 2400/4800/9600\*
- Start bit: 1 bit
- Data bit: 8 bits
- Stop bit: 1 bit

### RS-232 Interface



Connect the controller to the back of the camera via the RS-232 cables as shown below:

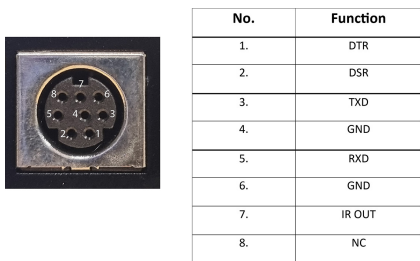

Figure 9: RS-232 Interface (Mini DIN-8)

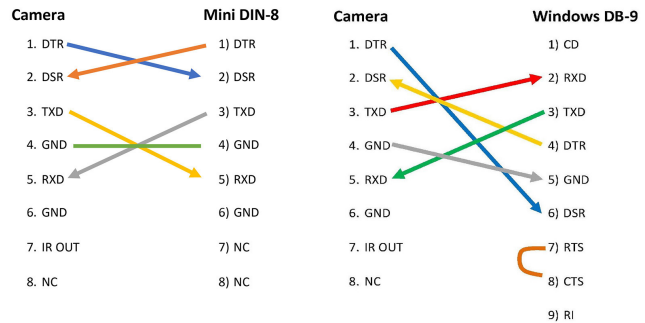

Figure 10: RS-232 Cable and Interface Connection (Mini DIN-8 and Windows DB-9)

### RS-232 Network Connection



Execute the following step to connect the controller to the back of the camera(s) via RS-232:

1. Make the connection using **daisy chaining** network architecture. Keep in mind that the maximum cable length for RS-232 is 10-15m.

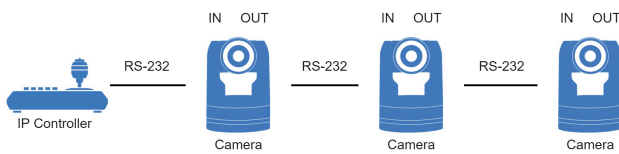

Figure 11: RS-232 Network Connection Diagram

### RS-485 Interface



Connect the controller to the + and - at the back of the camera via the RS-485 cables, as shown below. Note that the color of the connecting cables (orange and blue in the figure) may vary.



Figure 12: RS-485 Interface

## RS-485 Network Connection



Execute the following steps to connect multiple cameras to RS-485:

1. Attach the cameras to a 2-wire twisted pair bus (maximum length 1200m) that is terminated at both ends with a 120Ω-impedance resistor.
2. Ensure that the maximum distance from the bus to the back of the camera or controller is 5m. If you use only ONE camera, the impedance resistor is not needed.

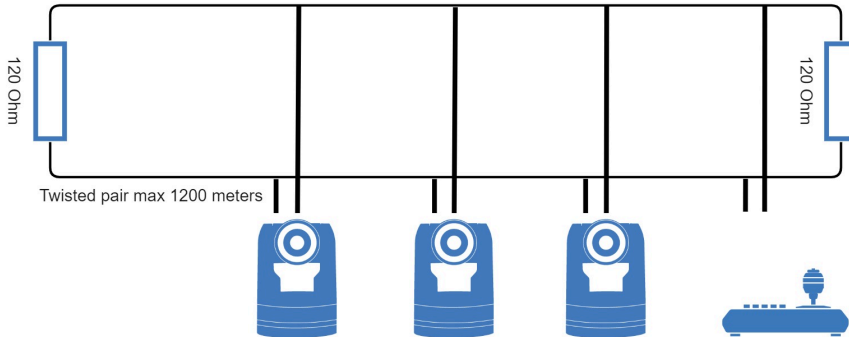

Figure 13: RS-485 Network Connection Diagram

## Connecting via LAN

Avonic IP cameras can be controlled by any device using the Visca over IP protocol (see the command list in [Appendix A - VISCA Settings and Command List](#)).

## Settings

By default, the IP address of the camera is "192.168.5.163" with "admin" for both the username and password.

The control parameters for the CM93 series cameras are as follows:

- IP Address: 192.168.5.163
- Username: admin
- Password: admin
- TCP or UDP port: 1259

## IP (Network) Connection



Execute the following steps an Avonic PoE camera to a LAN:

1. Use a standard (PoE) switch. If the unit is simultaneously connected to both PoE and its own power supply, the power supply will take priority. If the power supply is disconnected when PoE is present, the camera will remain operational without interruption.
2. Ensure that addressing is done via IP. When using VISCA over IP, the 'x' in all the '8x' addresses is always '1', where the Visca address in a Visca over IP environment is always 1. (See [Appendix A - VISCA Settings and Command List](#) for more information.)

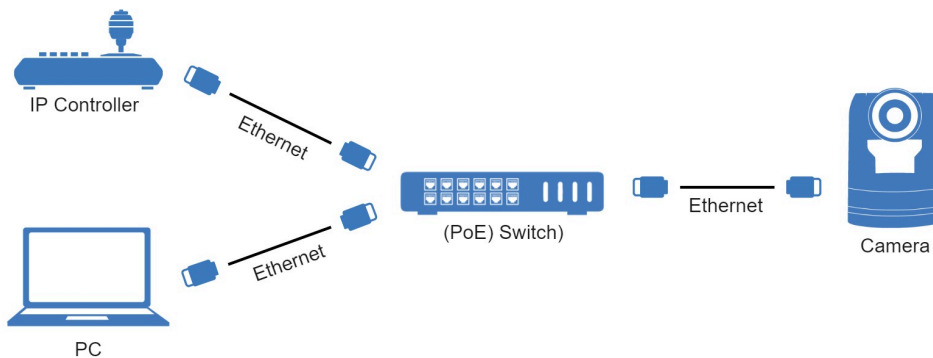

Figure 14: IP Network Connection Diagram

# OPERATION

This chapter describes all the camera features to help you to understand how the camera can be used. This is subdivided into the following sections:

1. [WebGUI](#)
2. [Using the Remote Control](#)
3. [Other Key Combinations](#)
4. [OSD Menu](#)
5. [Using the System Select](#)



If you want to read more about the functionality of the camera than is documented in this chapter, it is recommend to read the [support articles](#) from the list in appendix F.

## WebGUI

You can access change settings in the camera by using the WebGUI. The WebGUI can be accessed over IP using your local network.

### Login

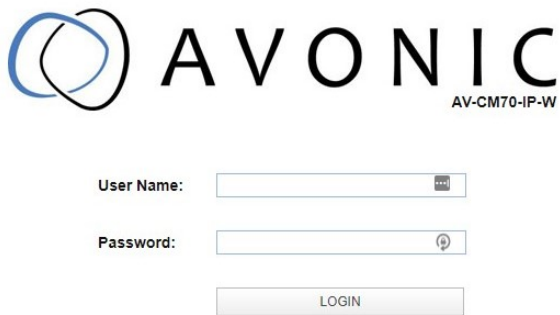

Figure 15: WebGUI > Login



Execute the following steps to log on to the WebGUI:

1. Open your web browser. Enter the default IP address "192.168.5.163". The "Login" screen appears.
2. Enter "admin" for both the Username and Password and Click **LOGIN** to continue. There is also a possibility to automatically fill in the Username and Password (see [User](#)).



- If **DHCP** is enabled and no **DHCP** server is available, the camera will automatically appoint an IPv4 link-local address between **169.254.0.0** and **169.254.255.255**. The IP address is shown on the screen at start-up
- If you don't know the cameras IP address read: [How do I know the IP address assigned to my camera?](#)

After a successful logon, the WebGUI is displayed. Here, you can select various tabs that are described below.

## Preview (LOCAL)

In this tab, you can see a preview of the camera IP video output.

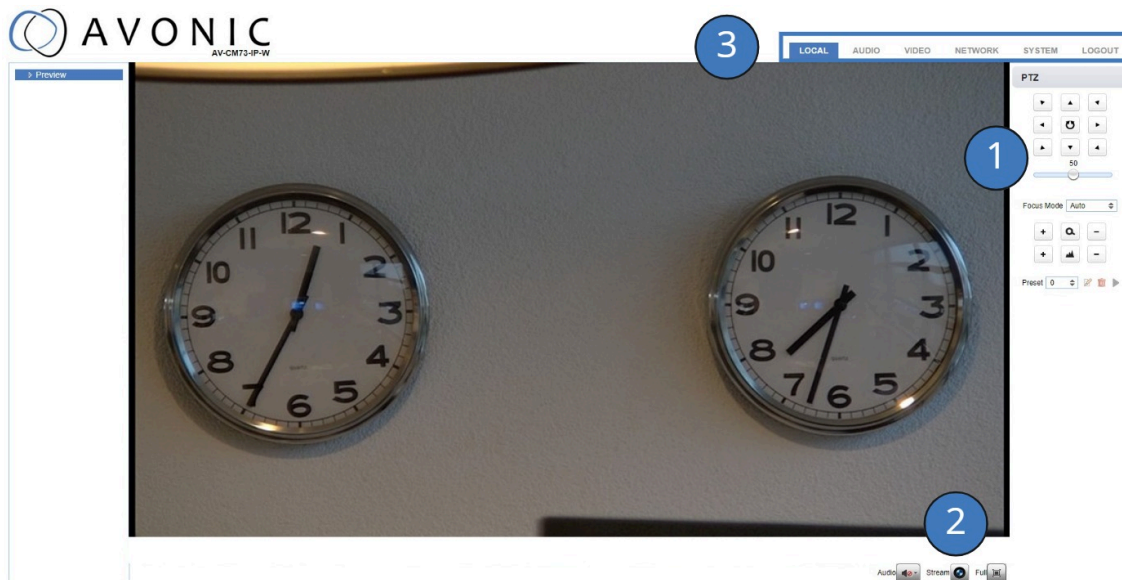

Figure 16: WebGUI > Preview

Next to the preview you see:

1. PTZ keys to move the lens of the camera and Focus keys (works only when the focus is set to manual). You can adjust the PTZ speed (the speed when the camera moves) by using the bar below the PTZ keys.
2. • Audio icon to set the audio to ON (Connect first an audio cable to the [balanced audio](#) input of the camera). Note that you first have enabled the [Audio Enable](#) at the Audio tab of the WebGUI.
  - Stream icon to switch the main and sub stream. Click the icon to switch to the sub stream and click again to turn back to the main stream.
  - Click the Full icon to switch to full screen. Press ESC to turn back to WebGUI Preview.
3. On top: The main tabs to enter different pages of the WebGUI.



The Preview feature works **ONLY** if the main or sub stream is set to 'H264' (see [VIDEO - Camera Settings](#)).

## Set, Call and delete presets



To set, call and delete presets do the following:

1. Set the camera in the desired position with the desired zoom and focus level.
2. Type the number of the preset under Preset and click on the **SET** icon.
3. To call a preset, select the number of that preset and click the **RUN** icon.
4. To delete a preset, select the preset number of that preset and click the **CLEAR** icon.

The presets stores the Pan, Tilt and position as well as zoom level (no exposure, or white balance settings). If manual focus is chosen, the focus position is also stored. If you use preset 0 to set a preset, note that when you start the camera again, the lens will automatically move to the camera position of preset 0 after the camera has started. Delete preset 0 to start the camera with the lens straight forward.

Next to the preset icons there is also a "Home" icon (at the center of the PTZ buttons). If you click on that icon, the camera will zoom out and moves to a position with the lens straight forward. The "Home" icon cannot be used as a (normal) preset and affects, like the presets, only the Pan, Tilt and Zoom position of the camera.

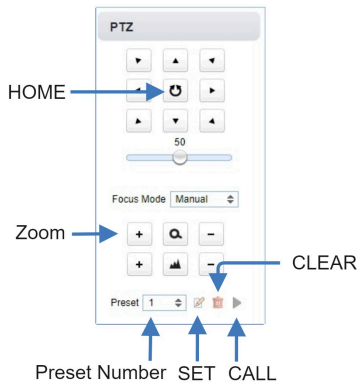

### First time usage

If you are using the camera for the first time, it is helpful for you first to setup the basic camera settings before explaining the functionalities of the camera in detail. According to the light conditions in your room or on stage, you can follow instructions at:

1. Basic Camera Setup
2. Basic Camera Setup using (semi)manual settings

### Basic Camera Setup

Do you have changing light conditions? Follow then the instructions below to set up the basic camera settings. After that you can read more about the functionality in this chapter.

#### 1. Connect cables

- Connect a CAT6a cable to the ethernet port of the camera and a (PoE) network switch. If you use a standard switch, connect also the power cable.
- Connect a HDMI or SDI cable to the camera and a monitor.
- Turn the ON/OFF button at the back of the camera to ON. When the camera starts, the lens will turn from back to forth and will finish with the lens straight forward. This will take a few seconds.

The image shows the back of the camera with various ports: a power jack, an Ethernet port, an HDMI port, and an SDI port. Blue arrows point to each of these ports. There is also a power button on the right side.

#### 2. Login and change output resolution

- Use the [standard IP address](#) and login to the WebGUI.
- Navigate to Output Format and change the video out format (over HDMI or SDI) when your monitor does not support the (standard) 4K video resolution. Change this to 1080p60 or lower. Click SAVE to save the new resolution format.
- You can also use the [System Select](#) at the back of the camera to change the video output format.

The screenshot shows the 'Output Format' settings in the WebGUI. It has two dropdown menus: 'Sdi Out Format' and 'Hdmi Out Format', both set to '1080P60'. A 'SAVE' button is at the bottom. Blue arrows point to the dropdown menus and the 'SAVE' button.

#### 3. Focus

- Navigate to Video > Camera Settings > Focus in the WebGUI.
- Choose Focus Mode > Auto
- At **AF-Mode** choose Moving Objects or Meeting. This depends on the person or object to be filmed:
  - **Moving Objects:** For a person or object that is moving a lot in any direction in the room or on stage.
  - **Meeting:** for general meeting purposes where the person or object in the room or on stage is not moving a lot.
- If you have chosen moving objects, set the **AF-Sensitivity** to high. You can leave it to low or middle when you have chosen Meeting at AF-Mode.

The screenshot shows the 'Focus' settings in the WebGUI. It has two sections. The top section shows 'Focus Mode' set to 'Auto', 'AF-Mode' set to 'Moving objects', and 'AF-Sensitivity' set to 'Front focus'. The bottom section shows 'Focus Mode' set to 'Auto', 'AF-Mode' set to 'Moving objects', and 'AF-Sensitivity' set to 'Low'. Blue arrows point to the 'AF-Mode' dropdown in both sections and the 'AF-Sensitivity' dropdown in the bottom section. Red text notes: '\*Click the "Refresh" Effective after change'.

#### 4. Exposure

Navigate to **Exposure** tab and set the **Gain Limit** (G.Limit). The higher the Gain Limit, the lighter will become the picture.

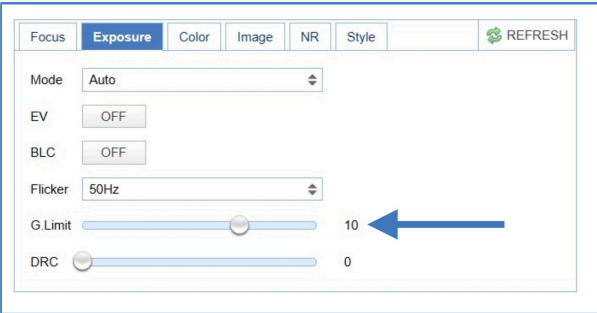

#### 5. Color

Navigate to the **Color** tab and set the **WB Mode** to Auto.

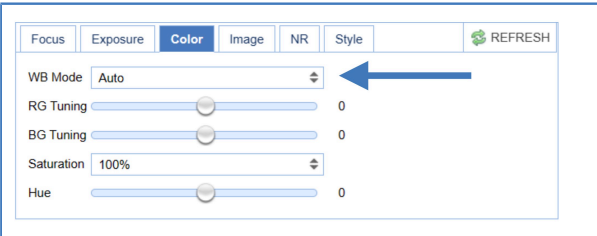

#### 6. Image

Navigate to **Image** tab and set the **sharpness**. The higher the number, the more sharp the picture will become.

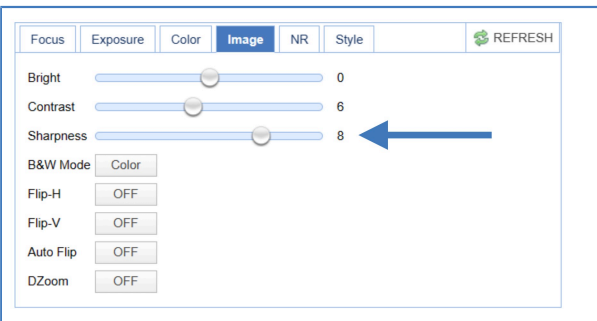

#### 7. Noise Reduction

Navigate to **Noise Reduction** tab and set the **NR** to OFF.



### Basic camera setup using (semi)manual settings

Do you have fixed light conditions? Or is the filmed person or object not clear towards the background and the autofocus has difficulties to find the correct focus? Then a (semi)manual setup is useful. Follow the instructions below:

#### 1. Connect cables

- Connect a CAT6a cable to the ethernet port of the camera and a (PoE) network switch. If you use a standard switch, connect also the power cable.
- Connect a HDMI or SDI cable to the camera and a monitor.
- Turn the ON/OFF button at the back of the camera to ON. When the camera starts, the lens will turn from back to forth and will finish with the lens straight forward. This will take a few seconds.



#### 2. Login and change output resolution

- Use the **standard IP address** and login to the WebGUI.
- Navigate to Output Format and change the video out format (over HDMI or SDI) when your monitor does not support the (standard) 4K video resolution. Change this to 1080p60 or lower. Click SAVE to save the new resolution format.
- You can also use the **System Select** at the back of the camera to change the video output format.

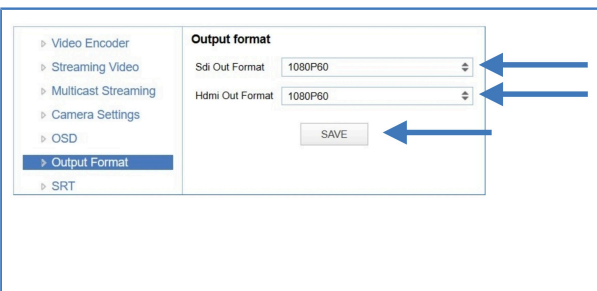

### 3. Focus

- Navigate to Video > Camera Settings > Focus
- If you have difficulties to focus, choose Focus Mode > Manual. Otherwise set the **Focus Mode** to Auto and choose at AF-Zone > Moving Objects if the filmed person or object is moving a lot, or Meeting for general meeting purposes.
- Set the **AF-Sensitivity** to high if you have chosen Moving Objects. Otherwise you can leave it to low.

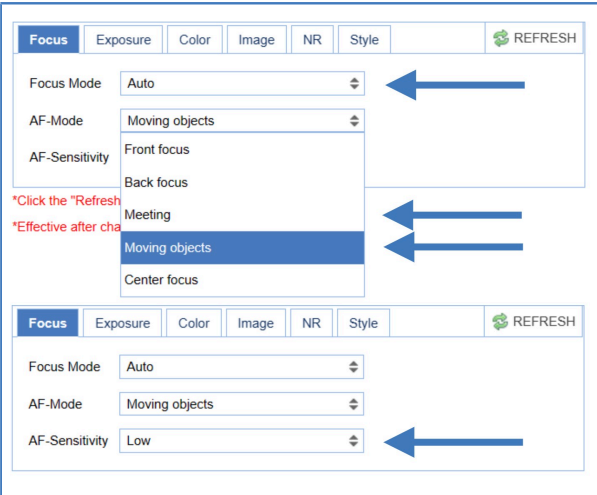

### 4. Exposure

- Navigate to the Exposure tab
- Choose one of the following at Mode:
  - **SAE**: Do you have fast moving persons or objects before the camera? Choose this mode to set the shutter speed.
  - **AAE**: Do you need more depth of field, because the distance between the camera and filmed object is large? Choose this mode to set the Iris (F-stop).
  - **Bright**: Do you have challenging light conditions? Choose this mode to set the artificial brightness.
  - **Manual**: Do you have fast moving person or object on large distance? Choose Manual to set the shutter speed and the Iris (F-stop).

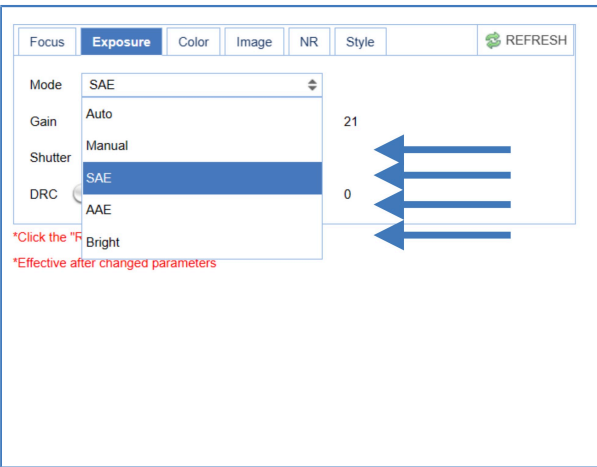

### 5. Color

- Navigate to the Color tab
- Choose at **WB Mode** one of the White Balance values (2400K ~ 7100K).
  - Do you have a lot of yellow light? Set the value of the WB Mode approximately between the 5000K and 7100K.
  - Do you have a lot of blue light? Set the value of the WB Mode approximately between the 2400K and 3300K.
- If needed change the **Hue** to compensate.

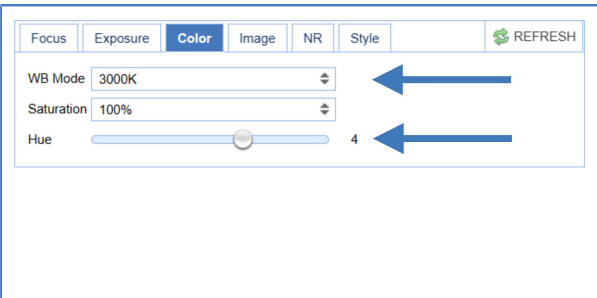

### 6. Image

- Navigate to the Image tab and set the **sharpness**.
- If needed change also the **bright** and **contrast** settings to add more brightness to the picture.

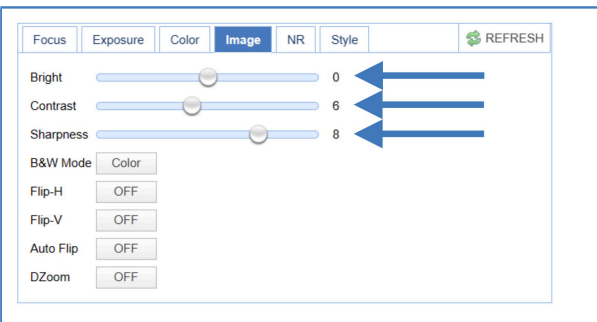

### 7. Noise Reduction

- Do you have a lot of noise in the picture? Navigate to the Noise Reduction tab and change the **NR** to smooth the picture over.



## AUDIO



Connect first an audio cable with XLR connectors to the 5 pins Phoenix connector and connect the cable to the camera. See [Balanced Audio Connection](#) on page 15

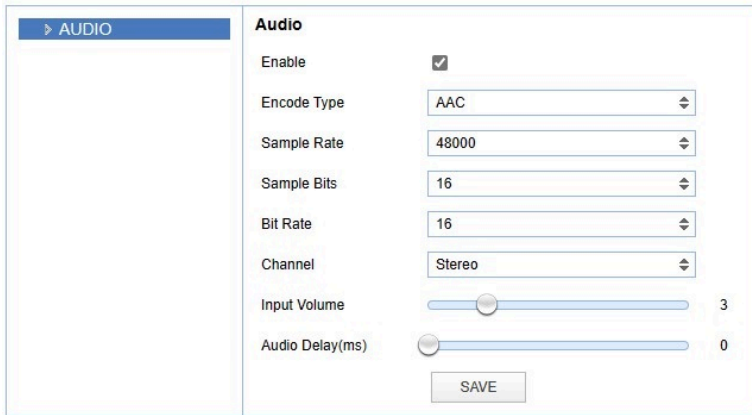

Figure 17: WebGUI > Audio



Make your settings as follows:

1. Enable (checked) or disable (blank) embedding of audio input (camera rear).
2. The encoding type: only AAC.
3. The sample rate: only 48000.
4. Set the sample bits always to 16.
5. Select the Bitrate: 32, 48, 64, 96 or 128 Kbps.
6. Select the Channel: Mono or Stereo.
7. Set the Input Volume: 1 ~ 10.
8. Set the Audio Delay (ms): 0 ~ 200.
9. Click **SAVE** to apply your settings. A small confirmation dialogue appears in the bottom right corner.



Make sure to **enable audio** and to click at the **audio** button on the bottom of the "Preview page" of the WebGUI.

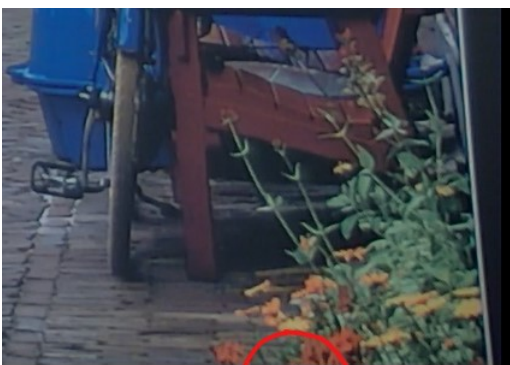



## VIDEO

You can use the VIDEO tabs (described below) to define your settings for the video output, including the main settings of the camera's OSD.

### VIDEO - Video Encoder

Figure 18: WebGUI > VIDEO > Video Encoder

The Video Encoder settings are listed below.

Video Encoder Option	Main Stream	Sub Stream
Compressed Format	MJPEG/ H.264/ H265	MJPEG/ H.264/ H265
Profile	BP/ MP/HP	BP/ MP/HP
Image Size	3840x2160/ 1920x1080/ 1280x720/	1920x1080/ 1280x720/ 720x480/ 640x480/ 640x360/ 320x240
Rate Control	CBR (constant bit rate) / VBR (variable bit rate) depending on format	
Image quality	Fixed at 'best'	Fixed at 'better'
Bit Rate(Kb/s)	64-40960	64-40960
Frame Rate (F/s)	5-60 frames per second	5-30 frames per second
I Frame Interval	1-300	1-150
I Framemin. QP	10-51	10-51
QFactor	50	40
Streamname	live/av0	live/av1
RTSP Link	rtsp://<ip-address>/live/av0	rtsp://<ip-address>/live/av1
RTP Package	Small Package (standard MTU size, 1500 bytes) Big Package (approx. 60kb MTU size)	



NDI uses the **Main Stream** of the camera. Execute the following steps to save your settings:

1. Click **SAVE** to apply your settings. A small confirmation dialogue appears in the bottom right corner.
2. Reboot the camera if you changed RTP package.



Read this [article](#) from Youtube and the [article](#) from Facebook for setting up a correct stream, if you want to stream via Youtube or Facebook.

## VIDEO - Streaming Video

Figure 19: WebGUI > VIDEO > Streaming Video

The recommended Streaming Video settings are listed below. See for more [Streaming](#) on the website.

Stream Option	Main Stream	Sub Stream
<b>Enable</b>	Mark checkbox to enable	Mark checkbox to enable
<b>Protocol Type</b>	RTMP, SRT	RTMP, SRT
<b>Host Address</b>	192.168.5.11	192.168.5.11
<b>Host Port</b>	1935	1935
<b>Stream Name</b>	live/av0	live/av1
<b>User Name</b>	Empty is default setting	Empty is default setting
<b>Password</b>	Empty is default setting	Empty is default setting
<b>Password for stream encryption*</b>	Empty is default setting	Empty is default setting
<b>Crypto Key Length in bytes</b>	0, 16, 24, 32	0, 16, 24, 32



Execute the following steps to save your settings:

1. Mark the checkbox to enable and select RTMP or SRT as Protocol Type.
2. (\* in the table ) Enter a value for **Password for stream encryption** if the selected **Protocol Type** is "SRT". Note that this is the **Caller Mode**. For the **Listener Mode** see [Video - SRT](#).
3. Click **SAVE** to apply your settings. A small confirmation dialogue appears in the bottom right corner.
4. Start an video streaming application like VLC mediaplayer, Daum Potplayer etc. to stream the video.

## VIDEO - Multicast Streaming

If you want to stream your video (live) to a selective group of hosts inside a network, then multicast streaming is recommend. Multicast streaming allows you to send data (video) to a group of hosts in a network simultaneously with limited network load. For this you need a connection to a switch with the possibility for multicast streaming to send video stream. A connection of the clients to this multicast switch is needed to request the video stream from the switch. See the picture below:

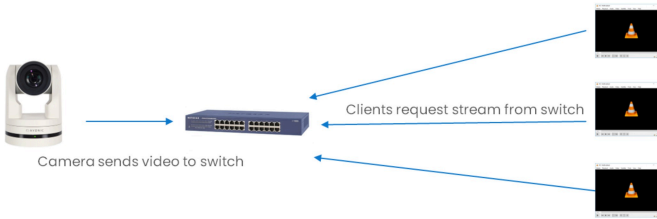

Next to multicast, there is also unicast allowing you to stream video (via RTSP) to one single users IP address. For more information read also [Unicast, Multicast and Broadcast](#) on the website.

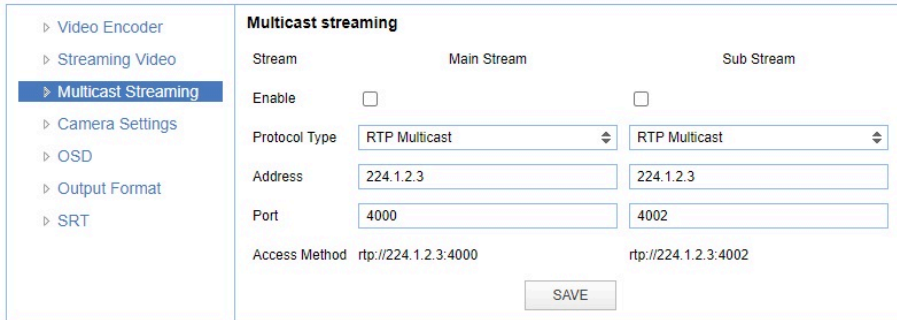

Figure 20: WebGUI > VIDEO > Multicast Streaming

The recommended Multicast Streaming settings are listed below.

Stream Option	Main Stream	Sub Stream
<b>Enable</b>	Mark checkbox to enable/ disable	Mark checkbox to enable/ disable
<b>Protocol Type</b>	RTP Multicast/ TS Multicast/ TS Unicast	RTP/ TS Multicast/ TS Unicast
<b>Address (multicast)</b>	224.0.0.0~ 239.255.255.255	224.0.0.0~ 239.255.255.255
<b>Address (unicast)</b>	Specify the IP address to which you want the Unicast stream pushed.	
<b>Port</b>	4000 (default)	4002 (default)
<b>Access Method</b>	rtsp://224.1.2.3:4000	rtsp://224.1.2.3:4002



Click **SAVE** to apply your settings. A small confirmation dialogue appears in the bottom right corner.

## VIDEO - Camera Settings

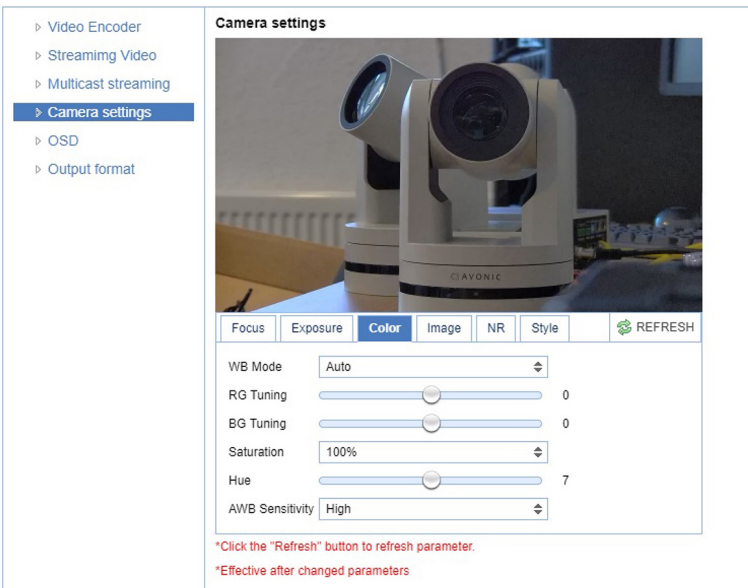

Figure 21: WebGUI > VIDEO > Camera Settings



Execute the following steps to define your camera settings:

1. Use the **Camera Settings** tabs (described below) to change the OSD settings as if you are using the remote control.
2. If you have changed a value with the remote control, update the WebGUI using the **REFRESH** button.



A picture is shown **ONLY** if the main video stream is set to H264.

## Focus

- ▷ Video Encoder
- ▷ Streaming Video
- ▷ Multicast Streaming
- ▷ Camera Settings
- ▷ OSD
- ▷ Output Format
- ▷ SRT

**Camera settings**



Focus

Exposure

Color

Image

NR

Style

CCM

REFRESH

Focus Mode

AF-Zone

AF-Sensitivity

\*Click the "Refresh" button to refresh parameter.

\*Effective after changed parameters

Figure 22: WebGUI > VIDEO > Camera Settings > Focus

The Focus settings are explained below.

### Focus Mode

<b>Auto</b>	The camera determines the focus position and will adjust to the contents of the filmed object.
<b>Manual</b>	The user is able to set a fixed focus position manually. This can be useful when the contents of the filmed object are not clear towards the background and the autofocus has difficulty finding the correct focusing.
<b>One-push</b>	The camera will focus once and will keep the focus in that position until another focus command is sent.

### AF-Mode

This setting defines the area where the autofocus is aimed at. Note that this setting is not visible at manual focus.

<b>Front Focus:</b>	Focus close to the camera has priority. If there is no object or person to focus on from close, the camera will focus on an object or person further away.
<b>Back Focus:</b>	Focus far from the camera has priority. If there is no object or person to focus on from far away, the camera will focus on an object or person closer to the camera.
<b>Meeting:</b>	For general meeting scenarios. Focus straight before the camera, but focussing in the whole room or stage is considered.
<b>Moving Objects:</b>	For focussing in the whole room or on stage, but re-focussing is done when the object or person is moving around.
<b>Center Focus:</b>	Focus straight forward at the middle of the room or on stage and re-focussing is done when the object or person moves.

## AF-Sensitivity

Sets the level of speed with which the autofocus responds. This can be useful if you have people walking through the picture. If the setting is 'High', the camera will respond immediately. If the setting is 'Low' or 'Medium', the camera will not react to sudden and short changes. The AF-Sensitivity is only visible with Focus Mode > Auto.



Note that in some cases the autofocus will have some difficulties to focus. We strongly recommend to focus manually to avoid autofocus issues. See also [Troubleshooting/ Image](#) in this manual.

## Exposure

If you click in the field after the option 'mode', you will see that you have the following Exposure options: Auto, Manual, SAE, AAE and Bright. These options are described below.

### Auto Exposure Mode

In Automatic exposure mode, the camera determines the iris and shutter settings. See the settings below:

### EV (Exposure Value): ON/OFF and Level

If the light conditions require this, you can create a quick adjustment to your current exposure settings without actually changing the fundamental values like iris and shutter.



Take care to not 'overdo' the settings or the picture will become washed out bright or too dark.

### BLC (Back Light Compensation): ON/OFF

Compensation for having to film against bright light directly into the lens. See the pictures below:

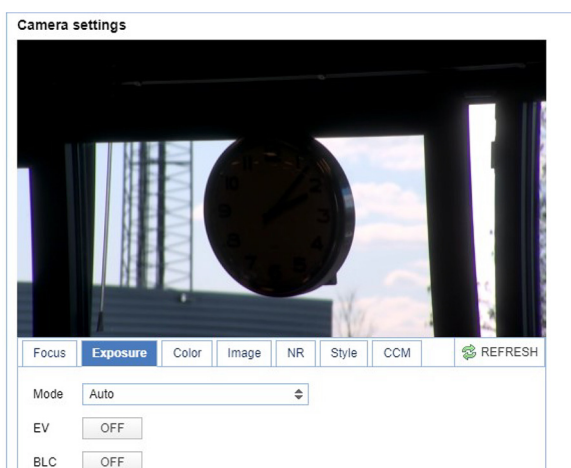

Figure 23: Camera Settings > Auto Expo (BLC OFF)

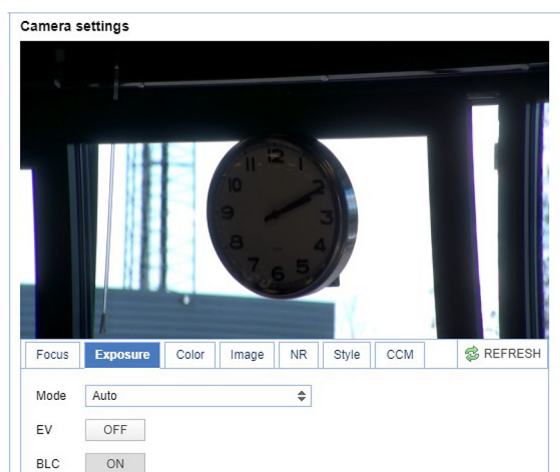

Figure 24: Camera Settings > Auto Expo (BLC ON)

## Flicker

This setting handles the flickering of artificial lighting in its operating space. Options are 50Hz, 60Hz and OFF. See for more [Anti-flickering](#) on the website.

## G.Limit

Gain limit is the maximum level of artificial brightness and contrast that the camera can automatically add to the image. This setting will make a significant difference to the overall picture.



This setting add noise to the picture in dark areas and produce a washed out, greyish picture.

## DRC

Dynamic Range Compression has a similar effect on the picture as the above mentioned gain limit. The DRC works by compressing the natural dynamic range of the image by taking out the darkest and lightest parts. This can be a particular helpful setting when the light conditions are challenging. The differences should be clearly visible in dark parts of the image, as they will become lighter/more grey as the level of DRC increases.

## Manual Exposure Mode



Figure 25: WebGUI > VIDEO > Camera Settings > Manual Exposure Mode

In Manual exposure mode, you can manually set the shutter, Iris and DRC options.

### Shutter

The shutter setting determines the amount of time per second that the sensor is exposed. The range of the shutter speed setting is 1/25th of a second (40 milliseconds) to 1/10000th of a second (0.1 milliseconds). If you shoot a video with a shutter time of 1/25th of a second, you can imagine that the video becomes blurry and overexposed. The faster the shutter is set to open and close, the sharper your filmed object will become. However, the amount of light that falls onto the sensor is also diminished. A higher shutter setting comes in handy when you have regularly a fast moving person or object before the camera. Otherwise keep the shutter as low as possible.



If you are inexperienced or if the light conditions change a lot, it's best practice to keep the camera on the automatic exposure setting.

### Iris

The Iris is a part of a lens that regulates the amount of light that passes through the lens and onto the sensor, by altering the diameter of the hole through which the light enters. The diameter of the hole is measured in **F-stop** value. A higher value results in less light, while a lower setting results in more light. This setting affects the length of the depth of field. The higher F-stop you use, the deeper your depth of field. Reason: the smaller the aperture, the more focused the light beams will be, resulting in a more focused image. This means that the light beams are so "concentrated" that the focus point of the lens is at an area far from the lens (making the camera in the picture sharp), but the object at the front (the IR remote control) will be not in the focus area and become out of focus. A higher F-stop value comes in handy when the filmed person or object is in great distance from the camera (and zooming in more is not possible). At the other side the lower F-stop values are useful when the filmed person or object is close to the camera.

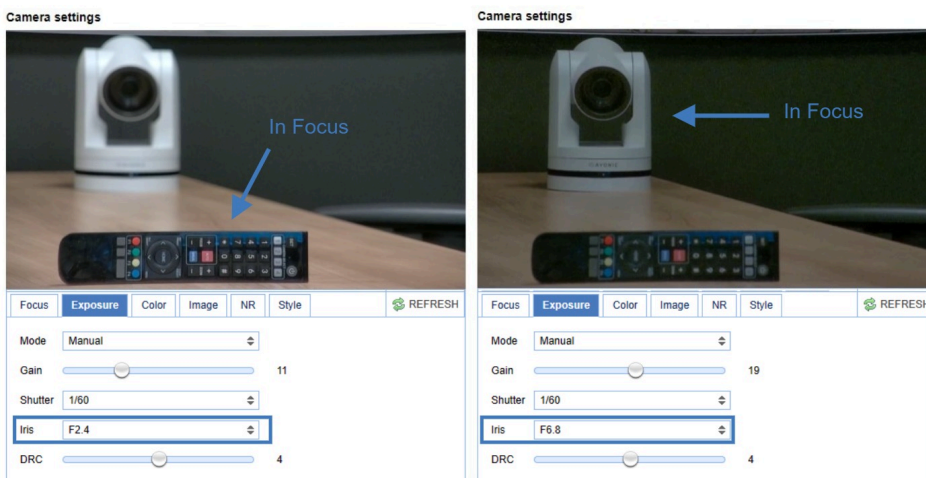

Figure 26: Exposure > Manual with Iris F2.0 (left) and Iris F6.8 (right)

### DRC

Dynamic Range Compression has a similar effect on the picture as the above mentioned gain limit. The DRC works by compressing the natural dynamic range of the image by taking out the darkest and lightest parts. This

can be a particular helpful setting when the light conditions are challenging. The differences should be clearly visible in dark parts of the image, as they will become lighter/more grey as the level of DRC increases.

### SAE Mode (Shutter Auto Exposure)

The shutter speed is user-adjustable in this mode. The camera automatically decides the best Iris F-stop value for an optimal exposure setting. Note that this setting will come with a cost. The higher the shutter speed, the more sharp the picture become, but also the more dark the picture will be.



The shutter speed is the amount of time that each frame of the sensor has been exposed to light.

To compensate poor lighting conditions, it is possible to adjust the Gain and DRC (Dynamic Range Compression). The DRC works by compressing the natural dynamic range of the image, taking out the darkest and lightest parts. This can be a particular helpful setting when the light conditions are challenging. The differences should be clearly visible in dark parts, as they will become lighter / more grey as the DRC increases.

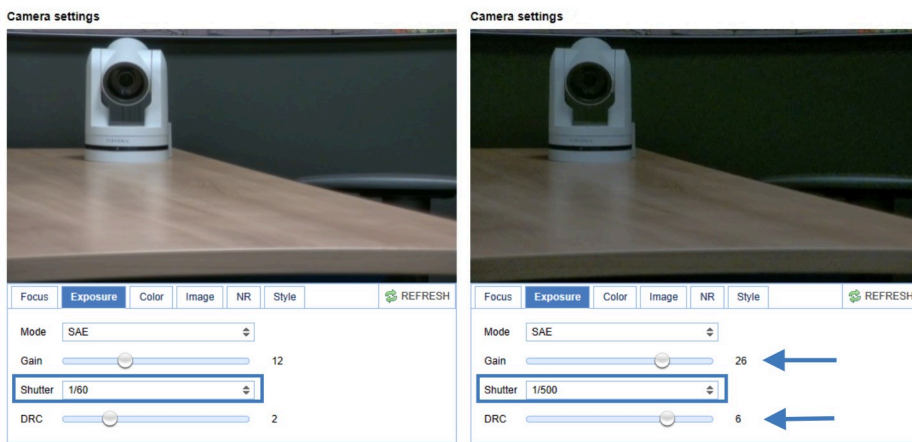

Figure 27: Exposure > Shutter speed at 1/60 (left) and 1/500 (right)

### AAE Mode (Aperture Auto Exposure)

In this mode you can set the Iris F-stop value (aperture). The higher the F-stop value, the deeper the depth of field you will become in the picture. The camera will automatically set the shutter speed based on the Iris F-stop set by the user. As the camera determines the preferable shutter speed, it is possible to turn the anti flicker setting to the required 50Hz or 60Hz to eliminate the effects of a shutter functioning at 1/50th of a second, for example. Like, with the shutter speed in SAE mode, there is a cost. The higher the F-stop value, the more dark the picture become. To compensate this you can set both the Gain Limit and the DRC.

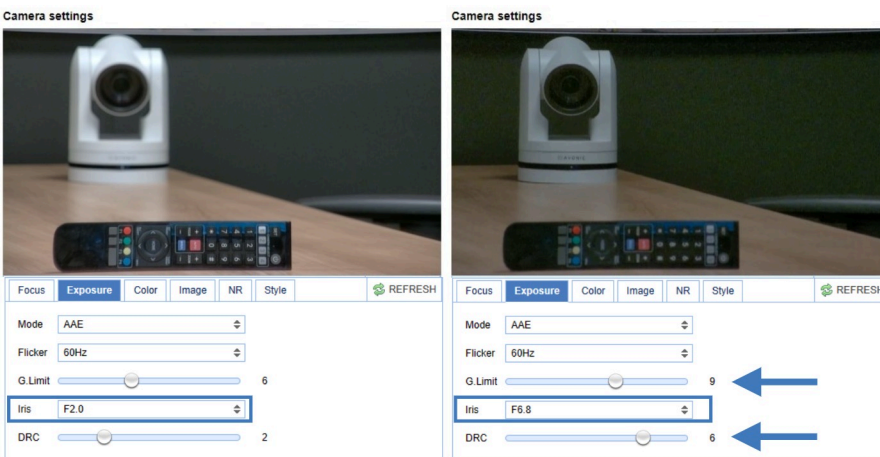

Figure 28: Exposure > AAE with Iris F2.0 (left) and Iris F6.8 (right)

## Bright Mode

This mode is to try and create a decent image when the light conditions are exceptionally poor.



Figure 29: WebGUI > VIDEO > Camera Settings > Bright Exposure Mode

In this mode, you should keep the Bright level, Gain limit and DRC as low as possibly acceptable to avoid getting too much noise in the picture. If the level of noise in the image becomes unacceptable, you can use noise reduction to smooth the picture over.

## Color

The color modes inside the camera are designed in such a way that the video output of the camera can match the current light conditions to produce accurate colors. There are several automatic preset modes and a manual mode to set the colors to the preference of the user.

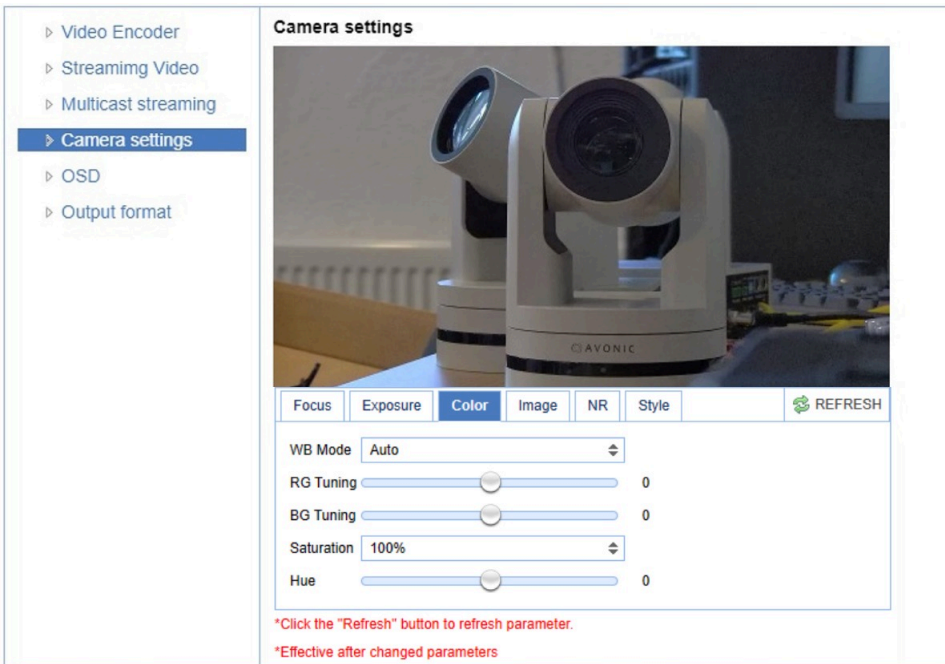

Figure 30: WebGUI > VIDEO > Camera Settings > Color

The settings are listed below.

<b>WB mode</b>	The camera continuously measures and defines the light conditions and acts accordingly (Auto). In this mode, there are some adjustments that can be made to tune the image to the preference of the user (in manual or when the white balance is set to a specific value).
<b>RG Tuning</b>	Red Gain Tuning, increase or decrease red.
<b>BG Tuning</b>	Blue Gain Tuning, increase or decrease blue.
<b>Saturation</b>	How saturated the image's colors are. 0% would produce a black and white image.
<b>Hue or tint</b>	The balance between green and red. -15 is green, 15 is red, 0 is natural color.



## Image

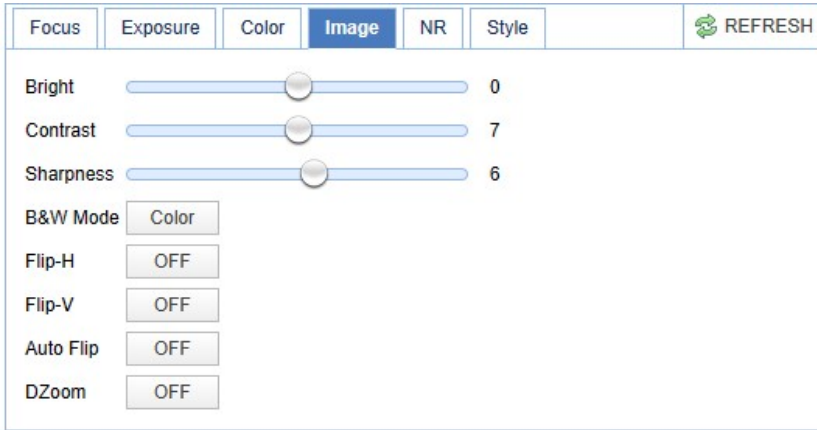

Figure 31: WebGUI > VIDEO > Camera Settings > Image

These are settings that have an effect on the image post-processing. Basically, these settings are all artificial: they don't affect the optical parts of the camera itself. The settings are listed below.

<b>Bright</b>	The amount of detail that is visible in darker areas of the image. Be careful not to set this setting too high, as you will see that the image becomes 'milky-white'!
<b>Contrast</b>	The amount of detail that is visible in lighter areas of the image.
<b>Sharpness</b>	Artificial contrast, be careful not to set this too high as it will create a sort of 'halo' around sharp edges of filmed objects. The setting of sharpness coincides with the setting of noise reduction.
<b>B&amp;W Mode</b>	Black and White Mode makes the picture black and white.
<b>Flip-H, Flip-V, Auto flip</b>	The Flip-H mode turns the picture horizontally, while the Flip-V mode turns it vertically by 180 degrees. When Auto Flip is on, the camera will automatically flip the picture horizontal and vertical.
<b>DZoom</b>	This is the digital zoom of the camera. With this feature ON, you can zoom in slightly further on the filmed object. Setting this feature OFF when you are already zoomed in to the max, the camera will (automatically) zoom out a few times until it reached the max zoom level <b>without</b> the (extra) digital part.

## NR (Noise Reduction)

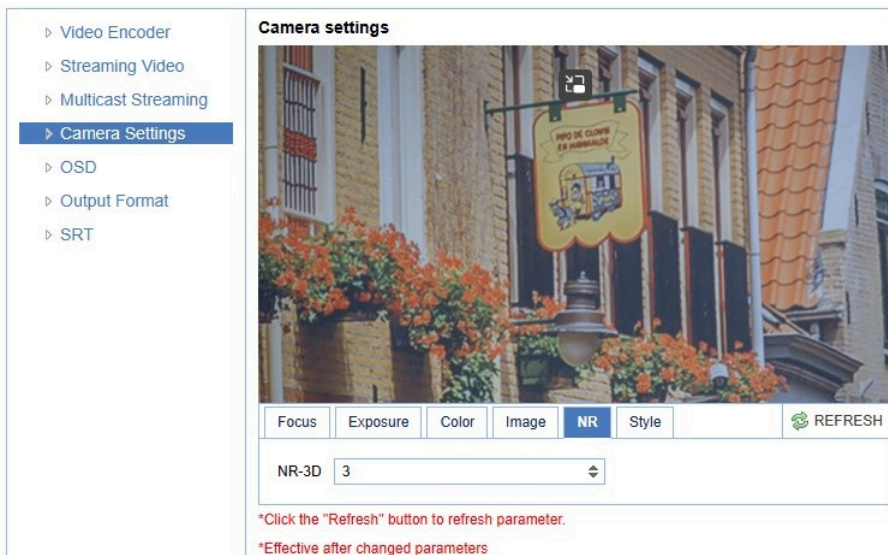

Figure 32: WebGUI > VIDEO > Camera Settings > NR

Noise reduction can be used to soften the image when noise is present due to poor lighting conditions. The higher the amount of noise reduction, the softer the image will get, ultimately resulting in loss of details.

Be careful when adjusting the noise reduction, as it can take away the natural 'crispness' of the image. You will lose the natural 'crispness' of the image, if you set the dynamic contrast and gain too high (this will cause more noise). Better practice is to add light to the filmed object.

### Style

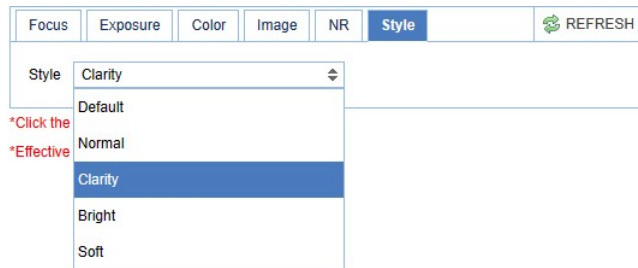

Figure 33: WebGUI > VIDEO > Camera Settings > Style

Here, you can choose the style you want, such as **Default** (standard setting), **Normal** (which makes the picture more 'natural'), **Clarity** (makes the picture more clear), **Bright** (which makes the picture more bright) and **Soft** (which softens the picture).

### VIDEO - OSD

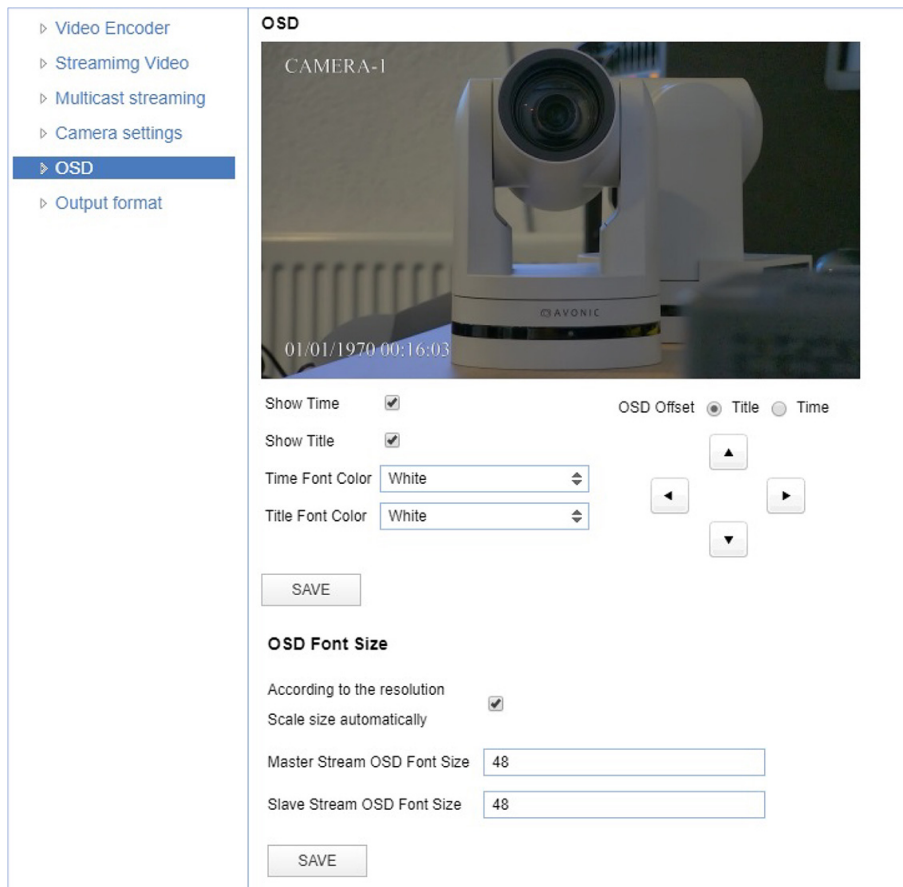

Figure 34: WebGUI > VIDEO > OSD

In this area, you can put a camera name and time as overlay on the IP stream (the overlay feature is exclusively available on the IP stream, not on other outputs).



**Note that only the output of the camera will be shown with the main stream set to H264.**

## Fields

You can enable or disable **Show Time** and **Show Title** can be enabled or disabled by marking or unmarking the checkbox next to the respective setting (the time and name settings can be found under the tab **SYSTEM**, sections **Attributes** and **Time**).

You can use the dropdown menus **Time Font Color** and **Title Font Color** to set the desired font colors.

You can use the directional arrows on the right to move the title and time to the preferred position on the screen.

## OSD Font Size (related to Camera Name and Time)

You can use **Scale size automatically** for both main stream and sub stream. If checked, the camera name and time overlay will always scale with the image, keeping the proportions intact.



Click **SAVE** to apply your settings. A small confirmation dialogue appears in the bottom right corner.

## VIDEO - Output Format

Figure 35: WebGUI > VIDEO > Output Format

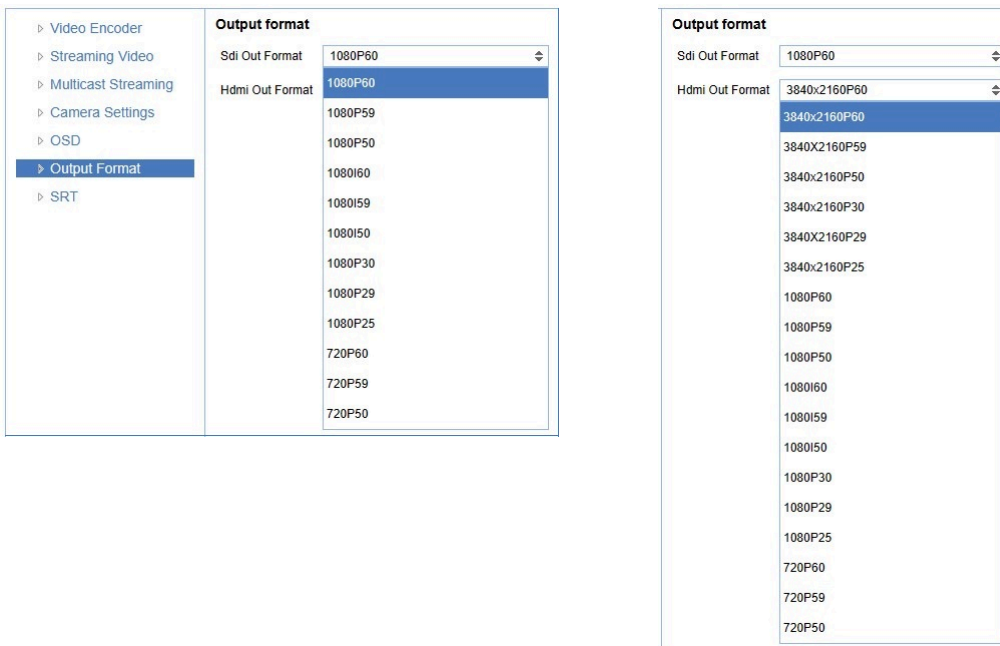

This setting is related to the output resolution and frame rate on the HDMI and SDI connectors. SDI resolution between 720p50 - 1080p60, HDMI resolution between 720p50 - 3840x2160p60 . For the 4K resolutions you need a 4K compatible monitor.

Use the WebGUI to set the resolution of the main and sub IP streams. The resolution of the USB output is determined by the computer that is connected to it.



Click **SAVE** (not shown here) to apply your settings. A small confirmation dialogue appears in the bottom right corner.



Video output over IP cannot be a higher resolution than the physical SDI/HDMI output setting.

## VIDEO - SRT

These settings are related to SRT streaming protocol. With SRT you can define the port, passkey and encryption bit.



When not using Encryption, please make sure to set the **Crypto key length** to 0.

SRT Listener Mode and Caller Mode are both supported. You can define the Listener mode settings here, whereas the Caller Mode settings can be defined in the [Streaming Video tab](#). See the respective figures below for the Listener and Caller Mode Settings, respectively.

Figure 36: WebGUI > VIDEO > SRT (Listener Mode)

Figure 37: WebGUI > VIDEO > Streaming Video (Caller Mode)

## NETWORK



Use the tabs on the NETWORK screen to define the appropriate **Port**, **Ethernet** and **DNS** settings.

### Port Settings

Figure 38: WebGUI > NETWORK > Port Settings

You can define specific ports for the different streaming outputs and protocols the camera supports.



**Make sure these settings don't interfere with other uses and services on the same network.**



Click **SAVE** to apply your settings. A small confirmation dialogue appears in the bottom right corner.

## NETWORK - Ethernet

In this section, you can specify the IP settings for the Ethernet adapter.

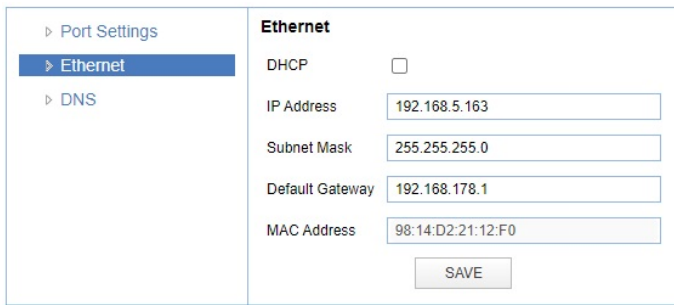

Figure 39: WebGUI > NETWORK > Ethernet



Execute the following steps to save your settings:

1. Click **SAVE** to apply your settings. A small confirmation dialogue appears in the bottom right corner.
2. Reboot the camera.

## NETWORK - DNS

Here, you can specify the **Preferred** and **Alternative DNS Server**.

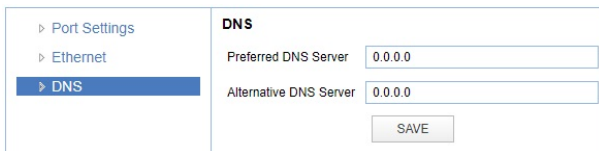

Figure 40: WebGUI > NETWORK > DNS



Click **SAVE** to apply your settings. A small confirmation dialogue appears in the bottom right corner.

## SYSTEM

You can use the **SYSTEM** tabs (described below) to define the desired system settings.

### Attributes

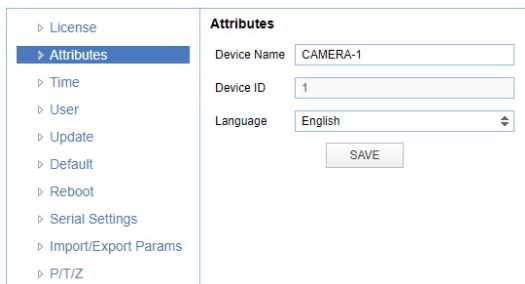

Figure 41: WebGUI > SYSTEM > Attributes

Specifying a specific device name to be displayed in the OSD can be useful when using multiple cameras on the same LAN. The Device-ID is always 1 (addressing is done via IP). The language cannot be changed.



**The ONVIF protocol does NOT accept spaces in the camera name.**



Click **SAVE** to apply your settings. A small confirmation dialogue appears in the bottom right corner.

## Time

Figure 42: WebGUI > SYSTEM > Time

You can **manually** set the time and date, or synchronize the time and date via a computer or an external server on the LAN or WAN.



Either click **SAVE** to apply your manual settings, or **SYNC** to synchronize the time and date.

## User

Figure 43: WebGUI > SYSTEM > User

You can define different users with specific permission levels and different username / passwords combinations. There are 2 levels of users: **administrators** with access to all features, and **user-1 and user-2** with access to the preview and PTZ controls. Click **SAVE** to apply your settings.

It is also possible to fill in automatically your user name and password using your browser. To do this save your username and password in your browser, enable the HTTP Basic Authentication and click **SAVE**. Read also [HTTP Basic Authentication](#) on the website for more.



Note that, if you enable the HTTP Basic Authentication (and save it), you **cannot** log out in the traditional way! To log out from the WebGUI, disable this option and **refresh** your browser. See the picture above.

## Update

Figure 44: WebGUI > SYSTEM > Update

By default, this screen shows a readout of the current firmware versions. The **Update file** provides a firmware upgrade functionality via this screen. When the camera is done uploading and processing the update, it will automatically reboot.



Execute the following steps to perform a firmware upgrade.

1. Click **Choose File** to select the firmware update file.
2. Click **UPGRADE** to start the firmware upgrade wizard.
3. Follow the steps in the wizard. Wait until the process finishes and reboots.
4. Refresh your browser and log in again after the reboot.

## Default

If necessary, you can perform a factory reset. This restores all default settings.

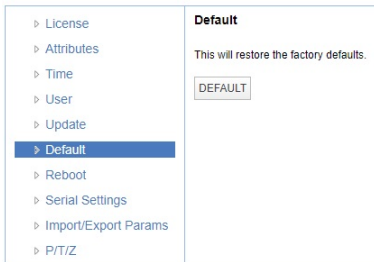

Figure 45: WebGUI > SYSTEM > Default



Click on the button **This will restore the factory defaults** to perform a factory reset. When completed, the camera automatically reboots. The camera will be ready for use again after the boot cycle.

## Reboot

If necessary, you can manually perform a camera reboot. It is also possible to create a new reboot schedule to automatically reboot the camera at any time you want.

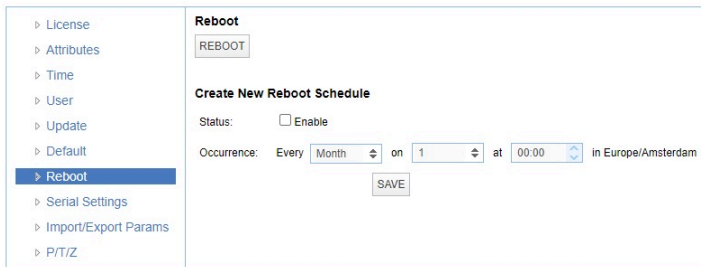

Figure 46: WebGUI > SYSTEM > Reboot



Click on the button **Reboot** to reboot the camera. It will be ready for use again after the boot cycle.



Follow instructions below if you want to create a new reboot schedule.

1. Enable "create new reboot: status".
2. Select at "occurrence" the month and day and select the time you want to reboot the camera. Take note that **Amsterdam/ European timezone** is used!

## Serial Settings

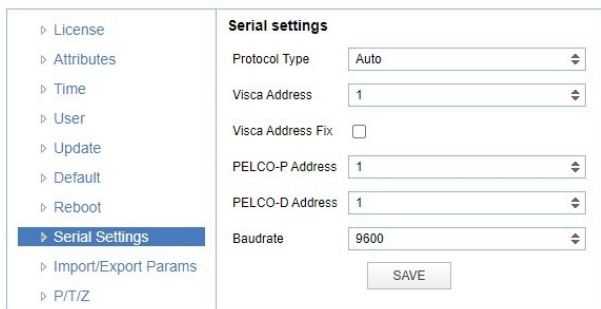

Figure 47: WebGUI > SYSTEM > Serial Settings

You can choose the preferred protocol to use and the accompanying address to go with it. Or you can select the default protocol type 'Auto' to let the camera detect which protocol is being used. Note that **addressing** is still needed, even with the automatic setting.



Click **SAVE** to apply your settings. A small confirmation dialogue appears in the bottom right corner.

## Import/Export Parameters

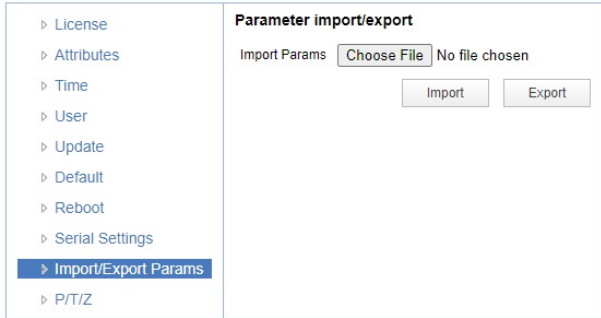

Figure 48: WebGUI > SYSTEM > Import/Export

The cameras have the ability to import or export a configuration.



Execute the following steps to import or export your configuration parameters:

1. Select the appropriate button to import or export your configuration parameters.
2. Follow the steps in the wizard that appears.



**The exported settings do NOT include any presets that are stored in the camera!**

## Focus log export

You can download a log file of the focus information of the camera.



Follow the instructions below:

1. **Right click** with your mouse on the DOWNLOAD button.
2. Select SAVE LINK AS and click SAVE. The text file is available after downloading in your download directory of your computer.

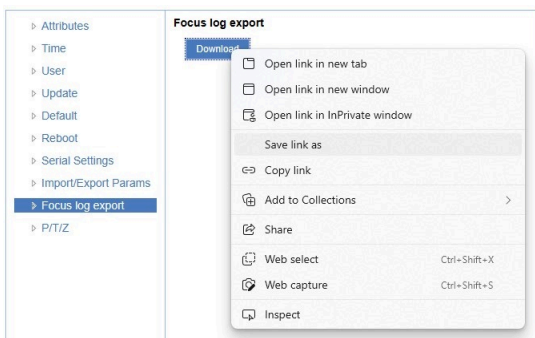



## P/T/Z

<ul style="list-style-type: none"> <li>▸ License</li> <li>▸ Attributes</li> <li>▸ Time</li> <li>▸ User</li> <li>▸ Update</li> <li>▸ Default</li> <li>▸ Reboot</li> <li>▸ Serial Settings</li> <li>▸ Import/Export Params</li> <li style="background-color: #0070C0; color: white;">▸ P/T/Z</li> </ul>	<p><b>P/T/Z</b></p> <p>PTZ Speed <input checked="" type="radio"/> Slow <input type="radio"/> High</p> <p>Speed by zoom <input checked="" type="checkbox"/></p> <p>Image Freezing <input type="checkbox"/></p> <p>Low Power Mode <input checked="" type="checkbox"/></p> <p>Enable/Disable Infrared Receiver <input checked="" type="checkbox"/></p> <p>Zoom Speed <input type="text" value="8"/></p> <p>Preset Pan Speed <input type="text" value="25"/></p> <p>Preset Tilt Speed <input type="text" value="21"/></p> <p>Preset Zoom Speed <input type="text" value="8"/></p> <p style="text-align: center;"><input type="button" value="SAVE"/></p>
---	--

Figure 49: WebGUI > SYSTEM > P/T/Z

In this window, you can define various P/T/Z settings for your camera. These are:

<b>PTZ Speed</b>	This increases the maximum pan and tilt speed. This can be useful in a conference system where quick action is necessary. The camera will produce slightly more noise when this setting is set to 'high'.
<b>Speed by zoom</b>	This mode affects PTZ speed when the camera is zoomed in to its max. If you move the stick of your controller when this mode is disabled, it will move too fast to control it. Enabling reduces this speed in relation to the current zoom factor.
<b>Image Freezing *</b>	You can freeze the image when the camera moves from one preset to another preset when you use your (remote) controller.
<b>Low Power Mode:</b>	The camera will go in stand by mode to reduce its power when this mode is enabled. In order to reduce the power the camera uses, the camera will shut down the IP Port. To activate the camera again, use a serial connection or the IR Remote to set off the Low Power Mode.
<b>Enable/ Disable Infrared Receiver:</b>	It is possible to enable/disable the Infrared Receiver. Note that, when you disable the Infrared Receiver and the Low Power Mode is enabled, it will <b>NOT</b> be possible to activate the camera again using the IR Remote Control!
<b>Zoom Speed</b>	You can set the speed to which the camera will zoom in to the image. The higher the number, the faster the camera will zoom in. This works only when the remote controller is used to control the camera.
<b>Preset Pan, Tilt and Zoom Speed</b>	This mode affects the speed to which the camera is switching from one preset to another when you use your (remote) controller. The higher the number, the faster it will switch.



\* If you are using audio during streaming, put it first **OFF** before freezing the image! Freezing the image could produce a paused audio output on the IP Stream. This leads to (audio) stuttering. The video stutters when it is re-engaged, but this is rather easily solvable by putting the iFrame value at 4 or 5 times per second, that is quick enough to counteract the video stutter.

## MJPEG Snapshot

The Avonic CM93 camera is equipped with a MJPEG snapshot feature to, for example, implement into third party software. Every time the page is refreshed, the picture will be updated.



To access the MJPEG snapshot feature, use the following format: <http://IP/img/capjpg/snapshot.jpg>. See also [MJPEG Snapshot](#) on the website.

## Using the Remote Control

The Product is provided with an IR Remote Control for full control of the camera and use of the OSD menu.

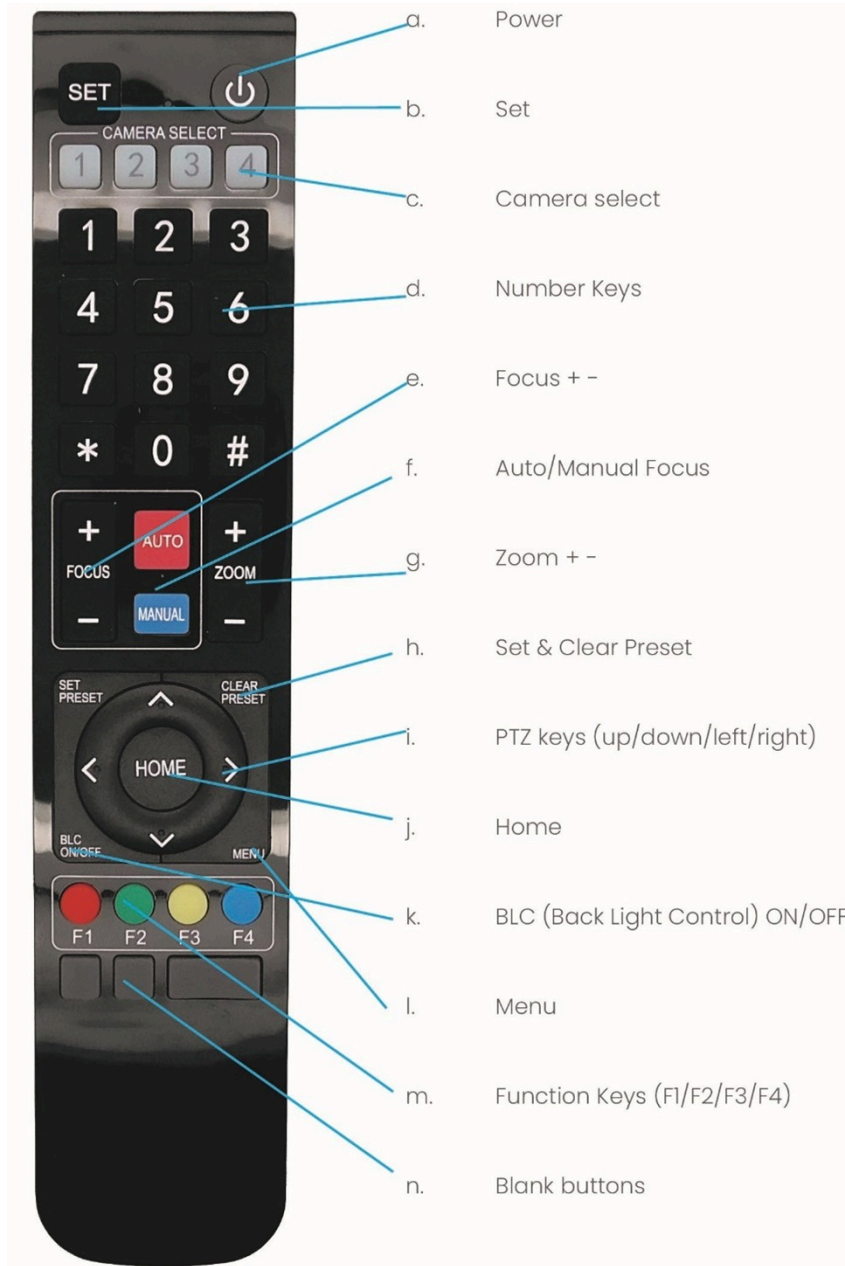

Figure 50: Remote Control

The various options (a. through n.) are described below.

### a. Power



1. Put two AAA 1.5v batteries in the IR Remote Control. Use **ONLY** this type of batteries! Using other type of batteries can damage the IR Remote Control.
2. Press the **Power** button to turn on the camera. If the position preset '0' has been stored, this will be called after initialization.
3. Press the **Power** button again to turn the camera off. It will turn to the back when turned off, this is called the "privacy mode".

### b. Set

This button has **no** function with this camera.

### c. Camera Select

Up to 4 different cameras can be controlled with one IR remote Control. You can use the **camera select** buttons [1,2,3,4] to select the IR channel that the remote control is using. The default camera IR channel is 1.



1. To control a camera on first use, select camera 1 (IR channel 1) on the remote control.
2. To control a second camera, you first need to change the IR channel stored in the camera from 1 to 2. Then do the following:
  - a. First turn off the other cameras in the room you don't want to change, to prevent that other cameras also get changed accidentally.
  - b. Select camera 1 on the remote control, because the camera is still configured to listen to IR channel 1.
  - c. Press [\*]→[#]→[F2] to change the IR channel inside the camera to IR channel 2. The camera will confirm this on the screen.
  - d. Select camera 2 on the remote control to control this camera.

Key Combinations: (Default IR address is 1)

[*]→[#]→[F1]	Camera Address No. 1
[*]→[#]→[F2]	Camera Address No. 2
[*]→[#]→[F3]	Camera Address No. 3
[*]→[#]→[F4]	Camera Address No. 4



The Function buttons F1, F2, F3 and F4 are the colored buttons on the remote.

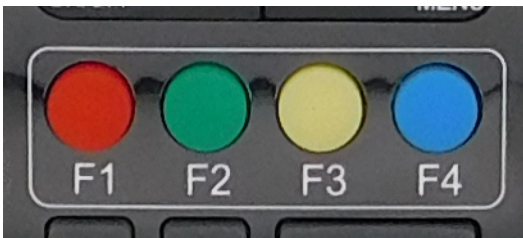

Figure 51: Function Buttons on Remote

### d. Number Keys

The number keys are used to call presets.



Press the number [0-9] of the desired preset and the camera will respond accordingly (See 'h' on how to set & clear presets).

### e. Focus + -



1. Push the button [manual focus] first before using the focus buttons.
2. Focus the camera with the [+] and [-] button.  
If the camera does not respond, check if the camera is set to auto-focus.

### f. Auto/Manual Focus



Set the camera to 'auto focus' or 'manual focus'.

If the camera is configured to 'auto focus', the buttons [Focus + -] are disabled.

If the camera is in 'manual focus' and the **Zoom** buttons are used, the camera automatically switches to 'auto focus'.

### g. Zoom + -



Zoom the camera with these buttons.

## h. Set & Clear Preset

A preset is a specific position of a camera that you save in the camera. A preset is assigned to a number from 0-9.



1. To set a preset, first point the camera in a specific directing and a specific zoom position.
2. Assign the position to a number with the button **Set Preset**.
3. You can call the preset by pressing one of the numbers 0-9 on the remote control.

Set Preset: [SET PRESET]→[<number>]

Call Preset: [<number>]

Clear Preset: [CLEAR PRESET]→[<number>]

If the position preset '0' has been stored, this position will be called after initialization.



**Use ONLY presets between 0-9 when using the Remote Control. For presets 10 or higher you need a serial or IP connection!**

## i. PTZ Keys (up/down/left/right)



Use these keys to move the camera in the desired direction.

## j. Home



If you use this key, the camera will automatically turn to its start up position: the camera will zoom out and turns to a position with the lens straight forward. This affects only the Pan, Tilt and Zoom position and NOT the focus level of the camera, or exposure and white balance settings!

## k. BLC ON/OFF



Use this key to enable / disable the Back Light Compensation feature.

## l. Menu



1. Use the **Menu** button to open the **On Screen Display (OSD)** menu. This menu is visible on the HDMI/SDI output.
2. If the menu is not in English, press [\*]→[#]→[4] to change the Menu language into English.

## m. Function Keys (F1/F2/F3/F4)

Used to configure the IR channel of the camera. See '**c. Camera Select**' above for instructions.

## n. Blank Buttons

These buttons have NO function with this camera.

## Other Key Combinations

The following key combinations on the Remote Controller have specific functions. These are:

Combination	Function
[*] → [#] → [4]	Menu set to English
[*] → [#] → [6]	Restore factory defaults
[*] → [#] → [9]	Flip switch (just temporary flip to view the image flipped)
[*] → [#] → [Auto]	Enter into the aging mode, only for quality control purposes
[*] → [#] → [Manual]	Restore the default username, password, and IP address
[#] → [#] → [#]	Clear all presets
[#] → [#] → [0]	Switch the video format to 1080p60*
[#] → [#] → [1]	Switch the video format to 1080p50*
[#] → [#] → [2]	Switch the video format to 1080i60*
[#] → [#] → [3]	Switch the video format to 1080i50*
[#] → [#] → [4]	Switch the video format to 720p60*
[#] → [#] → [5]	Switch the video format to 720p50*
[#] → [#] → [6]	Switch the video format to 1080p30*
[#] → [#] → [7]	Switch the video format to 1080p25*
[#] → [#] → [8]	Switch the video format to 4K60*
[#] → [#] → [9]	Switch the video format to 4K50*



The camera returns to the video output setting of the system select after a reboot.



**Use ONLY presets between 0-9 when using the Remote Control. For presets 10 or higher you need a serial or IP connection!**

## Tally Light Functionality

The tally light is the LED light on the front of the camera. Note that the tally light of the camera can **ONLY** be controlled through the VISCA commands. This is not possible through the WebGUI or the OSD menu of the camera. See for the commands the [VISCA commands](#) in appendix A in this manual.



## OSD Menu

Each camera is provided with an **On-Screen Display (OSD) Menu**.

This is an integrated on-screen menu that can be accessed within the camera to change specific functions that effect how the camera processes an image.

The OSD Menu is visible on the HDMI and SDI outputs.

The OSD menu can be accessed by the Remote Control or an Avonic PTZ controller. See also [How can I open the OSD menu of my camera on the website](#).

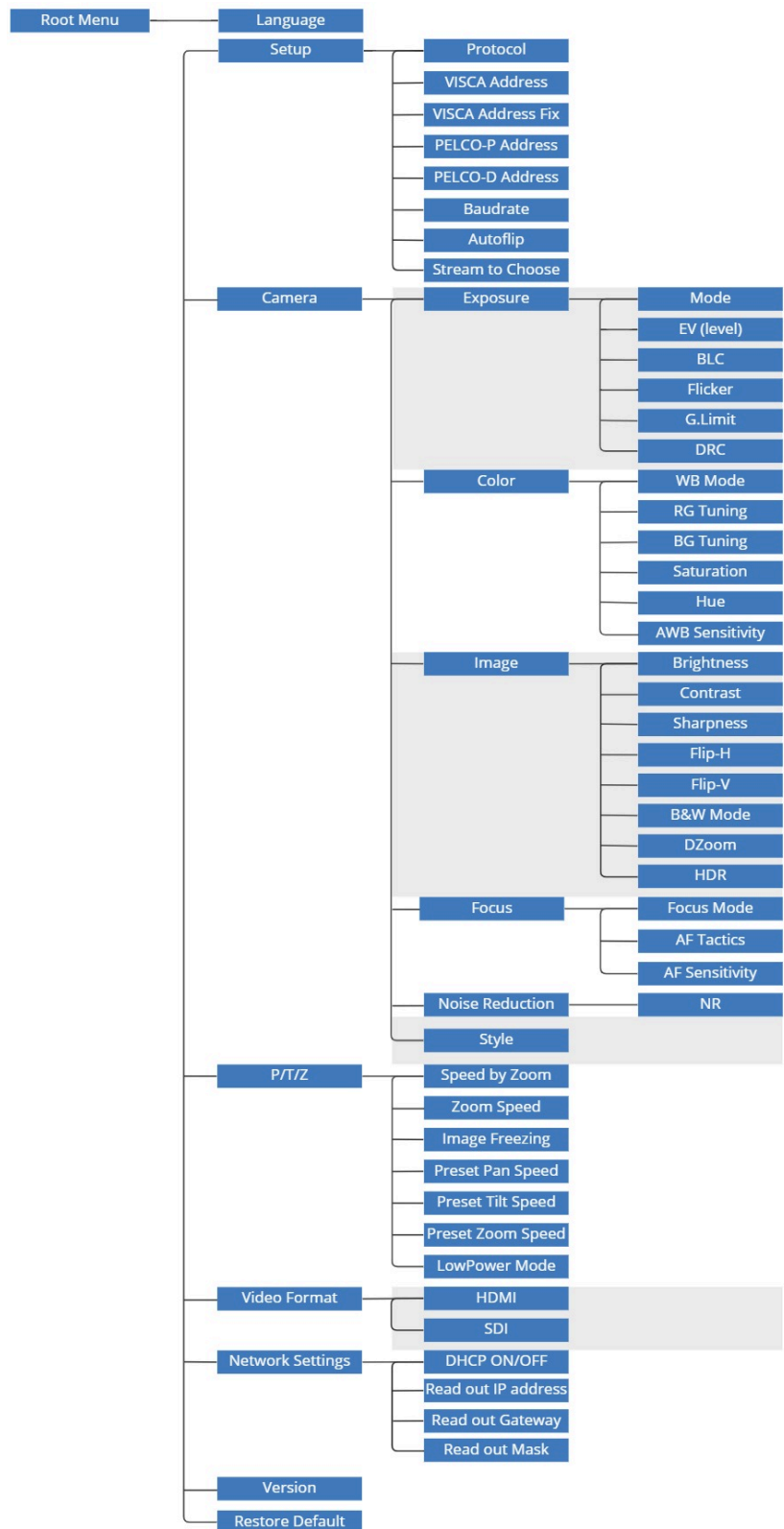

Figure 52: OSD menu structure

## 1. MENU

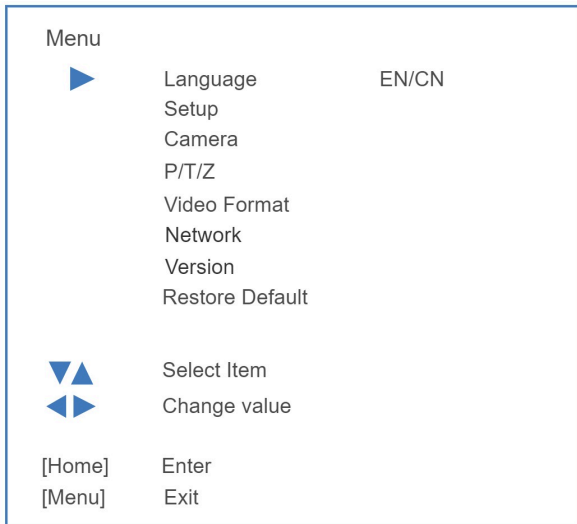

Figure 53: OSD - MENU



1. Press the **MENU** button to display the main menu on the screen.
2. Use the arrow buttons to move the cursor to the item to be set. Press the **HOME** button to enter the corresponding sub-menu.
3. Press [**◀▶**] to change settings. Press [**MENU**] again to go back.

## 2. SETUP

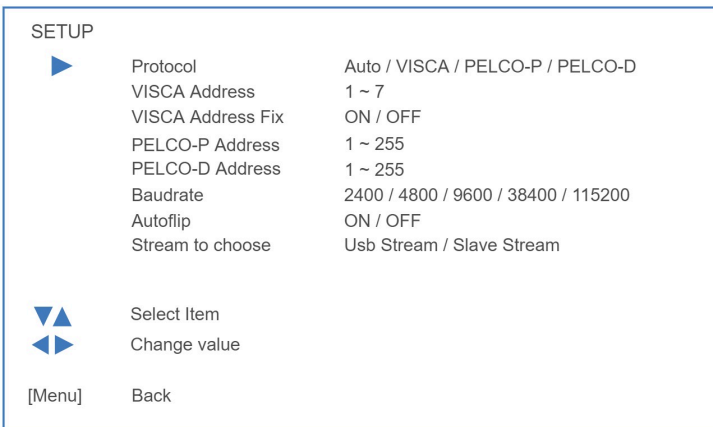

Figure 54: OSD - SETUP



If you want to use the USB port of the camera choose "USB Stream:" at "Stream to choose". This feature is only visible in the OSD menu. The Slave Stream is the secondary IP stream (see [Streaming Video](#)).

## 3. CAMERA

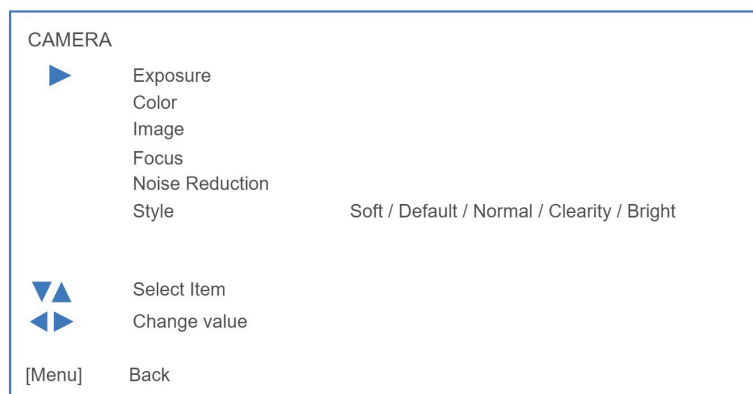

Figure 55: OSD - CAMERA

### 3.1 EXPOSURE

EXPOSURE		
▶	Mode	Auto / Manual / SAE / AAE / Bright
	Iris	F11 ~ F1.8 / Close
	Shutter	1/25 ~ 1/10000
	EV	ON / OFF
	EV Level	-7 ~ +7
	BLC	ON / OFF
	Flicker	50Hz / 60Hz / OFF
	G.Limit	0 ~ 15
	DRC	1 ~ 8 / CLOSE
▼▲	Select Item	
◀▶	Change value	
[Menu]	Back	

Figure 56: OSD - EXPOSURE

### 3.2 COLOR

COLOR		
▶	WB Mode	Auto / 2400 ~ 7100 100k increments / Manual / One Push
	RG Tuning	-10 ~ 10
	BG Tuning	-10 ~ 10
	RG	0 ~ 255
	BG	0 ~ 255
	Saturation	60% ~ 200%
	Hue	0 ~ 14
	AWB Sensitivity	Low / Middle / High
▼▲	Select Item	
◀▶	Change value	
[Menu]	Back	

Figure 57: OSD - COLOR

### 3.3 IMAGE

The Flip function can be set, although the camera has an automatically flip function.

IMAGE		
▶	Brightness	0 ~ 14
	Contrast	0 ~ 14
	Sharpness	0 ~ 15
	Flip-H	ON / OFF
	Flip-V	ON / OFF
	B&W Mode	Color / B&W
	DZoom	ON / OFF
	HDR	ON / OFF
▼▲	Select Item	
◀▶	Change value	
[Menu]	Back	

Figure 58: OSD - IMAGE



### 3.4 FOCUS

FOCUS		
▶	Focus Mode	Auto / Manual / OnePush
	AF-Tactics	Front Focus / Back Focus / Meeting / Moving Objects / Center Focus
	AF-Sensitivity	Low / Middle / High
▼▲	Select Item	
◀▶	Change value	
[Menu]	Back	

Figure 59: OSD - FOCUS

### 3.5 NOISE REDUCTION

NOISE REDUCTION		
▶	NR	1 ~ 11 / OFF
▼▲	Select Item	
◀▶	Change value	
[Menu]	Back	

Figure 60: OSD - NOISE REDUCTION

### 3.6 STYLE

STYLE		
▶	Style	Default / Normal / Clarity / Bright / Soft
▼▲	Select Item	
◀▶	Change value	
[Menu]	Back	

Figure 61: OSD - STYLE

## 4. PTZ

PTZ		
▶	Speed by Zoom	ON / OFF
	Zoom Speed	1 ~ 8
	Image Freezing	ON / OFF
	Preset Pan Speed	1 ~ 25
	Preset Tilt Speed	1 ~ 21
	Preset Zoom Speed	1 ~ 8
	LowPower Mode	ON / OFF
▼▲	Select Item	
◀▶	Change value	
[Menu]	Back	

Figure 62: OSD - PTZ

## 5. VIDEO FORMAT

VIDEO FORMAT				
▶ Video Format	HDMI		SDI	
	4K60	4KP59	1080P60	1080P59
	4K50	4KP30	1080P50	1080I60
	4K29	4KP25	1080I59	1080I50
	1080P60	1080P59	1080P30	1080P29
	1080P50	1080I60	1080P25	720P60
	1080I59	1080I50	720P59	720P50
	1080P30	1080P29		
	1080P25	720P60		
	720P59	720P50		



 Select Item  
 Change value  
 [Menu] Back

Figure 63: OSD - VIDEO FORMAT

## 6. NETWORK SETTINGS

NETWORK SETTINGS	
▶ DHCP	ON / OFF
IP-Address	xxx.xxx.xxx.xxx
Gateway	xxx.xxx.xxx.xxx
Mask	xxx.xxx.xxx.xxx



 Select Item  
 Change value  
 [Menu] Back

Figure 64: OSD - NETWORK SETTINGS

## 7. VERSION

VERSION			
▶ MCU Version	NR	Date	
Camera Version	NR	Date	
AF Version	NR	Date	

 Select Item  
 [Menu] Back

Figure 65: OSD - VERSION

## 8. RESTORE DEFAULT

RESTORE DEFAULT	
▶ Restore default?	NO / YES



 Select Item  
 Change value  
 [Menu] Back

Figure 66: OSD - RESTORE DEFAULT

## Using the System Select

The rear of the Product is provided with a System Select that can be used to manually select a video format. This System Select is important for the video quality during video recording or streaming.

See the table below for a description of the possible settings and the associated video output quality.

	0	1080p60	8	4K60 (only over HDMI)
	1	1080p50	9	4K50 (only over HDMI)
	2	1080i60	A	1080p59
	3	1080i50	B	4K30 (only over HDMI)
	4	720p60	C	4K25 (only over HDMI)
	5	720p50	D	1080p29
	6	1080p30	E	(no format)
	7	1080p25	F	Default (via OSD)

Figure 67: System Select

A few notes on the System Select:

- The setting 'F' is the **default** setting. If you set the system select to 'F', you can set the video format via the [OSD Menu](#). If you change the system select to another setting than F, it is not possible to change it again using the OSD menu! Change it back (manually) to use the OSD video format setting again.
- The **highest** video output quality 4K60 (setting '8') over HDMI and 1080p60 over SDI.
- The **lowest** video output quality is 720p50 (setting '5').



It is recommended to set up the video output through the WebGUI or the OSD Menu, because this is much easier, than selecting the [video output](#) manually. If this is not possible, you can use the System Select.



### IMPORTANT

- After changing the System Select, you need to restart the camera to take effect.
- There are five ways to select the video output of the camera (OSD / direct button combination on the remote control / WebGUI / System Select/ HTTP API "[VideoOUT](#)" command). The System Select takes priority after a reboot, except on setting F, where all the outputs are defined digitally.
- If you have made a change to the System Select, a "hard reboot" is needed. Click the Reboot button and when the reboot is finished, set the camera off and unplug all cables connected to the camera. Replug them again after you have unplugged all the cables. Start the camera again.

# MAINTENANCE

## Camera Maintenance



Take the following actions to maintain the camera:

- If you will not be using the camera for a long time, turn off the power switch and disconnect the AC powercord of the AC adaptor to the outlet.
- Use a soft cloth or tissue to clean the camera cover.
- Please use the soft dry cloth to clean the lens. If the camera is very dirty, clean it with diluted neutral detergent.



**Do not use any type of solvents, which may damage the surface.**

## Usage Precautions



Take the following precautions to ensure good image quality:

- Do not film extreme bright objects for a prolonged period of time, such as sunlight, light sources, etc.
- Do not operate in unstable lighting conditions, otherwise the produced image could be less than optimal.
- Do not operate close to powerful electromagnetic radiation, such as TV or radio transmitters, etc.

## TRANSPORT AND STORAGE

The camera must be transported in its original packaging box. Inside the box, it is recommended to wrap the camera in the original plastic bag and to place it in the protective foam.

Specific guidelines apply to the environmental temperature and humidity when operating and storing the camera.



See '**Operating humidity**' and '**Storage temperature**' in the provided **Datasheet** for the applicable values.

## DISPOSAL AND RECYCLING

In general, the term 'E-Waste' or 'Waste of Electrical and Electronic Equipment' applies to items of all types of electrical and electronic equipment and its parts that have been discarded by the owner as waste without the intention of re-use.



E-Waste, like the camera and **ALL** of its accessories, must be disposed **separately** from normal waste! See the symbol below that can be found on the product and package label:



Avonic is NOT responsible for personal data left in the settings of the camera as far as this is possible (like camera names, IP Addresses, user names, passwords etc.) **Delete** personal data **BEFORE** you send the camera back to Avonic!



Send the camera and all its accessories to [Avonic](#) or your **local distributor**. See [Package Contents](#) to see what you have to send back. Follow the instructions from the [Return Procedure](#).

Avonic outsources the disposal and recycling of its E-Waste camera materials to **Stichting Open**.



See <https://stichting-open.org/> for more information about the disposal and recycling.

# TROUBLESHOOTING

## General

-  1. Turn the camera off and on again and check if the problem persists.
- 2. If it does, restore to the factory default.

## Power Issues

-  If the camera does NOT perform a self-test and / or if the power LED is OFF:
  1. Check the net power.
  2. Check the power supply.
  3. Check the physical power button on the back of the camera.

## Image

### No image

- 
  1. Check the power of the camera and monitor.
  2. Check the quality and length of the video cable.
  3. Check if the video specifications of monitor match the specifications of the camera.
  4. Check if the Iris under **Exposure settings** is set to 'closed'.

### Abnormal image

- 
  1. Check the quality and length of the video cable.
  2. Check the cable connections.
  3. Check if the Iris under **Exposure settings** is set to 'closed'.

### Dithering or flickering image

- 
  1. Check the camera fixation and nearby vibration sources.
  2. Check the [Anti-flickering](#) setting in the OSD.
  3. Check the [Noise Reduction](#) settings in the OSD.

### Color issues

-  Check the OSD settings for [exposure](#), white balance, color temp, Red and Bluetuning.



When experiencing image problems, you may also check [Appendix D - CMOS Image Sensor Characteristics](#)

## Autofocus Issues



- Check the [autofocus](#) (position, speed etc.) before streaming
- Check [Video/Camera Settings](#) in de WebGUI or the OSD menu (for example: if the image is too bright, too dark, or too noisy, the camera will have difficulties to focus)



Check environmental conditions and the subject of focussing. The camera will have difficulties to focus in the following situations:

- Light: Strong light, low light/dark areas and backlight conditions
- Moving subjects
- Small objects before a plain or solid background
- Blurry or unsharp subjects: filming through wet glass or dirty objects
- Distance: filming two or more different subjects, some near and some far away
- Position in the image: subject positioned in the corners of the picture
- Faces: partly hidden faces, sideways filmed faces, diagonal or up side down
- When the camera itself moves, or when the iris is narrowed down



When you experience one or more of the above mentioned problems check also our [Appendix - CMOS characteristics](#)

## Control

### No self-test (PTZ cameras only) and no power LED



1. Check the net power
2. Check the power supply

### Remote Controller does not work



1. Check the power of the controller.
2. Check the RS-232 or RS-485 cable quality, length, polarity and network architecture.
3. Check the serial communication settings on the camera and controller.
4. Check the VISCA / PELCO address settings on the camera and controller.
5. Check the IP network settings on the camera and controller.

### Camera does not respond to commands send over IP



1. Check if the [Low Power Mode](#) is set to ON. If so disable it.

## WebGUI

### Cannot enter WebGUI



1. Check the network cable.
2. Check if the computer is connected to the same subnet as the camera.
3. Use an **incognito** window in your browser, sometimes cache issues arise when using multiple cameras that have the same default IP address
4. Reset the factory default IP settings by pressing **[\*] [#] [Manual]** and **Reboot**.

### Firmware update failed



1. Check firmware file integrity, download it again.
2. Make sure you are trying to flash the UVC file for the correct color camera (ARM is generic, UVC is color-dependent).



# APPENDIX A - VISCA SETTINGS AND COMMAND LIST

VISCA is a professional camera control protocol used with PTZ cameras. It works by sending commands to the camera either over a serial or over an IP connection, in return the camera sends ACK acknowledgment and COM completion answers to let the sender know the commands have been received and completed. The [list](#) below describes the commands, ranges and camera answers.

The VISCA Settings and Command list is available as an appendix in this manual and as an separate document that you can download on the [product website](#).

## VISCA over Serial Connection

VISCA is based on RS232 Serial communications at 9600 bit/s, 8N1, no flow control. VISCA uses a serial repeater network configuration to communicate between the controller (device #0) and up to 7 peripherals (#1 through #7). The daisy chain cable configuration means that a message walks the chain until it reaches the target device identified in the data packet. Responses then walk the rest of the way down the chain and back up again to reach the sender. Some packets are broadcast to all devices.

A command data packet consists of:

- Address byte (1) message header
- Information bytes (1..14)
- Terminating byte (1) 0xFF



You can use **Hercules SETUP Utility** application and a serial connection to make this work.

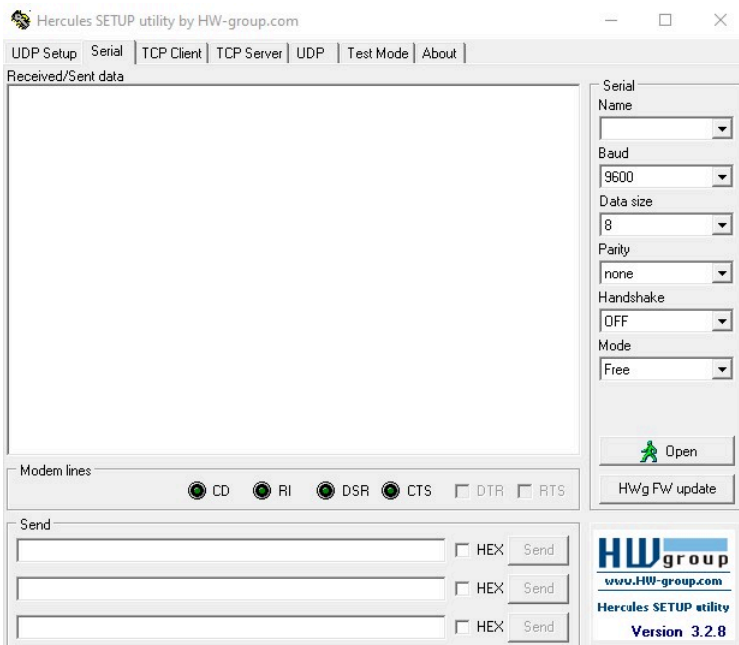

## VISCA over IP

Avonic IP cameras are implemented with a TCP and an UDP server. The TCP as well as the UDP port are by default set to port [1259](#).



The default VISCA address setting is **always 1** when using VISCA over IP. As all cameras are uniquely identified by their IP address, all VISCA addresses are set to 1, the serial addressing plays no part. For VISCA over IP, every command starts with **81 xx xx xx** .



To control the camera, you need an TCP or UDP supported application, like **Hercules SETUP utility** or **Packet Sender** for example. Follow the instructions below:

1. Open the TCP/ UDP supported application.
2. Fill in the camera's IP Address, TCP/UDP port number and connect the application to your camera.  
Once the connection between client and server is set up, the client will be able to send PTZ commands to the server. The server then parses and executes the PTZ command.
3. Fill in the command to be sent to the camera. The camera will send you the return commands.
4. If you see the returned commands (in exception with UDP), the camera has executed the command. You can check this in the WebGUI of the camera.



Default settings:

- TCP port 1259
- UDP port 1259 (same port as TCP; is correct)
- VISCA address 1

The pictures below are showing an example of a VISCA command (Focus near) with their return commands. The green RX commands in the picture "Receive message" is the ACK command (to let the sender know that the command is received and executed) and the COM command (to confirm that the command has been successfully executed and completed). You can find these commands in the [Camera Return Command list](#) and the [Inquiry Command list](#).



Note that the pictures below are ONLY an example to show you how a TCP supported application works. The pictures could be different from the application you are using!

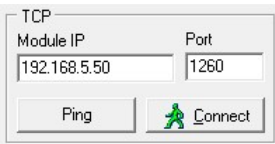

TCP  
 Module IP: 192.168.5.50  
 Port: 1260  
 Ping [button] Connect [button with green person icon]

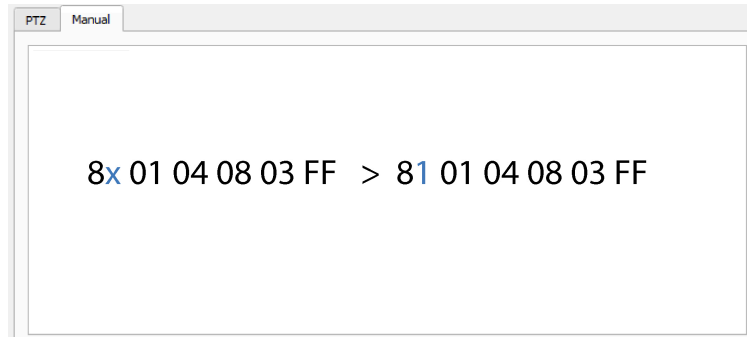

PTZ Manual

8x 01 04 08 03 FF > 81 01 04 08 03 FF

VISCA IP address and port

VISCA command example

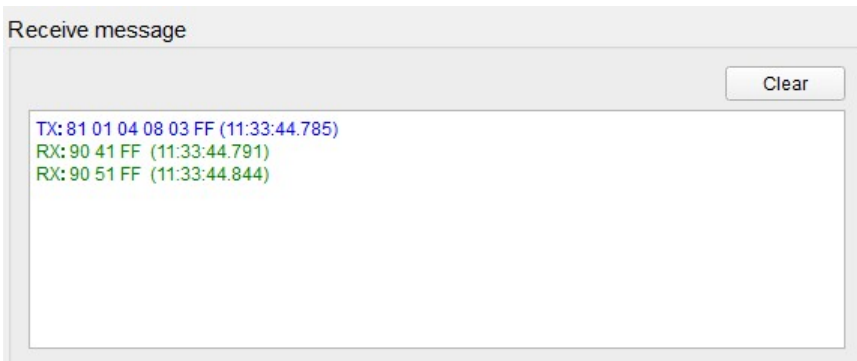

Receive message [Clear button]

TX: 81 01 04 08 03 FF (11:33:44.785)

RX: 90 41 FF (11:33:44.791)

RX: 90 51 FF (11:33:44.844)

## VISCA over IP using the full Sony VISCA protocol

All Avonic cameras are capable of being controlled using the UDP Sony version of VISCA consisting of long VISCA commands, including headers and message counters. The advantage of using this version of VISCA is the fact that the camera responds with the same header **counter** as was used in the command. This makes it possible to match each response to each command sent. This is especially helpful when programming automated camera control systems.



For the following example Hercules SETUP utility is used to recall preset 1 using VISCA. Follow the instructions below:

1. Set the local port and camera port. Both must be set to **52381**. Any other port won't work!

The camera will send its answers back to the port that was used to send the command (port 52381).



Make sure that you have your **sent and receive** window set to display HEX data.

In the example below the camera is switched between:

- Preset 1: VISCA command 81 01 01 3F 02 01 FF and
- Preset 2: VISCA command 81 01 01 3F 02 02 FF



1. Type the command in the **Send** box. The command consists of the **(camera) address**, marked in blue and 7 bytes marked in red. This means that the complete VISCA command looks like this:

- Preset 1: VISCA command 010000070000000181**0101F0201FF**
- Preset 2: VISCA command 010000070000000581**01013F0202FF**

The Visca over IP header consists of the 3rd and 4th bytes of the complete header. They indicate length of the payload (VISCA command). At this point, the value can vary depending on what VISCA command is sent. Using the example of **Preset Recall 1** from above:

- 010000070000000181**01013F0201FF** the 4th byte is '7' meaning the payload of the VISCA command is 7 bytes. Another point in the header is the message counter possibility on the 8th byte, in this instance it's '1'. On the second command where **Preset 2** was recalled, the message counter was set to '5'.



1. Click on **Send**. If you have done this correct, you should get the same as on the picture below:

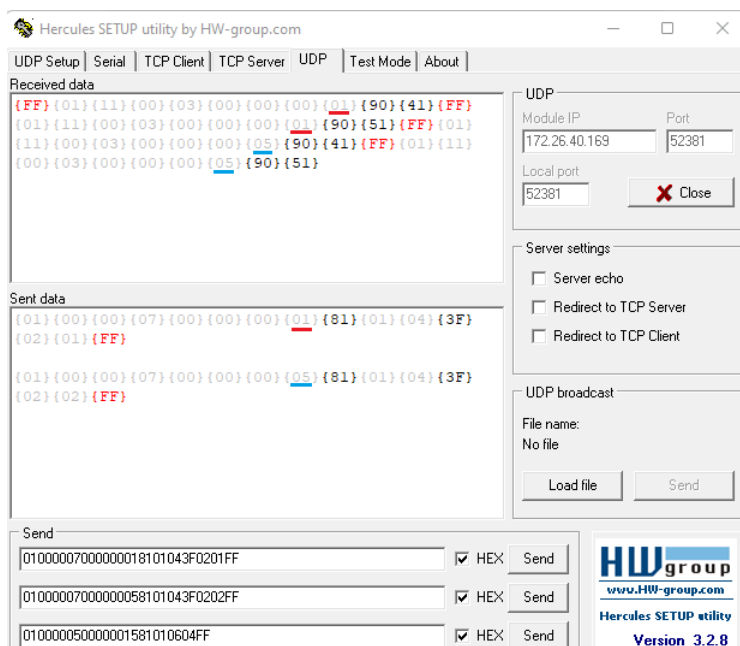

## Camera Return Commands

All parameter values are in HEX.

- x = Camera Address
- y = Socket Number
- z = Camera Address + 8



This is one list for all Avonic PTZ Cameras (CM40 series, CM70 and CM90 series). Some features are CM70 and/or CM90 series specific and will not work in the CM40 series cameras.

Return/complete Command			
Command	Function	Command Packet	Comments
ACK/Completion Messages	ACK	90 4y FF (y: Socket No.)	Return when the command is accepted.
	Completion	90 5y FF (y: Socket No.)	Return when the command has been executed.

Error Command			
Command	Function	Command Packet	Comments
Error Messages	Syntax Error	90 60 02 FF	Returned when the command format is different or when a command with illegal command parameters is accepted.
	Command Buffer Full	90 60 03 FF	Indicates that two sockets are already being used (executing two commands) and the command could not be accepted when received.
	Command Canceled	90 6y 04 FF (y: Socket No.)	Returned when a command which is being executed in a socket specified by the cancel command is canceled. The completion message for the command is not returned.
	No Socket	90 6y 05 FF (y: Socket No.)	Returned when no command is executed in a socket specified by the cancel command, or when an invalid socket number is specified.
	Command Not Executable	90 6y 41 FF (y: Execution command Socket No. Inquiry command: 0)	Returned when a command cannot be executed due to current conditions. For example, when commands controlling the focus manually are received during auto-focus.

## Camera Control Commands

All parameter values are in HEX

- x = Camera Address
- y = Socket Number
- z = Camera Address + 8

Camera Control Commands			
Command	Function	Command Packet	Comments
Address Set	Broadcast	88 30 01 FF	Address setting
CAM_Power	On	8x 01 04 00 02 FF	Power ON
	Off	8x 01 04 00 03 FF	Power OFF
	Reboot	8x 0A 01 06 01 FF	Reboot
CAM_Zoom	Stop	8x 01 04 07 00 FF	
	Tele (Standard speed)	8x 01 04 07 02 FF	
	Wide (Standard speed)	8x 01 04 07 03 FF	
	Tele (Variable speed)	8x 01 04 07 2p FF	p = 0(low speed) -F(high speed)
	Wide (Variable speed)	8x 01 04 07 3p FF	
	Direct	8x 01 04 47 0p 0q 0r 0s FF	pqrs(0-F): Zoom Position
	Zoom Wide ~ Tele	00 00 00 00 ~ 04 00 00 00 (PQRS)	
CAM_Focus	Stop	8x 01 04 08 00 FF	
	Far (Standard speed)	8x 01 04 08 02 FF	
	Near (Standard speed)	8x 01 04 08 03 FF	
	Far (Variable speed)	8x 01 04 08 2p FF	p = 0(low) - F(high)
	Near (Variable speed)	8x 01 04 08 3p FF	
	Direct Focus Position	8x 01 04 48 0p 0q 0r 0s FF	min p = 0, q = 0, r = 0, s = 0 max p = 0, q = 6, r = E, s = A
	Auto Focus	8x 01 04 38 02 FF	AF On
	Manual Focus	8x 01 04 38 03 FF	AF Off
	Auto/Manual	8x 01 04 38 10 FF	AF Toggle On/Off
	OnePush mode	8x 01 04 38 04 FF	
	OnePush trigger	8x 01 04 18 01 FF	
	Focus Near ~ Far	Variable ~ 00 00 00 00 (PQRS)	pqrs: Focus Position
CAM_WB	Auto	8x 01 04 35 00 FF	Normal Auto
	Indoor mode	8x 01 04 35 01 FF	Indoor mode
	Outdoor mode	8x 01 04 35 02 FF	Outdoor mode
	OnePush mode	8x 01 04 35 03 FF	One Push WB mode
	OnePush trigger	8x 01 04 10 05 FF	One Push WB Trigger
	Manual	8x 01 04 35 05 FF	Manual Control mode

Camera Control Commands			
Command	Function	Command Packet	Comments
CAM_Bgain	Reset	8x 01 04 04 00 FF	Manual Control of BGain
	Up	8x 01 04 04 02 FF	
	Down	8x 01 04 04 03 FF	
	Direct	8x 01 04 44 00 00 0p 0q FF	pq: B Gain
CAM_Rgain	Reset	8x 01 04 03 00 FF	Manual Control of RGain
	Up	8x 01 04 03 02 FF	
	Down	8x 01 04 03 03 FF	
	Direct	8x 01 04 43 00 00 0p 0q FF	pq: R Gain
CAM_AE	Full Auto	8x 01 04 39 00 FF	Automatic Exposure mode
	Manual	8x 01 04 39 03 FF	Manual Control mode
	Shutter priority	8x 01 04 39 0A FF	Shutter Priority Automatic Exposure mode
	Iris priority	8x 01 04 39 0B FF	Iris Priority Automatic Exposure mode
	Bright	8x 01 04 39 0D FF	Bright Mode (Manual control)
CAM_Iris	Reset	8x 01 04 0B 00 FF	Iris Setting (CAM_AE is set to Manual)
	Up	8x 01 04 0B 02 FF	
	Down	8x 01 04 0B 03 FF	
	Direct Iris Position	8x 01 04 4B 00 00 0p 0q FF	(Manual and Iris Priority) min p = 0 q = 0 max p = 0, q = C
CAM_Shutter	Direct	8x 01 04 4A 00 00 0p 0q FF	min p = 0 q = 0 max p = 1 q = 0
CAM_Gain	Reset	8x 01 04 0C 00 FF	Gain Setting
	Direct	8x 01 04 0C 00 00 0p 0q FF	pq: Gain Position 0 ~ 20 (0 = 00 HEX) Manual exposure
	Gain Limit	8x 01 04 2C 0p FF	p: Gain Position 0 ~ 15 (0 = 00 HEX) Auto exposure
CAM_Bright (only works with exposure mode Bright enabled)	Reset	8x 01 04 0D 00 FF	Bright Setting
	Up	8x 01 04 0D 02 FF	
	Down	8x 01 04 0D 03 FF	
	Direct	8x 01 04 0D 00 00 0p 0q FF	pq: Bright Position (0 ~ 23 max p = 1 and q = 7)
CAM_ExpComp(EV and EV Level)	On	8x 01 04 3E 02 FF	Exposure Compensation On/Off
	Off	8x 01 04 3E 03 FF	
	Reset	8x 01 04 0E 00 FF	Exposure Compensation Amount Setting
	Up	8x 01 04 0E 02 FF	
	Down	8x 01 04 0E 03 FF	
	Direct	8x 01 04 4E 00 00 0p 0q FF	

Camera Control Commands			
Command	Function	Command Packet	Comments
CAM_BackLight	On	8x01 04 33 02 FF	Back Light Compensation On/Off
	Off	8x01 04 33 03 FF	
CAM_NR(2D)Level (CM40 and CM70 series only)	-	8x01 04 53 0p FF	p: NR Setting (0: Off, level 1 to 7, 8 = AUTO)
CAM_NR(3D)Level	-	8x01 04 54 0p FF	p: NR Setting (0: Off, level 1 to 8)
CAM_Flicker	-	8x01 04 23 0p FF	p: Flicker Settings (0: Off, 1: 50Hz, 2: 60Hz)
CAM_DHotPixel (CM40 and CM70 series only)	-	8x01 04 56 0p FF	p: Dynamic Hot Pixel Setting (0: Off, level 1 to 5)
CAM_Aperture (sharpness)	Reset	8x01 04 02 00 FF	Aperture Control
	Up	8x01 04 02 02 FF	
	Down	8x01 04 02 03 FF	
	Direct	8x01 04 42 00 00 0p 0q FF	
CAM_PictureEffect	Off	8x01 04 63 00 FF	Picture Effect Setting
	B&W	8x01 04 63 04 FF	
CAM_Memory(preset)	Reset	8x01 04 3F 00 pp FF	pp: Memory Number (=0 to 127)
	Set	8x01 04 3F 01 pp FF	
	Recall	8x01 04 3F 02 pp FF	
CAM_LR_Reverse	On	8x01 04 61 02 FF	Image Flip Horizontal On/Off
	Off	8x01 04 61 03 FF	
CAM_PictureFlip	On	8x01 04 66 02 FF	Image Flip Vertical On/Off
	Off	8x01 04 66 03 FF	
Freeze (CM70, CM90 series ONLY)	Freeze ON	8x04 04 62 02 FF	Freeze ON immediately
	Freeze OFF	8x04 04 62 03 FF	Freeze OFF immediately
	Preset Freeze ON	8x04 04 62 22 FF	Freeze ON when running preset
	Preset Freeze OFF	8x04 04 62 23 FF	Freeze OFF when running preset
SYS_Menu	Off	8x01 06 06 03 FF	Turns the OSD menu On/Off
	On	8x01 06 06 02 FF	
CAM_ColorGain	Direct	8x01 04 49 00 00 00 0P FF	p: Color Gain setting 0h (60%) to Eh (200%)

Camera Control Commands			
Command	Function	Command Packet	Comments
Pan_tiltDrive	Up	8x01 06 01 VV WW 03 01 FF	VV: Pan speed 0x01 (low speed) to 0x18 (high speed) WW: Tilt speed 0x01 (low speed) to 0x14 (high speed) YYYY: Pan Position ZZZZ: Tilt Position
	Down	8x01 06 01 VV WW 03 02 FF	
	Left	8x01 06 01 VV WW 01 03 FF	
	Right	8x01 06 01 VV WW 02 03 FF	
	Upleft	8x01 06 01 VV WW 01 01 FF	
	Upright	8x01 06 01 VV WW 02 01 FF	
	DownLeft	8x01 06 01 VV WW 01 02 FF	
	DownRight	8x01 06 01 VV WW 02 02 FF	
	Stop	8x01 06 01 VV WW 03 03 FF	
	AbsolutePosition	8x01 06 02 VV WW 0Y 0Y 0Y 0Y 0Z 0Z 0Z 0Z FF	
	RelativePosition	8x01 06 03 VV WW 0Y 0Y 0Y 0Y 0Z 0Z 0Z 0Z FF	
	Pan range: -170° ~ +170°	0F 06 07 00 ~ 50 00 09 09 (YYYY)	
	Tilt range: -30° ~ +90°	0F 0E 04 05 ~ 00 05 01 00 (ZZZZ)	
	Home	8x01 06 04 FF	
Reset	8x01 06 05 FF		
Pan_tiltLimitSet	LimitSet	8x01 06 07 00 0W 0Y 0Y 0Y 0Y 0Z 0Z 0Z 0Z FF	W: 1 UpRight 0: Down-Left YYYY: Pan Limit Position ZZZZ: Tilt Position
	LimitClear	8x01 06 07 01 0W 07 0F 0F 0F 0F 0F 0F 0F FF	
CAM_AFsensitivity	High	8x01 04 58 01 FF	AF Sensitivity High/Normal/Low
	Normal	8x01 04 58 02 FF	
	Low	8x01 04 58 03 FF	
CAM_SettingReset	Reset	8x01 04 A0 10 FF	Reset Factory Setting
CAM_Brightness	Direct	8x01 04 A1 00 00 0p 0q FF	pq: Brightness Position
CAM_Contrast	Direct	8x01 04 A2 00 00 0p 0q FF	pq: Contrast Position
CAM_Flip	Off	8x01 04 A4 00 FF	Single Command For Video Flip
	Flip-H	8x01 04 A4 01 FF	
	Flip-V	8x01 04 A4 02 FF	
	Flip-HV	8x01 04 A4 03 FF	
CAM_Autoflip	Autoflip ON	8x01 02 70 02 FF	Autoflip ON
	Autoflip OFF	8x01 02 70 03 FF	Autoflip OFF
CAM_SettingSave	Save	8x01 04 A5 10 FF	Save Current Setting
CAM_Iridix	Direct	8x01 04 A7 00 00 0p 0q FF	pq: Iridix Position
CAM_AWBSensitivity	High	8x01 04 A9 00 FF	High
	Normal	8x01 04 A9 01 FF	Normal
	Low	8x01 04 A9 02 FF	Low



Camera Control Commands			
Command	Function	Command Packet	Comments
CAM_AFZone	Front Focus	8x 01 04 AA 00 FF	AF Zone select
	Back Focus	8x 01 04 AA 01 FF	
	Meeting	8x 01 04 AA 02 FF	
	Moving Objects	8x 01 04 AA 03 FF	
	Center Focus	8x 01 04 AA 04 FF	
CAM_ColorHue	Direct	8x 01 04 4F 00 00 00 0p FF	p: Color Hue setting 0h (- 14 degrees) to Eh (+14 degrees)
Pan-tilt_MaxSpeed	High SpeedPan/Tilt ON	8x 0A 01 31 03 FF	High Speed PTON
	High SpeedPan/Tilt OFF	8x 0A 01 31 02 FF	High Speed PTOFF
ARM/MCU_Version	Inquiry ARM/MCU Version	8x 09 0A 01 03 FF	Returned version in HEX, for example: 02 05 00 (version 2.5.0)
CAM/UVC_Version	Inquiry Cam/UVC version	8x 09 00 02 FF	Returned version in HEX, for example: 02 05 09 (version 2.5.9)
CAM_TallyLight (CM70 series only with license active and CM90 series)	Red	8x 01 7E 01 0A 00 02 03 FF	Tally Light RedON
	Green	8x 01 7E 01 0A 00 03 02 FF	Tally Light GreenON
	Off	8x 01 7E 01 0A 00 03 03 FF	Tally Light OFF
Preset_H_Speed	Horizontal (Pan) speed between presets	81 01 03 01 qq FF	qq= speed setting 1 ~ 25 (1 = 00 HEX, 25 = 18 HEX)
Preset_V_Speed	Vertical (Tilt) speed between presets	81 01 03 02 qq FF	qq = speed setting 1 ~ 21 (1 = 00 HEX, 21 = 14 HEX)
Preset_Z_Speed	Zoom speed between presets	81 01 03 03 qq FF	qq = speed setting 1 ~ 8 (1 = 00 HEX, 8 = 07 HEX)
Blue_Tuning (autowhitebalance active)	more or less blue while maintaining auto white balance active	81 0A 01 13 pp FF	pp = setting -10 ~ +10(00~14 HEX)
Red_Tuning (autowhitebalance active)	more or less red while maintaining auto white balance active	81 0A 01 12 pp FF	pp = setting -10 ~ +10(00~14 HEX)

Camera Control Commands				
Command	Function	Command Packet	Comments CM40/ CM70	Comments CM90 (HDMI)
VideoSystem_Set  (CM40 series: It is possible to set the video format, but since the video format is dictated by the computer the camera is connected with, the picture will NOT change to that format.)		8x 01 06 35 00 pp FF	pp: Video Format	
			00: 1080p60	
			01: 1080p50	
			02: 1080i60	
			03: 1080i50	
			04: 720p60	
			05: 720p50	
			06: 1080p30	
			07: 1080p25	
			08: 720p30	08: -
			09: 720p25	09: -
			0A: 1080p59.94	0A: 1080p59
			0B: 1080i59.94	0B: 1080i59
			0C: 720p59.94	0C: 720p59
			0D: 1080p29.97	0D: 1080p29
0E: 720p29.97				

## Inquiry Commands

all parameter values are in hex

- x = camera address
- y = socket number
- z = camera address + 8

Inquiry Commands			
Command	Function	Command Packet	Comments
CAM_ZoomPosInq	8x 09 04 47 FF	90 50 0p 0q 0r 0s FF	pqrs: Zoom Position
CAM_FocusAFModelInq	8x 09 04 38 FF	90 50 02 FF	Auto Focus
		90 50 03 FF	Manual Focus
		90 50 04 FF	OnePush Focus
CAM_FocusPosInq	8x 09 04 48 FF	90 50 0p 0q 0r 0s FF	pqrs: Focus Position
CAM_WBModelInq	8x 09 04 35 FF	90 50 00 FF	Auto
		90 50 01 FF	Indoor mode
		90 50 02 FF	Outdoor mode
		90 50 03 FF	OnePush mode
		90 50 05 FF	Manual
CAM_RGainInq	8x 09 04 43 FF	90 50 00 00 0p 0q FF	pq: R Gain
CAM_BGainInq	8x 09 04 44 FF	90 50 00 00 0p 0q FF	pq: B Gain
CAM_GainInq (CM70/ CM90 series ONLY)	8x 09 04 0C FF	90 50 00 FF	Manual Exposure Direct Gain
CAM_AEModelInq	8x 09 04 39 FF	90 50 00 FF	Full Auto
		90 50 03 FF	Manual
		90 50 0A FF	Shutter priority
		90 50 0B FF	Iris priority
		90 50 0D FF	Bright
CAM_ShutterPosInq	8x 09 04 4A FF	90 50 00 00 0p 0q FF	pq: Shutter Position
CAM_IrisPosInq	8x 09 04 4B FF	90 50 00 00 0p 0q FF	pq: Iris Position
CAM_BrightPosInq	8x 09 04 4D FF	90 50 00 00 0p 0q FF	pq: Bright Position
CAM_ExpComp-ModelInq	8x 09 04 3E FF	90 50 02 FF	On
		90 50 03 FF	Off
CAM_ExpCompPosInq	8x 09 04 4E FF	90 50 00 00 0p 0q FF	pq: ExpComp Position
CAM_Backlight-ModelInq	8x 09 04 33 FF	90 50 02 FF	On
		90 50 03 FF	Off
CAM_Noise2DLevel	8x 09 04 53 FF	90 50 0p FF	Noise Reduction (2D) p: 0 to 7, 8 = AUTO
CAM_Noise3DLevel	8x 09 04 54 FF	90 50 0p FF	Noise Reduction (3D) p: 0 to 8
CAM_FlickerModelInq	8x 09 04 55 FF	90 50 0p FF	p: Flicker Settings(0: OFF, 1: 50Hz, 2: 60Hz)

Inquiry Commands			
Command	Function	Command Packet	Comments
CAM_Aperture-ModelInq (Sharpness)	8x 09 04 05 FF	90 50 02 FF	Auto Sharpness
		90 50 03 FF	Manual Sharpness
CAM_ApertureInq(Sharpness)	8x 09 04 42 FF	90 50 00 00 0p 0q FF	pq: Aperture Gain
CAM_PictureEffectModelInq	8x 09 04 63 FF	90 50 00 FF	Color
		90 50 04 FF	B&W

Inquiry Commands			
Command	Function	Command Packet	Comments
CAM_MemoryInq	8x 09 04 3F FF	90 50 0p FF	p: Memory (Preset) number last operated.
SYS_MenuModelInq	8x 09 06 06 FF	90 50 02 FF	On
		90 50 03 FF	Off
CAM_LR_ReverseInq	8x 09 04 61 FF	90 50 02 FF	On
		90 50 03 FF	Off
CAM_PictureFlipInq	8x 09 04 66 FF	90 50 02 FF	On
		90 50 03 FF	Off
CAM_ColorGainInq	8x 09 04 49 FF	90 50 00 00 00 0p FF	p: Color Gain setting 0h (60%) to Eh (200%)
CAM_BTuningInq	81 09 0A 01 13 FF	90 50 pp FF	pp = setting -10 ~ +10 (00~14 HEX)
CAM_RTuningInq	81 09 0A 01 12 FF	90 50 pp FF	pp = setting -10 ~ +10 (00~14 HEX)
VideoSystemInq  ( <b>CM40 series:</b> It is possible to set the video format, but since the video format is dictated by the computer the camera is connected with, the picture will not change to that format.)	8x 09 06 23 FF	90 50 00 FF	1920x1080p60
		90 50 01 FF	1920x1080p50
		90 50 02 FF	1920x1080i60
		90 50 03 FF	1920x1080i50
		90 50 04 FF	1280x720p60
		90 50 05 FF	1280x720p50
		90 50 06 FF	1920x1080p30
		90 50 07 FF	1920x1080p25
		90 50 08 FF	1280x720p30
		90 50 09 FF	1280x720p25
		90 50 0A FF	1920x1080p59.94
		90 50 0B FF	1920x1080i59.94
		90 50 0C FF	1280x720p59.94
		90 50 0D FF	1920x1080p29.97
90 50 0E FF	1280x720p29.97		
Pan-tiltMaxSpeedInq	8x 09 06 11 FF	90 50 ww zz FF	ww: Pan Max Speed zz: Tilt Max Speed

Inquiry Commands			
Command	Function	Command Packet	Comments
Pan-tiltPosInq	8x 09 06 12 FF	90 50 0w 0w 0w 0w 0z 0z 0z 0z FF	www: Pan Position zzz: Tilt Position
CAM_GainLimitInq	8x 09 04 2C FF	90 50 0q FF	p: Gain Limit
	8x 09 04 2C FF	90 50 07 FF	Auto exposure
CAM_DHotPixelInq	8x 09 04 56 FF	90 50 0q FF	p: Dynamic Hot Pixel Setting (0: Off, level 1 to 6)
CAM_AFSensitivityInq	8x 09 04 58 FF	90 50 01 FF	High
		90 50 02 FF	Normal
		90 50 03 FF	Low
CAM_BrightnessInq	8x 09 04 A1 FF	90 50 00 00 0p 0q FF	pq: Brightness Position
CAM_ContrastInq	8x 09 04 A2 FF	90 50 00 00 0p 0q FF	pq: Contrast Position

Inquiry Commands			
Command	Function	Command Packet	Comments
CAM_FlipInq	8x 09 04 A4 FF	90 50 00 FF	Off
		90 50 01 FF	Flip-H
		90 50 02 FF	Flip-V
		90 50 03 FF	Flip-HV
CAM_IridixInq	8x 09 04 A7 FF	90 50 00 00 0p 0q FF	pq: Iridix Position
CAM_AFZone	8x 09 04 AA FF	90 50 00 FF	Front Focus
		90 50 01 FF	Back Focus
		90 50 02 FF	Meeting
		90 50 03 FF	Moving Objects
		90 50 04 FF	Center Focus
CAM_ColorHueInq	8x 09 04 4F FF	90 50 00 00 00 0p FF	p: Color Hue setting 0h (-14 degrees) to Eh (+14 degrees)
CAM_AWBSensitivityInq	81 09 04 A9 FF	90 50 00 FF	High
		90 50 01 FF	Normal
		90 50 02 FF	Low
CAM_ZoomPosInq	8x 09 04 47 FF	90 50 0p 0q 0r 0s FF	pqrs: Zoom Position
CAM_FocusAFModelInq	8x 09 04 38 FF	90 50 02 FF	Auto Focus
		90 50 03 FF	Manual Focus
CAM_FocusPosInq	8x 09 04 48 FF	90 50 0p 0q 0r 0s FF	pqrs: Focus Position

Inquiry Commands			
Command	Function	Command Packet	Comments
CAM_WBModelInq	8x 09 04 35 FF	90 50 00 FF	Auto
		90 50 01 FF	Indoor mode
		90 50 02 FF	Outdoor mode
		90 50 03 FF	OnePush mode
		90 50 05 FF	Manual
CAM_RGainInq	8x 09 04 43 FF	90 50 00 00 0p 0q FF	pq: R Gain
CAM_BGainInq	8x 09 04 44 FF	90 50 00 00 0p 0q FF	pq: B Gain
CAM_AEModelInq	8x 09 04 39 FF	90 50 00 FF	Full Auto
		90 50 03 FF	Manual
		90 50 0A FF	Shutter priority
		90 50 0B FF	Iris priority
		90 50 0D FF	Bright
CAM_ShutterPosInq	8x 09 04 4A FF	90 50 00 00 0p 0q FF	pq: Shutter Position
CAM_IrisPosInq	8x 09 04 4B FF	90 50 00 00 0p 0q FF	pq: Iris Position
CAM_BrightPosInq	8x 09 04 4D FF	90 50 00 00 0p 0q FF	pq: Bright Position
CAM_PowerInq	8x 09 04 00 FF	y0 50 02 FF	On
		y0 50 03 FF Off	Off (Standby)

## APPENDIX B - DIMENSIONS

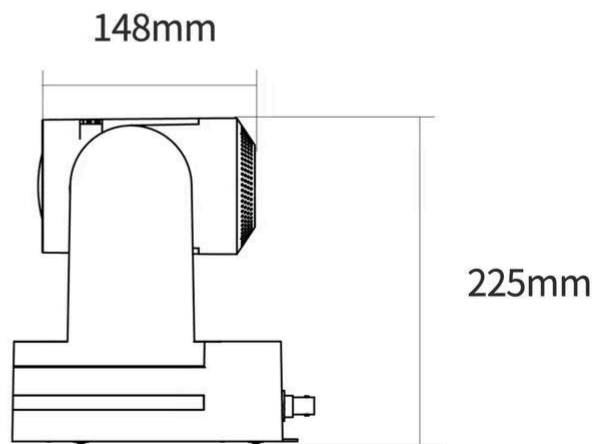
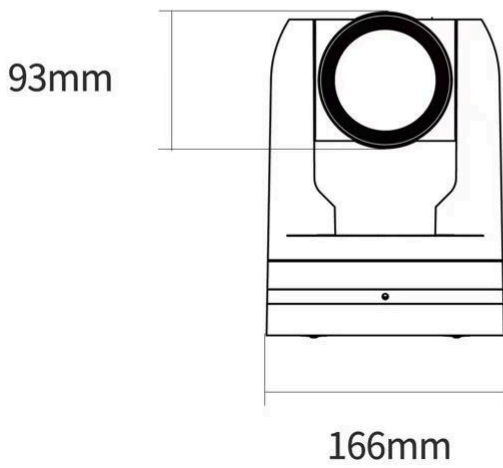
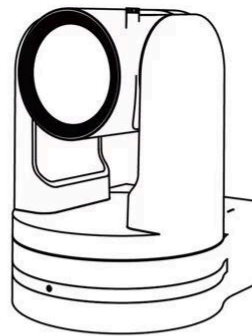
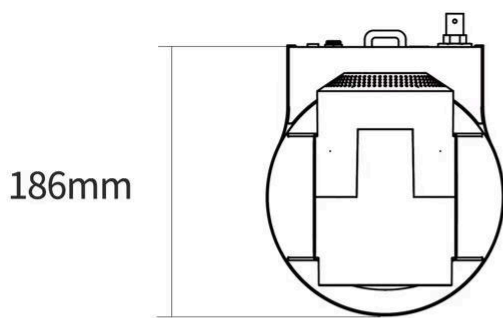

# APPENDIX C - HTTP API

With the HTTP API you can control the camera by using a web browser like Microsoft Edge or Google Chrome for example. It is possible to change multiple settings at once using this feature. This document is available as an Appendix in the CM70/ CM90 series manual and as a separate document that can be downloaded on the [product website](#).

## How to use HTTP API

To use the HTTP API you need the following link:

<http://192.168.5.126/ajaxcom?szCmd=>



Follow instructions below:

1. Click on the link above, or copy and paste it to your browser.
2. Note that the IP Address in this link is an **example of an IP address**. Change this IP Address to the one you use for your camera. See [Network > Ethernet > IP Address](#).
3. Copy the code from the list. Remember that some codes are documented over **multiple lines** and that you need to **copy this from the first to the last bracket!** See the example below:

Function	Code	Command	Setting
Enable	<code>{"SetEnv":{"StreamPublish":{"stMaster":{"wHostPort":1935,"bEnable":1,"nProtoType":3,"nChannel":0}}}}</code>	bEnable	0: off 1: on
Protol Type		nProtoType	2: srt 3: rtmp
Host Address	<code>{"SetEnv":{"StreamPublish":{"stMaster":{"wHostPort":1935,"nProtoType":3,"szHostUrl":"192.168.5.12"},"nChannel":0}}}}</code>	szHostUrl	user-defined
Host Port	<code>{"SetEnv":{"StreamPublish":{"stMaster":{"wHostPort":19355,"nProtoType":3,"nChannel":0}}}}</code>	wHostPort	[0,65535]
Stream Name	<code>{"SetEnv":{"StreamPublish":{"stMaster":{"wHostPort":19355,"nProtoType":3,"szStreamName":"live/1213"},"nChannel":0}}}}</code>	szStreamName	user-defined
User Name	<code>{"SetEnv":{"StreamPublish":{"stMaster":{"wHostPort":19355,"nProtoType":3,"szUserName":"admin"},"nChannel":0}}}}</code>	szUserName	user-defined
Password	<code>{"SetEnv":{"StreamPublish":{"stMaster":{"wHostPort":19355,"nProtoType":3,"szPassword":"123456789"},"nChannel":0}}}}</code>	szPassword	user-defined
SrtKey (SRT Effectie)	<code>{"SetEnv":{"StreamPublish":{"stMaster":{"wHostPort":19355,"nProtoType":3,"szSrtKey":"0123456789"},"nChannel":0}}}}</code>	wSrtKey	user-defined
SrtKeyLen (SRTEffectie)	<code>{"SetEnv":{"StreamPublish":{"stMaster":{"wHostPort":19355,"nProtoType":3,"wSrtKeyLen":10},"nChannel":0}}}}</code>	wSrtKeyLen	[0-32]

4. Paste the code at the end of HTTP link. It will look like this:

[192.163.5.126/ajaxcom?szCmd={\"SysCtrl\":{\"PtzCtrl\":{\"nChannel\":0,\"szPtzCmd\":\"left\\_start\",\"byValue\":50}}}}](http://192.163.5.126/ajaxcom?szCmd={\)

5. Change the settings in the link. In this case:

[192.163.5.126/ajaxcom?szCmd={\"SysCtrl\":{\"PtzCtrl\":{\"nChannel\":0,\"szPtzCmd\":\"left\\_start\",\"byValue\":50}}}}](http://192.163.5.126/ajaxcom?szCmd={\)

6. Press **ENTER**. If **correct**, you get in return:

[192.163.5.126/ajaxcom?szCmd={\"SysCtrl\":{\"PtzCtrl\":{\"nChannel\":0,\"szPtzCmd\":\"left\\_start\",\"byValue\":50}}}}](http://192.163.5.126/ajaxcom?szCmd={\)  
`{\"nRetVal\":0, \"szError\":\"\"}`

If **failed**, you get in return.

[192.163.5.126/ajaxcom?szCmd={\"SysCtrl\":{\"PtzCtrl\":{\"nChannel\":0,\"szPtzCmd\":\"left\\_start\",\"byValue\":50}}}}](http://192.163.5.126/ajaxcom?szCmd={\)  
`{\"nRetVal\":-1879048185, \"szError\":\"\"}`



7. In case of a failed return, check the following:
  - Brackets in the code. Have you copy and paste the first and the last bracket?
  - Syntax errors in the code/ correct numbers in the key values. Some camera settings are having a specific range. The SRT key for example has a range of 0 - 32. If you have typed 33 it would exceed the range of this key.
  - No long white spaces between the key values of the code. For example this " code " is error and this "code" is right.
  - If you have typed the correct IP address of the camera.
8. If you have done it correct, you can check the settings you have changed in the WebGUI of the camera.

## Curl

It is also possible to change the camera settings at once by using the **Command Prompt** from Windows.



Follow instructions below:

1. Click on **Start** in the left corner of your screen in Windows.
2. Type **Notepad** and open this application.
3. Copy and paste the following http link: <http://192.168.5.126/ajaxcom> and the **code** in the [HTTP API code list](#) in **Notepad**.
4. Type **curl**, change the default IP address in the IP Address of your camera, and surround it by quotation marks.
5. Add **--data-raw** between the http link and the code.
6. Type **szCmd** and surround it by quotation marks.
7. **Double** the quotation marks between the brackets! See the example below.

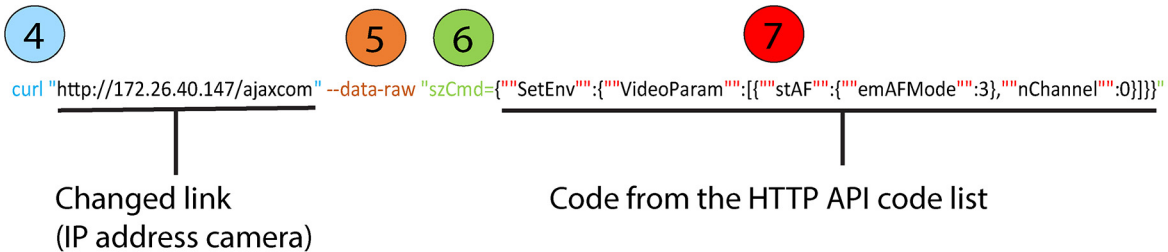

8. Modify the parameters in the code. In the example above **EmAFmode:3** and **nChannel:0** See the [HTTP API code list](#).
9. Click on **Start** in Windows again, type **CMD** and press **Enter**.
10. Copy and paste the link/ code from notepad in **Command Prompt** and press **Enter**.
11. If correct it returns: `{'nRetVal':0, 'szError':''}`

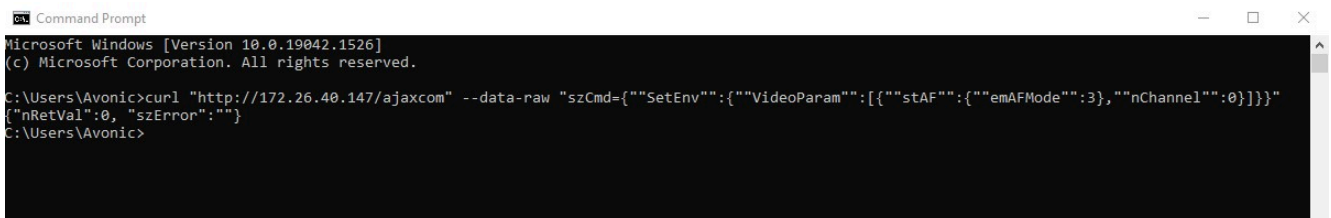

```

Microsoft Windows [Version 10.0.19042.1526]
(c) Microsoft Corporation. All rights reserved.

C:\Users\Avonic>curl "http://172.26.40.147/ajaxcom" --data-raw "szCmd={"SetEnv":{"VideoParam":{"stAF":{"emAFMode":3,"nChannel":0}}}}
{"nRetVal":0, "szError":""}
C:\Users\Avonic>
  
```

## {'GetEnv'}

You can also use the HTTP API to **display the current settings** of the camera in your browser or in the **Command Prompt** application. To do this, you need the {'GetEnv'} codes from the HTTP API code list. If correct you get the following result:



```

{
  "nRetVal": 0,
  "stValue": [
    {
      "stSlave": {
        "wHostPort": 1935,
        "szHostUrl": "172.40.26.147",
        "nProtolType": 2,
        "szStreamName": "live/av1",
        "bEnable": 0,
        "nAbProtolMask": 1,
        "szSrtKey": "",
        "wSrtKeyLen": 0,
        "szUserName": "",
        "szPassword": ""
      },
      "stMaster": {
        "wHostPort": 1935,
        "szHostUrl": "172.40.26.147",
        "nProtolType": 3,
        "szStreamName": "live/av0",
        "bEnable": 0,
        "nAbProtolMask": 1,
        "szSrtKey": "1111111111",
        "wSrtKeyLen": 0,
        "szUserName": "",
        "szPassword": ""
      },
      "nChannel": 0
    }
  ]
}

```

## Web browser

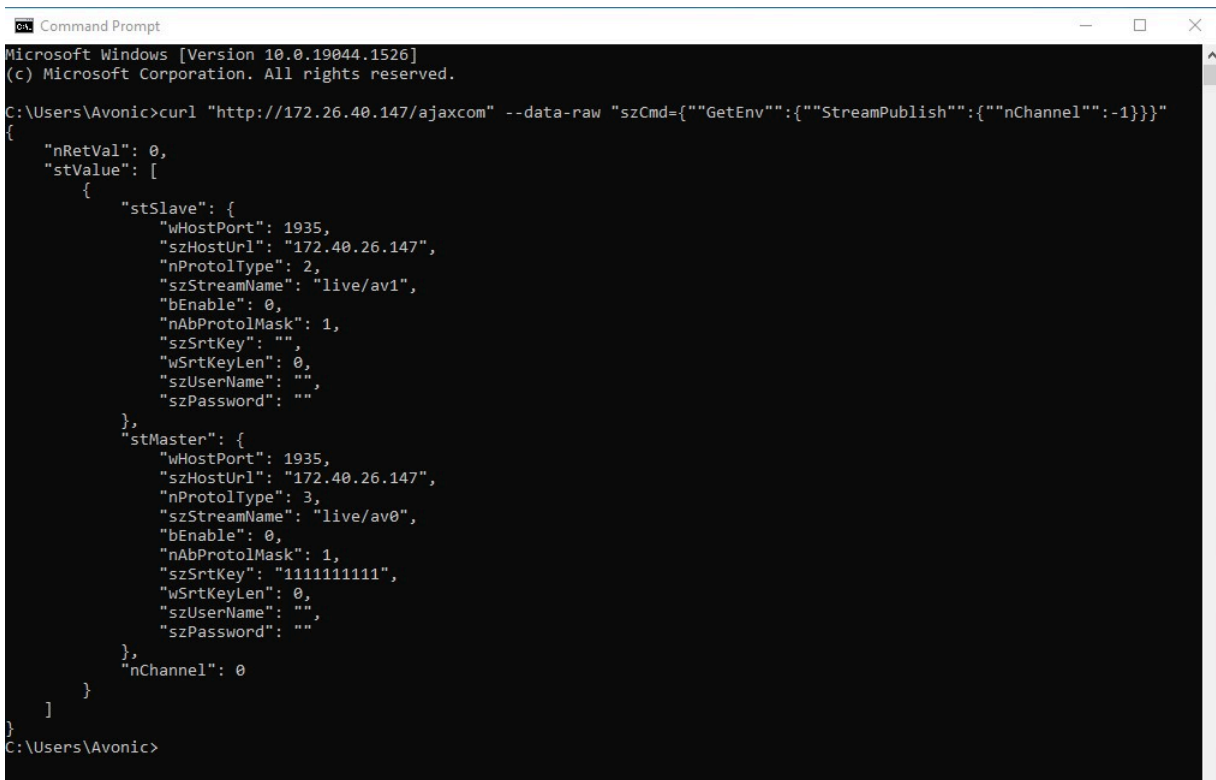

```

C:\Users\Avonic>curl "http://172.26.40.147/ajaxcom" --data-raw "szCmd={'"GetEnv"'":{"StreamPublish":{"nChannel":-1}}}"
{
  "nRetVal": 0,
  "stValue": [
    {
      "stSlave": {
        "wHostPort": 1935,
        "szHostUrl": "172.40.26.147",
        "nProtolType": 2,
        "szStreamName": "live/av1",
        "bEnable": 0,
        "nAbProtolMask": 1,
        "szSrtKey": "",
        "wSrtKeyLen": 0,
        "szUserName": "",
        "szPassword": ""
      },
      "stMaster": {
        "wHostPort": 1935,
        "szHostUrl": "172.40.26.147",
        "nProtolType": 3,
        "szStreamName": "live/av0",
        "bEnable": 0,
        "nAbProtolMask": 1,
        "szSrtKey": "1111111111",
        "wSrtKeyLen": 0,
        "szUserName": "",
        "szPassword": ""
      },
      "nChannel": 0
    }
  ]
}
C:\Users\Avonic>

```

## Command Prompt

## HTTP API code list

### IR Remote Control

IR Enable/Disable			
Command	Code	Command	Setting
szCmd	{"SetEnv":{"ArmPtz": {"blrCtrlEnable":0}}}	blrCtrlEnable	0: ON
			1: OFF

### PTZ

PTZControl			
Code: <a href="http://192.168.5.126/ajaxcom?szCmd={" sysctrl":{"ptzctrl":{"nchanel":0,"szptzcmd":"left_start","byvalue":50}}"="">http://192.168.5.126/ajaxcom?szCmd={"SysCtrl":{"PtzCtrl":{"nChanel":0,"szPtzCmd":"left_start","byValue":50}}}</a>			
Command	Setting	Function	Command
nChanel	0		
byValue	0,100 used to control the speed of ptz		
szPtzCmd			
		left start	left_start
		left stop	left_stop
		leftup start	leftup_start
		leftup stop	leftup_stop
		leftdown start	leftdown_start
		leftdown stop	leftdown_stop
		rightstart	right_start
		rightstop	right_stop
		rightup start	rightup_start
		rightdown start	rightdown_start
		rightdown stop	rightdown_stop
		upstart	up_start
		upstop	up_stop
		downstart	down_start
		downstop	down_stop

### PTZ speed

Set PTZ Speed			
Command	Code	Command	Setting
szCmd	{"SetEnv":{"PTZSpeed": {"nPTZSpeed":1}}}	nPTZSpeed	0: Slow
			1: High

## Speed by Zoom

Set Speed By Zoom			
Command	Code	Command	Setting
szCmd	{'SetEnv':{'ArmPtz':{'bSpeedByZoom':0}}}	bSpeedByZoom	1: on 0: off

## Image Freezing

Set Image Freezing			
Command	Code	Command	Setting
szCmd	{'SetEnv':{'ArmPtz':{'bImageFreezing':0}}}	bImageFreezing	1: on 0: off

## Low power mode

Set Low Power Mode			
Command	Code	Command	Setting
szCmd	{'SetEnv':{'ArmPtz':{'emLowPowerMode':0}}}	emLowPowerMode	2: on 3: off

## Zoom Speed

Set Zoom Speed			
Command	Code	Command	Setting
szCmd	{'SetEnv':{'ArmPtz':{'nZoomSpeed':0}}}	nZoomSpeed	0 - 8

## Preset Pan Speed

Set Preset Pan Speed			
Command	Code	Command	Setting
szCmd	{'SetEnv':{'ArmPtz':{'nPresetPanSpeed':0}}}	nPresetPanSpeed	0 - 25

## Preset Tilt Speed

Set Preset Tilt Speed			
Command	Code	Command	Setting
szCmd	{'SetEnv':{'ArmPtz':{'nPresetTiltSpeed':0}}}	nPresetTiltSpeed	0 - 21

## Preset Zoom Speed

Set Preset Zoom Speed			
Command	Code	Command	Setting
szCmd	{'SetEnv':{'ArmPtz':{'nPresetZoomSpeed':0}}}	nPresetZoomSpeed	0 - 8

## Focus Mode

Focus Mode Commands	
Focus Mode	
Code	Setting
Code	{'SetEnv':{'VideoParam':{'stAF': {'emAFMode':3}, 'nChannel':0}}}
Command	Setting
nChanel	0

Focus Mode Commands			
emAFMode	2: Auto		
	3: Manual		
	4 OnePush		
Zoom and focus			
Code	{"SysCtrl":{"PtzCtrl":{"nChanel":0,"szPtzCmd":"zoomdec_start","byValue":0}}}		
Command	Setting	Function	Command
nChanel	0		
byValue	0		
szPtzCmd			
		Zoom add start	zoomadd_start
		Zoom add stop	zoomadd_stop
		Zoom decrease stop	zoomdec_start
		Zoom decrease stop	zoomdec_stop
		Focus add start	focusadd_start
		Focus add stop	focusadd_stop
		Focus decrease start	focusdec_start
		Focus decrease stop	focusdec_stop

## Preset

Preset Commands			
Code	{"SysCtrl":{"PtzCtrl":{"nChanel":0,"szPtzCmd":"preset_set","byValue":0}}}		
Command	Setting	Function	Command
nChanel	0s		
ByValue	0, 254		
szPtzCmd			
		Set preset	preset_set
		Call preset	preset_call
		Clean preset	preset_clean

## Audio

Audio Configure			
Get audio configure			
Code	{"GetEnv":{"Audio":{}}}		
Set audio configure			
Code	{"SetEnv":{"Audio":{"nSampleBits":16,"nAudioSmstMask": [33554888,33554888,33554433],"bEnable":0,"nInpVolume":4,"nBitRate":64,"nAEncType":7,"byAudioCodeList": [6,7,2],"nSampleRate":44100,"nAudioDelay":0,"nChannel":1}}}		
Function	Code	Command	Setting
Enable	{"SetEnv":{"Audio":{"bEnable":1}}}	bEnable	0: off 1: on

Audio Configure			
Encode Type	{'SetEnv':{'Audio':{'nEncType':7}}}	nEncType	6: Mp3AAC 7: G.711A 2:
Sample Rate	{'SetEnv':{'Audio':{'nSampleRate':32000}}}	nSampleRate (Only supporting these sample rates and g711a can only be 8000.)	16000 32000 44100 48000
Sample Bits	{'SetEnv':{'Audio':{'nSampleBits':16}}}	nSampleBits	16
Bit Rate	{'SetEnv':{'Audio':{'nBitRate':96}}}	nBitRate	32 48 64 96 128
Channel	{'SetEnv':{'Audio':{'nChannel':2}}}	nChannel	1: Mono 2: Stereo
Input Volume	{'SetEnv':{'Audio':{'nInpVolume':5}}}	nInpVolume (range 1 to 10)	Exp:[1, 10]
Audio Delay	{'SetEnv':{'Audio':{'nAudioDelay':0}}}	nAudioDelay	[0, 200]

## Video

### Video encoder

Video Encode	
<b>Get video encode parameters</b>	
Code	{'GetEnv':{'VideoEncode':{'nChannel':-1}}}
<b>Set video encode parameters</b>	
Code	{'SetEnv':{'VideoEncode':[{ <b>stSlave</b> :{'bylFrameMinQP':20,'bylImageQuality':1,'szStreamName':'live/av1','dwVideoCodecMask':160,'emBitRateCtrl':0,'bylImageSizeList':[26,7,9,27,4,5],'dwMaxBitRate':40960,'nFrameRate':25,'nMaxFrameRate':30,'emVideoCodec':5,'nlFrameInterval':75,'emlImageSize':27,'nBitRate':512,'byProfile':2}, <b>stMaster</b> :{'bylFrameMinQP':20,'bylImageQuality':0,'szStreamName':'live/av0','dwVideoCodecMask':160,'emBitRateCtrl':0,'bylImageSizeList':[5,4,9],'dwMaxBitRate':40960,'nFrameRate':25,'nMaxFrameRate':60,'emVideoCodec':5,'nlFrameInterval':75,'emlImageSize':5,'nBitRate':4096,'byProfile':2,'nChannel':0}]}}

### Video encode settings

Video Encode Settings			
Function	Code	Command	Setting
Compressed Format	{'SetEnv':{'VideoEncode':[{ <b>stMaster</b> :{'emVideoCodec':5,'nChannel':0}]}}	emVideoCodec	5: H.264 7: H.265 (BP profile only)
Profile	{'SetEnv':{'VideoEncode':[{ <b>stMaster</b> :{'byProfile':0,'nChannel':0}]}}	byProfile	0: BP 1: MP 2: HP
	{'GetEnv':{'VideoEncode': {'nChannel':-1}}} and receive its returning value. Compared to webpage and this, you can know the different value meaning different image size.	bylImageSizeList (Lists all imagesize, different products have different image size)	

Video Encode Settings			
Image Size	<code>{"SetEnv":{"VideoEncode":{"stMaster":{"emImageSize":4,"nChannel":0}}}}</code>	emImageSize	5: 1920*1080 4: 1280*720 9: 640*480 27: 320*180 26: 640*360
Rate Control	<code>{"SetEnv":{"VideoEncode":{"stMaster":{"emBitRateCtrl":1,"nChannel":0}}}}</code>	emBitRateCtrl	0: CBR 1: VBR

Video Encode Settings			
Function	Code	Command	Setting
Image Quality	<code>{"SetEnv":{"VideoEncode":{"stMaster":{"byImageQuality":5,"nChannel":0}}}}</code>	byImageQuality	0: worst quality 1: between 2: between 3: between 4: between 5: Best quality
Bit Rate (kb/s)	<code>{"SetEnv":{"VideoEncode":{"stMaster":{"dwMaxBitRate":200,"nChannel":0}}}}</code>	dwMaxBitRate	[64, 40960]
Frame Rate (F/S)	<code>{"SetEnv":{"VideoEncode":{"stMaster":{"nFrameRate":25,"nChannel":0}}}}</code>	nFrameRate	[5, 60]
Frame Interval	<code>{"SetEnv":{"VideoEncode":{"stMaster":{"nFrameInterval":70,"nChannel":0}}}}</code>	nFrameInterval	[1, 300]
Frame Min QP	<code>{"SetEnv":{"VideoEncode":{"stMaster":{"byFrameMinQP":70,"nChannel":0}}}}</code>	byFrameMinQP	[10, 51]
Stream Name	<code>{"SetEnv":{"VideoEncode":{"stMaster":{"szStreamName":"live/av01","nChannel":0}}}}</code>	szStreamName	user-defined

## Video Streaming

Stream Publish			
<b>Get stream publish parameters</b>			
Code	<code>{"GetEnv":{"StreamPublish":{"nChannel":-1}}}}</code>		
<b>Set stream publish parameters</b>			
Code	<code>{"SetEnv":{"StreamPublish":{"stSlave":{"wHostPort":1935,"szHostUrl":"192.168.5.11","nProtoType":2,"szStreamName":"live/av1","bEnable":0,"nAbProtolMask":1,"szSrtKey":"","wSrtKeyLen":0,"szUserName":"","szPassword":"","stMaster":{"wHostPort":1935,"szHostUrl":"192.168.5.11","nProtoType":3,"szStreamName":"live/av0","bEnable":0,"nAbProtolMask":1,"szSrtKey":"1111111111","wSrtKeyLen":0,"szUserName":"","szPassword":"","nChannel":0}}}}</code>		
<b>NOTE: When modifying one param, you should take along wHostPort. Otherwise, the host port will be zero.</b>			
Function	Code	Command	Setting
Enable	<code>{"SetEnv":{"StreamPublish":{"stMaster":{"wHostPort":1935,"bEnable":1,"nProtoType":3,"nChannel":0}}}}</code>	bEnable	0: off 1: on
Protol Type		nProtoType	2: srt 3: rtmp

Stream Publish			
Host Address	{'SetEnv':{'StreamPublish':{'stMaster':{'wHostPort':1935,'nProtoType':3,'szHostUrl':"192.168.5.12",'nChannel':0}}}}	szHostUrl	user-defined
Host Port	{'SetEnv':{'StreamPublish':{'stMaster':{'wHostPort':1935,'nProtoType':3,'nChannel':0}}}}	wHostPort	[0,65535]
Stream Name	{'SetEnv':{'StreamPublish':{'stMaster':{'wHostPort':1935,'nProtoType':3,'szStreamName':"live/1213",'nChannel':0}}}}	szStreamName	user-defined
User Name	{'SetEnv':{'StreamPublish':{'stMaster':{'wHostPort':1935,'nProtoType':3,'szUserName':"123",'nChannel':0}}}}	szUserName	user-defined
Password	{'SetEnv':{'StreamPublish':{'stMaster':{'wHostPort':1935,'nProtoType':3,'szPassword':"123",'nChannel':0}}}}	szPassword	user-defined
SrtKey (SRT Effectie)	{'SetEnv':{'StreamPublish':{'stMaster':{'wHostPort':1935,'nProtoType':3,'szSrtKey':"0123456789",'nChannel':0}}}}	szSrtKey	user-defined
SrtKeyLen (SRTEffectie)	{'SetEnv':{'StreamPublish':{'stMaster':{'wHostPort':1935,'nProtoType':3,'wSrtKeyLen':"0",'nChannel':0}}}}	wSrtKeyLen	[0-32]

## (RTP) Multicast Streaming

RTP Multicast	
<b>Get rtp multicast parameters</b>	
Code	{'GetEnv':{'StreamRTPMulticast':{'nChannel':-1}}}
<b>Set rtp multicast parameters</b>	
Code	{'SetEnv':{'StreamRTPMulticast':{'stSlave':{'nProtoType':0,'bEnable':0,'wMultiCastPort':4002,'szMultiCastUrl':"224.1.2.3"},'stMaster':{'nProtoType':1,'bEnable':0,'wMultiCastPort':4000,'szMultiCastUrl':"224.1.2.3"},'nChannel':0}}}}
<b>NOTE: When modifying one param you should take along bEnable and awMultiCastPort. Otherwise, it will be set to 0. Suggesting that when setting env, you can distinguish the stMaster and stSlave.</b>	

## RTP Multicast Settings

RTP Multicast Settings			
Function	Code	Command	Setting
Enable	{'SetEnv':{'StreamRTPMulticast':{'stMaster':{'bEnable':1,'wMultiCastPort':4004,'nChannel':0}}}}	bEnable	0: off 1: on
Protol Type	{'SetEnv':{'StreamRTPMulticast':{'stMaster':{'bEnable':1,'nProtoType':1,'wMultiCastPort':4004,'nChannel':0}}}}	nProtoType	0: RTP 1: TS
Multicast Address	{'SetEnv':{'StreamRTPMulticast':{'stMaster':{'bEnable':0,'szMultiCastUrl':"224.1.2.23",'wMultiCastPort':4004,'nChannel':0}}}}	SzMultiCastUrl	224.0.0.0~ 255.255.255.0
Multicast Port	{'SetEnv':{'StreamRTPMulticast':{'stMaster':{'bEnable':1,'wMultiCastPort':4004,'nChannel':0}}}}	wMultiCastPort	Even [0, 65535]

## Camera Settings

Video Parameters	
<b>Get video parameters</b>	
Code	{'GetEnv':{'VideoParam':{'nChannel':-1}}}
<b>Set video parameters</b>	



Video Parameters			
Focus			
Function	Code	Command	Setting
Focus Mode	{'SetEnv': {'VideoParam':[{ 'stAF': {'emAFMode':2,'nChannel':0}]}]}	emAFMode	2: Auto 3: Manual 4: OnePush
AF-Zone	{'SetEnv': {'VideoParam':[{ 'stAF': {'emAFZone':1,'nChannel':0}]}]}	emAFZone	0: Front Focus 1: Back Focus 2: Meeting 3: Education Tracking 4: Moving Objects 5: Center Focus
AF-Sensitivity	{'SetEnv': {'VideoParam':[{ 'stAF': {'nSensitivity':1,'nChannel':0}]}]}	nSensitivity	1: High 2: Middle 3: Low

## Exposure

Camera Settings				
Exposure				
Mode	{'SetEnv':{'VideoParam':[{ 'stExp': {'emExpMode':0}, 'nChannel':0}]}]}	emExpMode	0: 3: 10: 11: 13:	Auto Manual SAE AAE Bright
Exposure: Auto				
EV	{'SetEnv':{'VideoParam':[{ 'stExp': {'expcomp_mode':2,'nChannel':0}]}]}	expcomp_mode	2: 3:	ON OFF
EV Level	{'SetEnv':{'VideoParam':[{ 'stExp': {'expcomp':7,'nChannel':0}]}]}	expcomp	[0, 14] (7 = default)	
BLC	{'SetEnv':{'VideoParam':[{ 'stExp': {'backlight':2,'nChannel':0}]}]}	backlight	2: 3:	ON OFF

Camera Settings				
Exposure: Auto				
Function	Code	Command	Setting	
Flicker	{'SetEnv':{'VideoParam':[{ 'stExp': {'antiflicker':0,'nChannel':0}]}]}	antiflicker	0: 1: 2:	OFF 50HZ 60HZ
G.Limit	{'SetEnv':{'VideoParam':[{ 'stExp': {'gainLimit':5,'nChannel':0}]}]}	gainLimit	[0, 15]	
DRC	{'SetEnv':{'VideoParam':[{ 'stExp': {'drc':6,'nChannel':0}]}]}	drc	[0, 8]	

Camera Settings				
Exposure: Manual				
shutter	{'SetEnv':{'VideoParam':{'stExp':{'stShutter':{'nShutter':16},'nChannel':0}}}}	nShutter	[0, 33]	
Iris	{'SetEnv':{'VideoParam':{'stExp':{'stIris':{'nIris':12},'nChannel':0}}}}	nIris	[0, 12]	
DRC	{'SetEnv':{'VideoParam':{'stExp':{'drc':8},'nChannel':0}}}}	drc	[0, 8]	
Exposure: SAE				
shutter	{'SetEnv':{'VideoParam':{'stExp':{'stShutter':{'nShutter':16},'nChannel':0}}}}	nShutter	[0, 33]	
DRC	{'SetEnv':{'VideoParam':{'stExp':{'drc':7},'nChannel':0}}}}	drc	[0, 8]	

Camera Settings				
Exposure: AAE				
Flicker	{'SetEnv':{'VideoParam':{'stExp':{'antiflicker':0},'nChannel':0}}}}	Antiflicker	0:	OFF
			1:	50HZ
			2:	60HZ
G.Limit	{'SetEnv':{'VideoParam':{'stExp':{'gainLimit':5},'nChannel':0}}}}	gainLimit	[0, 15]	
Iris	{'SetEnv':{'VideoParam':{'stExp':{'stIris':{'nIris':12},'nChannel':0}}}}	nIris	[0, 12]	
DRC	{'SetEnv':{'VideoParam':{'stExp':{'drc':6},'nChannel':0}}}}	drc	[0, 8]	
Exposure: Bright				
Bright	{'SetEnv':{'VideoParam':{'stExp':{'bright':0},'nChannel':0}}}}	bright	[0, 23]	
Flicker, G.Limit, DRC	You can find the same configure at AAE			

## Color and Image

Camera Settings						
Color						
Function	Code	Command	Setting			
WB Mode	{'SetEnv':{'VideoParam': {'stColor':{'stWbMode': {'emWbMode':0},'nChannel':0}}}}	emWbMode	0: Auto	34: 4900K		
			12: 2400K	4: 5000K		
			13: 2500K	35: 5100K		
			14: 2600K	36: 5200K		
			15: 2700K	37: 5300K		
			16: 2800K	38: 5400K		
			17: 2900K	9: 5500K		
			1: 3000K	39: 5600K		
			18: 3100K	40: 5700K		
			19: 3200K	41: 5800K		
			20: 3300K	42: 5900K		
			21: 3400K	10: 6000K		
			7: 3500K	43: 6100K		
			22: 3600K	44: 6200K		
			23: 3700K	45: 6300K		
			24: 3800K	46: 6400K		
			25: 3900K	6: 6500K		
			2: 4000K	47: 6600K		
			26: 4100K	48: 6700K		
			27: 4200K	49: 6800K		
			28: 4300K	50: 6900K		
			29: 4400K	11: 7000K		
			8: 4500K	51: 7100K		
			30: 4600K	5: Manual		
			31: 4700K	3: OnePush		
			33: 4800K	32: VAR		
RG Tuning	{'SetEnv':{'VideoParam':{'stColor': {'rgaintuning':0},'nChannel':0}}}}	rgaintuning	[0, 20]			
BG Tuning	{'SetEnv':{'VideoParam':{'stColor': {'bgaintuning':20},'nChannel':0}}}}	bgaintuning	[0, 20]			
RG (color manual)	{'SetEnv':{'VideoParam':{'stColor': {'rg':56},'nChannel':0}}}}	rg	[0, 255]			
BG (color manual)	{'SetEnv':{'VideoParam':{'stColor': {'rg':158},'nChannel':0}}}}	bg	[[0, 255]			
Saturation	{'SetEnv':{'VideoParam':{'stColor': {'saturation':0},'nChannel':0}}}}	saturation	[0, 14]			
Hue	{'SetEnv':{'VideoParam':{'stColor': {'hue':14},'nChannel':0}}}}	hue	[0, 14]			
AWB Sensitivity	{'SetEnv':{'VideoParam':{'stColor': {'awbsens':0},'nChannel':0}}}}	awbsens	0: Low	2: High		
			1: Middle			

Image				
Bright	{'SetEnv':{'VideoParam':{'stImg':{'luminance':0},'nChannel':0}}}	luminance	[0, 4]	
Contrast	{'SetEnv':{'VideoParam':{'stImg':{'contrast':0},'nChannel':0}}}	contrast	[0, 14]	
Sharpness	{'SetEnv':{'VideoParam':{'stImg':{'sharpness':1},'nChannel':0}}}	sharpness	[0, 15]	
Gamma	{'SetEnv':{'VideoParam':{'stImg':{'gamma':0},'nChannel':0}}}	gamma	[0, 4]	0: Default 1: 0.45 2: 0.50 3: 0.55 4: 0.63
DCI	{'SetEnv':{'VideoParam':{'stImg':{'dci':0},'nChannel':0}}}	dci	[0, 8] 0:	OFF
B&W Mode	{'SetEnv':{'VideoParam':{'stImg':{'nBWMode':0},'nChannel':0}}}	nBWMode	0: 4:	Color B & W
Flip-H	{'SetEnv':{'VideoParam':{'stImg':{'nFlipH':3},'nChannel':0}}}	nFlipH	2: 3:	ON OFF

Camera Settings				
Image				
Function	Code	Command	Setting	
Flip-V	{'SetEnv':{'VideoParam':{'stImg':{'nFlipV':2},'nChannel':0}}}	nFlipV	2: 3:	ON OFF
AutoFlip	{'SetEnv':{'VideoParam':{'stImg':{'nAutoFlipV':2},'nChannel':0}}}	nAutoFlipV		ON OFF
DZoom	{'SetEnv':{'VideoParam':{'stImg':{'nEZoom':3},'nChannel':0}}}	nEZoom	2: 3:	ON OFF
HDR	{'SetEnv':{'VideoParam':{'stImg':{'hdr':3},'nChannel':0}}}	hdr	2: 3:	ON OFF

## Noise Reduction

Camera Settings				
Function	Code	Command	Setting	
NR-2D	{'SetEnv':{'VideoParam':{'stNR':{'noise2D':0},'nChannel':0}}}	noise2D	[0, 8]	
NR-3D	{'SetEnv':{'VideoParam':{'stNR':{'noise3D':0},'nChannel':0}}}	noise3D	[0, 11]	0: OFF 8: Auto
Dynamic Hot Pixel	{'SetEnv':{'VideoParam':{'stNR':{'dhotpixel':3},'nChannel':0}}}	dhotpixel	[0, 5]	0: OFF
Style	{'SetEnv':{'VideoParam':{'stColor':{'nStyleInx':0},'nChannel':0}}}	nStyleInx	[0, 4]	0: Default 1: Normal 2: Clarity 3: Bright 4: Soft

## Video OSD

Video OSD	
<b>Get video parameters</b>	
Code	{'GetEnv':{'VideoOsd':{'nChannel':-1}}}
<b>Set set video parameters</b>	
Code	{'SetEnv':{'VideoOsd':[{ 'stTime':{'bEnable':1,'nIndex':0,'nXPos':0,'szText':'','nYPos':10000,'stFtColor':{'byAlpha':128,'byRed':255,'byGreen':255,'byBlue':255},'stBkColor':{'byAlpha':0,'byRed':0,'byGreen':0,'byBlue':0}},{'stTitle':{'bEnable':0,'nIndex':0,'nXPos':0,'szText':'','nYPos':0,'stFtColor':{'byAlpha':128,'byRed':255,'byGreen':255,'byBlue':255},'stBkColor':{'byAlpha':0,'byRed':0,'byGreen':0,'byBlue':0}},'nChannel':0}}]}
<b>NOTE: All params can be saved by this command and also you can set one param alone.</b>	

Function	Code	Command	Setting
Show Time	{'SetEnv':{'VideoOsd':[{ 'stTime':{'bEnable':1,'nChannel':0}}]}	bEnable	0: Not show 1: Show
Show Title	{'SetEnv':{'VideoOsd':[{ 'stTitle':{'bEnable':1,'nChannel':0}}]}	bEnable	0: Not Show 1: Show

Video OSD			
Set video parameters			
Function	Code	Command	Setting
Time FontColor	{'SetEnv':{'VideoOsd':[{ 'stTime':{'stFtColor':{'byAlpha':128,'byRed':255,'byGreen':255,'byBlue':0}},'nChannel':0}}]}	byAlpha	128
		white	rgb (255,255,255)
		black	rgb (0,0,0)
		yellow	rgb (255,255,0)
		red	rgb (255,0,0)
		blue	rgb (0,0,255)
Title FontColor	{'SetEnv':{'VideoOsd':[{ 'stTitle':{'stFtColor':{'byAlpha':128,'byRed':255,'byGreen':255,'byBlue':0}},'nChannel':0}}]}	byAlpha	128
		white	rgb (255,255,255)
		black	rgb (0,0,0)
		yellow	rgb (255,255,0)
		red	rgb (255,0,0)
		blue	rgb (0,0,255)
OSD Offsetx pos	Time: {'SetEnv':{'VideoOsd':[{ 'stTime':{'nXPos':9200,'nChannel':0}}]}	nXPos	[0, 10000]
OSD Offsetx pos	Title: {'SetEnv':{'VideoOsd':[{ 'stTitle':{'nXPos':9200,'nChannel':0}}]}	nXPos	[0, 10000]
OSD Offsety pos	Time: {'SetEnv':{'VideoOsd':[{ 'stTime':{'nYPos':1200,'nChannel':0}}]}	nYPos	[0, 10000]
	Title: {'SetEnv':{'VideoOsd':[{ 'stTitle':{'nYPos':1200,'nChannel':0}}]}		

OSD Font Size			
Get OSD font size parameters			
Code	{\"GetEnv\":{\"TTFontSize\":{\"nChannel\":-1}}}		
Set video parameters			
Code	{\"SetEnv\":{\"TTFontSize\":{\"nFontSize\":[48,48],\"bAutoSize\":1}}}		
Function	Code	Command	Setting
		bAutoSize	0: off, 1: on
		nFontSize	[8,200]

## Output Format

(Video) Output Format				
Get video out parameters				
Code	{\"GetEnv\":{\"VideoOut\":{\"nChannel\":-1}}}			
Set video out parameters				
Code	{\"SetEnv\":{\"VideoOut\":{\"nNetMode\":2,\"emVoutSdiFormat\":10,\"nHdmiMode\":0,\"nHdrMode\":0,\"emVoutHdmiFormat\":10,\"byFormaHdmiList\":[50,52,49,47,51,48,10,20,9,8,21,7,4,22,3,6,23,5],\"byFormaSdiList\":[10,20,9,8,21,7,4,22,3,6,23,5]}}}			
Function	Code	Command	Setting	
		nNetMode: default value 2, <b>do not modify it</b>	– HD output – HD output + SD network – SD output + HD network	
		<b>Command</b>		
		emVoutHdmiFormat: Setting video out format.	emVoutSdiFormat: Setting SDI video out format.	
		Setting	Result	Setting
		50:	4K60	
		52:	4KP59	
		49:	4K50	
		47:	4K30	
		51:	4KP29	
		48:	4KP25	
		10:	1080P60	Same as Hdmi
		20:	1080P59	Same as Hdmi
		9:	1080P50	Same as Hdmi
		8:	1080I60	Same as Hdmi
		21:	1080I59	Same as Hdmi
		7:	1080I50	Same as Hdmi
		4:	1080P30	Same as Hdmi

(Video) Output Format				
		22:	1080P29	Same as Hdmi
		3:	1080P25	Same as Hdmi
		6:	720P60	Same as Hdmi
		23:	720P59	Same as Hdmi
		5:	720P50	Same as Hdmi

## SRT

SRT			
Get network SRT parameters			
Code	{'GetEnv':{'NetWork':{'nChannel':-1}}}		
Set network SRT parameters			
Code	{'SetEnv':{'NetWork':{'stSrt':{'wSrtLen':0,'wSrtPort':9000,'szSrtPin':'xxxxxxxx'}}}}		
Function	Code	Command	Setting
crypto key length in bytes		wSrtLen	[0-32]
Port SRT		wSrtPort	Default 9000
Password stream encryption		szSrtPin	user-defined

## Network

### Network configure and port settings

Network Configure			
Get network port parameters			
Code	{'GetEnv':{'NetWork':{'nChannel':-1}}}		
Set network port parameters			
Code	{'SetEnv':{'NetWork':{'stNetPort':{'wPortSoap':1936,'wPortData':3000,'wPortWeb':80,'wPortRtsp':554,'wPortVisca':1259,'wPortOnvif':2000,'wPortRtmp':1935,'wPortHttps':443}}}}		
	You can also set one of these parameters like this: {'SetEnv':{'NetWork':{'stNetPort':{'wPortSoap':1936}}}}		
Port Settings			
Function	Code	Command	Setting
Port Data		wPortData	[0, 65535]
Port Web		wPortWeb	[0, 65535]
Port Onvif		wPortOnvif	[0, 65535]
Port Https		wPortHttps	{0, 65535}
Port Soap		wPortSoap	[0, 65535]
Port Rtmp		wPortRtmp	[0, 65535]
Port Rtsp		wPortRtsp	[0, 65535]
Port Visca		wPortVisca	[0, 65535]

## Ethernet

Ethernet			
Get Ethernet parameters			
Code	{\"GetEnv\":{\"NetWork\":{\"nChannel\":-1}}}		
Set Ethernet parameters			
Code	\"SetEnv\":{\"NetWork\":{\"stEth\":{\"byValid\":5,\"szIPAddr\":\"192.168.5.126\",\"szSubMask\":\"255.255.255.0\",\"szMacAddr\":\"E4:77:D4:01:8A:49\",\"szGateway\":\"192.168.5.1\",\"bDefault\":1}}}}		
Function	Code	Command	Setting
DHCP	{\"SetEnv\":{\"NetWork\":{\"stEth\":{\"byValid\":5}}}}	byValid	5:off 7:on
IP Address	{\"SetEnv\":{\"NetWork\":{\"stEth\":{\"szIPAddr\":\"192.168.5.127\"}}}}		
Subnet Mask	{\"SetEnv\":{\"NetWork\":{\"stEth\":{\"szSubMask\":\"255.255.255.0\"}}}}		
Default Gateway	{\"SetEnv\":{\"NetWork\":{\"stEth\":{\"szGateway\":\"192.168.5.1\"}}}}		

## DNS

DNS			
Get dns parameters			
Code	{\"GetEnv\":{\"NetWork\":{\"nChannel\":-1}}}		
Set dns parameters			
Code	{\"SetEnv\":{\"NetWork\":{\"stDns\":{\"szDns1\":\"8.8.8.8\",\"szDns2\":\"0.0.0.0\"}}}}		
Function	Code	Command	Setting
Preferred DNS Server	{\"SetEnv\":{\"NetWork\":{\"stDns\":{\"szDns1\":\"8.8.8.8\"}}}}		
Alternative DNS Server	{\"SetEnv\":{\"NetWork\":{\"stDns\":{\"szDns2\":\"8.8.8.8\"}}}}		

## System

System Configure			
Get sysattr parameters			
Code	{\"GetEnv\":{\"SysAttr\":{\"nChannel\":-1}}}		
Set sysattr parameters			
Code	{\"SetEnv\":{\"SysAttr\":{\"nLanguage\":0,\"szDeviceID\":\"1\",\"emVideoStandard\":1,\"szDevName\":\"testname\"}}}		
Function	Code	Command	Setting
Device Name		szDevName	user-defined, cannot use white space
Device ID		szDeviceID	cannot modify
Language		nLanguage	0: Simplified Chinese 2: English



## Time

SysTime	
<b>Get system time parameters</b>	
Code	{'QueryState':{'QuerySysTime':{}}}
<b>Set system time parameters</b>	
Code	{'SetEnv':{'SysTime':{'nDateSprtr':2,'nDateFormat':0,'nZone':1,'nHourType':0,'stNtp':{'bEnable':1,'nHostPort':123,'nUpdateInterval':2,'szHostUrl':'ntp4.aliyun.com'}}}}

Function	Code	Command	Setting
Date Format	{'SetEnv':{'SysTime':{'nDateFormat':0}}}	nDateFormat	0: YYYY-MM-DD 1: MM-DD-YYYY 2: DD-MM-YYYY
Date Sprtr	{'SetEnv':{'SysTime':{'nDateSprtr':0}}}	nDateSprtr	0: . 1: - 2: /

SysTime			
Function	Code	Command	Setting
Zone	{'SetEnv':{'SysTime':{'nZone':0}}}	nZone	[0, 32] 0: GMT 1: GMT+01:00 2: GMT+02:00 3: GMT+03:00 4: GMT+03:30 5: GMT+04:00 6: GMT+04:30 7: GMT+05:00 ..... 13: GMT+08:00 ..... 20: GMT-01:00 ..... 31: GMT-11:00 32: GMT-12:00

SysTime			
Hour Type	{'SetEnv':{'SysTime':{'nHourType':0}}}	nHourType	0: 24 Hours    1: 12 Hours
NTP Enable	{'SetEnv':{'SysTime':{'stNtp':{'bEnable':1}}}}	bEnable	0: off    1: on
Update Interval	{'SetEnv':{'SysTime':{'stNtp':{'nUpdateInterval':2}}}}	nUpdateInterval	[1, 10]
Host URL	{'SetEnv':{'SysTime':{'stNtp':{'szHostUrl':'time.nist.gov'}}}}	szHostUrl	user-defined, ntp server address
Host Port	{'SetEnv':{'SysTime':{'stNtp':{'nHostPort':123}}}}	nHostPort	user-defined: [0, 65535]
Time Settings	{'SysCtrl':{'SetTime':{'bTimeType':1,'nZone':19,'stDateTime':{'dwYear':2018,'byHour':15,'byMinute':38,'byDay':1,'byMonth':11,'bySecond':2}}}}		Synchronize with computer time or set manual:
Synchronize NTP Server	{'SysCtrl':{'SyncNtp':''}}		

## User

SysUser			
<b>Get sysuser parameters</b>			
Code	{!GetEnv:{"SysUser":{}}}		
<b>Set sysuser parameters</b>			
Code	{!SetEnv:{"SysUser":{"stUsers":{"nUserType":0,"szUserName":"admin","szPassword":"admin"}, {"nUserType":1,"szUserName":"user1","szPassword":"user1"}, {"nUserType":1,"szUserName":"user2","szPassword":"user2"}}}}		
Function	Code	Command	Setting
Authority		nUserType	0: admin 1: user1 or user 2
User Name		szUserName	user-defined: no white space
Password		szPassword	user-defined, no white space. This command must set three users at the same time.

## Update

Update	
<b>Get update parameters</b>	
Code	{!QueryState:{"QueryVersion":{}}}
Code	Get the return value and split it like this: szText.Format("%d.%d.%d-%d-%d", (stVersion.dwCamVersion >> 16) & 0xFF, (stVersion.dwCamVersion >> 8) & 0xFF, (stVersion.dwCamVersion & 0xFF), (stVersion.dwCamDate >> 16) & 0xFFFF, (stVersion.dwCamDate >> 8) & 0xFF, (stVersion.dwCamDate & 0xFF));
<b>Set update parameters</b>	Not supported update with API, you can do this through webpage.

## Default and Reboot

Default	
Code	{!SysCtrl:{"Default":{}}}
Reboot	
Code	{!SysCtrl:{"Reboot":{}}}



The URL supports to set all params at one time and also can set one of them through split URL into one other command. Different commands can be found at different settings.

## APPENDIX D - CMOS SENSOR CHARACTERISTICS

The following occurrences that may appear in images are specific to CMOS (Complementary Metal Oxide Semiconductor) image sensors. They do not indicate malfunctions.

### White Flecks

Although the CMOS image sensors are produced with high-precision technologies, fine white flecks may be generated on the screen in rare cases. These flecks are caused by natural and / or artificial radiation, which causes a “false exposure” on the image sensor. The shape of these spots may vary from dots to lines or other —sometimes irregular— shapes. These spots occur in random locations of the image, occur only in a single frame and are more visible in dark images. This is a principle issue of all image sensors and **is not a malfunction**.

The white flecks especially tend to be seen in the following cases:

- When operating at a high ambient temperature
- When you have raised the gain (sensitivity)

The white flecks may be reduced by turning the camera off, then on again.

### Aliasing

When fine patterns, stripes, or lines are shot, they may appear jagged or flickering. **Aliasing** refers to the effect that is produced when a signal is imperfectly reconstructed from the original signal. It occurs when a signal is not sampled at a high enough frequency to create an accurate representation.

This effect is shown in the following example of a **sinusoidal function**:

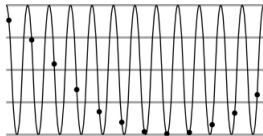

In this example, the dots represent the sampled data and the curve represents the original signal. Because there are not enough sampled data points, the resulting pattern produced by the sampled data is a poor representation of the original.

### Focal Plane

Owing to the characteristics of the pickup elements (CMOS image sensors) for reading video signals, subjects that quickly move across the screen may appear slightly skewed (i.e., tilted to the left or right, depending on the direction of camera or subject movement). Since a CMOS sensor typically captures one row at a time within approximately 1/60th or 1/50th of a second (depending on the refresh rate), it may result in a “rolling shutter” effect. In such cases, the image is skewed.

### Flash Band

If you film a strobe or quick-flashing light, brightness may differ between the upper and lower halves of the picture. See the Focal Plane explanation above for a clarification of this occurrence.

### Flicker

If you are recording under lighting that is produced by discharge tubes (such as fluorescent, sodium or mercury-vapor lamps), the screen may flicker, colors may vary, or horizontal stripes may appear distorted. In such cases, set the anti-flicker setting to 'on'. Depending on lighting types, such occurrences may not be improved with the anti-flicker setting.



It is recommended to set the shutter speed to 1/100s in areas of 50 Hz power supply frequency, and to 1/60s in areas of 60 Hz power supply frequency.

# APPENDIX E - DATASHEET (SPECIFICATIONS)

## SPECIFICATIONS

### Camera

<b>Video Systems HDMI</b>	2160p60, 2160p59, 2160p50, 2160p30, 2160p25, 1080p60, 1080p59, 1080p50, 1080i60, 1080i59, 1080i50, 1080p30, 1080p29, 1080p25, 720p60, 720p59, 720p50
<b>Video Systems SDI</b>	1080p60, 1080p59, 1080p50, 1080i60, 1080i59, 1080i50, 1080p30, 1080p29, 1080p25, 720p60, 720p59, 720p50
<b>Sensor</b>	Sony 1/1.8", 8.42MP, 16:9 High SNR CMOS Sensor
<b>Shutter</b>	Auto/ Manual 1/60th ~ 1/10000th
<b>Scanning mode</b>	Progressive/ Interlace
<b>Zoom/Aperture/Focal length</b>	30x zoom*/ F1.6 ~ F11/ 7mm ~ 172mm (+/-5%)
<b>Minimal Illumination</b>	0.05LUX @F1.6
<b>White Balance</b>	Auto, Manual, One Push, Manual 2400 ~ 7100K in 100K steps
<b>Backlight Compensation</b>	supported
<b>Digital Noise Reduction</b>	supported
<b>Signal Noise Ratio</b>	>50 dB
<b>Horizontal FOV</b>	59.2° - 2.5°
<b>Vertical FOV</b>	34.6° - 1.4°
<b>Horizontal rotation</b>	+/- 170°
<b>Vertical rotation</b>	120° (30° down, 90° up)
<b>Pan speed range</b>	0.15° ~ 120° p/sec
<b>Tilt speed range</b>	0.15° ~ 70° p/sec
<b>H&amp;V image flip</b>	supported
<b>Number of presets</b>	255 with 0.1° accuracy
<b>Control over IP</b>	Visca over IP, HTTP API
<b>Control over Serial</b>	Visca, Pelco
<b>Control over IR</b>	IR remote control

### IP Features

<b>Video coding standard</b>	H.265 / H.264 / MJPEG
<b>H.265 Profiles</b>	main
<b>H.264 Profiles</b>	base, main, high
<b>Main stream resolution</b>	1920x1080/ 1280x720/ 3840x2160
<b>Main stream max framerate</b>	60fps
<b>Main stream bitrate</b>	64 ~ 81920 Kbps
<b>Sub stream resolution</b>	1920x1080/ 720x480/ 640x480/ 640x360/ 320x240
<b>Sub stream max framerate</b>	30fps max
<b>Sub stream bitrate</b>	64 ~ 5120 Kbps
<b>Video bitrate type</b>	CBR, VBR
<b>Supported protocols</b>	RTSP, RTMP, ONVIF, SRT, Multicast, Unicast
<b>Audio standard</b>	AAC
<b>Audio bitrate</b>	32, 64, 96, 128 Kbps
<b>Audio sample rate</b>	48Khz
<b>Audio line in</b>	balanced audio by 5-way Phoenix connector

### Input / Output Interface

<b>HDMI output</b>	HDMI 2.0 up to 4K60
<b>SDI output</b>	3G-SDI, 1080p60 max.
<b>USB Output</b>	USB2.0 Type B, 2160p30 max.
<b>Network interface</b>	RJ45 1 Gb.
<b>Serial interface</b>	RS232 mini DIN-8, RS485 2-pin phoenix

### General Specifications

<b>Input Voltage</b>	12V
<b>PoE</b>	PoE 802.3AT (PoE+) at 18 watt
<b>Power consumption</b>	18W
<b>Power supply</b>	12V2A
<b>Power connector</b>	EIAJ-4 - Philmore 255 plug
<b>Operating temperature</b>	-5°C ~ 35°C
<b>Storage temperature</b>	-20°C ~ 60°C
<b>Operating humidity</b>	20% ~ 95% non-condensing
<b>Bottom fastening screw thread</b>	1/4" 20 UNC
<b>Color</b>	Black, White
<b>Dimensions product wxhxd</b>	300 x 235 x 300mm
<b>Weight product</b>	2.5 kg
<b>Dimensions box</b>	30 x 30 x 24 cm
<b>Weight box</b>	3.4 kg
<b>Included</b>	power adapter, remote control, RS232 cable, RS485 2-way Phoenix connector, Balanced Audio, Line-In 5-way Phoenix connector

### Versions

<b>Black</b>	CM93-IP-B • CM93-NDI-B
<b>White</b>	CM93-IP-W • CM93-NDI-W

### CM93-NDI Only

<b>NDI standard</b>	NDI®   HX
---------------------	-----------

\*Avonic's Optimal Zoom

# Index

## A

AAE Mode (Aperture Auto Exposure) 31, 82  
AF Mode 28  
AF Sensitivity 29, 49, 64, 81  
AF Tactics 49  
AF Version 38, 50, 90  
AF Zone 65, 81  
Audio 24, 77  
Auto Exposure Mode 29  
AWB Mode 48  
AWB Sensitivity 32, 48, 64, 83

## B

Balanced Audio 15  
Baudrate 17, 39, 47  
BG Tuning 32, 48, 55, 62, 65, 83  
BLC (Back Light Compensation) 29, 44, 48, 63, 81  
Bright 62  
Bright (Exposure) Mode 32, 82  
BW (Black and White) Mode 33, 48, 84

## C

Camera Version 38, 50, 90  
CAT 15  
CBR 25  
CMOS 91  
Color 22, 23, 32, 48, 55, 83  
COM port 17  
Contrast 33, 64, 84  
Controller 16, 17, 18, 46

## D

DC12V 15  
DCI (Dynamic Contrast) 33, 84  
Device ID 37, 88  
Device Name 37, 88  
DHCP 19, 50, 88  
DNS Server 37, 88  
DRC (Dynamic Range Compression) 29, 30, 48, 81  
Dynamic Hot Pixel 63, 84  
DZoom (Digital Zoom) 33, 48

## E

Ethernet 37, 88  
EV (Exposure Value) 29, 48  
EV (level) 62, 81  
Export Configuration 40  
Exposure 22, 23, 29, 48, 55, 62, 81

## F

Factory Reset 39, 50, 64, 90  
Firmware 38, 50, 56, 65, 90  
Flicker 29, 55, 63, 81, 91  
Flip-H, Flip-V 48  
Flip-H, Flip-V, Autoflip 33, 63, 64, 84  
Focus 21, 23, 28, 28, 43, 49, 56, 61, 76, 81

## G

G.Limit (Gain Limit) 29, 48, 62, 81  
Gamma 84  
Gateway 50

## H

H264 20, 25, 27, 34  
H265 25  
HDMI 15, 16, 16, 35, 44, 46, 50, 51  
HDR 48  
HTTP API 72  
HTTP Basic Authentication 38  
Hue 48, 65, 83

## I

Image 22, 23, 33  
Image Freezing 41, 49, 63, 76  
Import Configuration 40  
IP Address 18, 19, 50, 72, 88  
IR Remote Control 16, 42, 45, 46, 56, 75  
IR Remote Control Keys 42, 45  
Iris 30, 48, 55, 62, 82

## K

Kensington Lock 15

## L

LAN 16, 18, 37, 38  
Language 37, 47, 88  
Login 19  
Low Light Mode 48  
Low Power Mode 41, 49, 76

## M

Manual Exposure Mode 30  
Mask 50  
MCU Version 38, 50, 65, 90  
Mini DIN-8 17  
MJPEG 41  
Multicast 26, 80

## N

Network 36, 50, 56, 87  
Noise Reduction 22, 23, 33, 49, 55, 84  
NR-2D 63, 84  
NR-3D 63, 84

## O

OSD (On Screen Display) 34, 44, 46, 85

## P

Password 18, 19, 38, 80, 90

PELCO-D [39, 47](#)  
PELCO-P [39, 47](#)  
PoE [15, 18](#)  
Port [36](#)  
Power [61](#)  
Preset [41, 44, 49, 65, 76, 77](#)  
PTZ [20, 41, 44, 49, 64, 75](#)

## R

Reboot [39, 90](#)  
Reboot Schedule [39](#)  
Reset IP configuration (IP Address, Gateway, DNS server) [39](#)  
RG Tuning [32, 48, 55, 62, 65, 83](#)  
RJ45 [15](#)  
RS-232 [15, 16, 17, 56, 57](#)  
RS-485 [15, 16, 17, 18, 56](#)  
RTMP [26](#)  
RTP [25, 26, 80](#)  
RTSP [25](#)

## S

SAE Mode (Shutter Auto Exposure) [31, 82](#)  
Saturation [48, 83](#)  
SDI [15, 16, 16, 35, 44, 46, 50, 51](#)  
Serial [16, 39](#)  
Sharpness [33, 63, 84](#)  
Shutter [30, 48, 62, 82](#)  
Speed by Zoom [41, 49, 76](#)  
SRT [26, 35, 72, 80, 87](#)  
Style [34, 49, 84](#)  
System Select [15, 51](#)

## T

Tally Light [45, 65](#)  
TCP [18, 57](#)  
Time and Date [38, 85, 89](#)

## U

UDP [18, 57](#)  
Unicast [26](#)  
USB [15, 16, 16](#)  
Username [18, 19, 38, 80, 90](#)  
UVC Version [65](#)

## V

VBR [25](#)  
Video Encoder [25, 78](#)  
Video Format [35, 50, 51, 66, 86](#)  
Video Streaming [26, 79](#)  
VISCA [39, 47, 56, 57](#)  
VISCA over IP [18, 57](#)

## W

Wall and Ceiling Mount (AV-MT300) [14](#)  
WB (White Balance) Mode [32, 48, 55, 61, 83](#)  
WebGUI [19, 56](#)

## X

XLR [15, 24](#)

## Z

Zoom [43, 61](#)  
Zoom Speed [41, 49, 76](#)



Avonic 4K60 PTZ Camera 30x Zoom  
CM93-IP

© February 2023 • Version 1.0