

CR-KP1 & CR-KP2

15 or 9 Button Wall-Mount Keypad Control Systems

OPERATION MANUAL

DISCLAIMERS

The information in this manual has been carefully checked and is believed to be accurate. CYP (UK) Ltd assumes no responsibility for any infringements of patents or other rights of third parties which may result from its use.

CYP (UK) Ltd assumes no responsibility for any inaccuracies that may be contained in this document. CYP (UK) Ltd also makes no commitment to update or to keep current the information contained in this document.

CYP (UK) Ltd reserves the right to make improvements to this document and/or product at any time and without notice.

COPYRIGHT NOTICE

No part of this document may be reproduced, transmitted, transcribed, stored in a retrieval system, or any of its part translated into any language or computer file, in any form or by any means—electronic, mechanical, magnetic, optical, chemical, manual, or otherwise—without express written permission and consent from CYP (UK) Ltd.

© Copyright 2011 by CYP (UK) Ltd.

All Rights Reserved.

Version 1.1 August 2011

TRADEMARK ACKNOWLEDGMENTS

All products or service names mentioned in this document may be trademarks of the companies with which they are associated.

SAFETY PRECAUTIONS

Please read all instructions before attempting to unpack, install or operate this equipment and before connecting the power supply.

Please keep the following in mind as you unpack and install this equipment:

- Always follow basic safety precautions to reduce the risk of fire, electrical shock and injury to persons.
- To prevent fire or shock hazard, do not expose the unit to rain, moisture or install this product near water.
- Never spill liquid of any kind on or into this product.
- Never push an object of any kind into this product through any openings or empty slots in the unit, as you may damage parts inside the unit.
- Do not attach the power supply cabling to building surfaces.
- Use only the supplied power supply unit (PSU). Do not use the PSU if it is damaged.
- Do not allow anything to rest on the power cabling or allow any weight to be placed upon it or any person walk on it.
- To protect the unit from overheating, do not block any vents or openings in the unit housing that provide ventilation and allow for sufficient space for air to circulate around the unit.

REVISION HISTORY

VERSION NO.	DATE	SUMMARY OF CHANGE
v1.00	23/01/2017	First release

CONTENTS

1. Introduction	6
2. Applications	6
3. Package Contents	6
4. System Requirements	7
5. Features	7
6. Operation Controls and Functions	8
6.1 Front Panel	8
6.2 Rear Panel.....	9
6.3 Telnet Commands	10
6.4 Telnet Control.....	13
6.5 WebGUI Control	15
7. Connection Diagram	25
7.1 Option 1	25
7.2 Option 2	26
8. Specifications	27
9. Acronyms	29

1. INTRODUCTION

These keypads are versatile and useful products for both system integrators and smart home users alike. These keypads can send commands to any Ethernet or relay trigger controlled device in your system. With up to 15 physical macro buttons and up to an additional 15 software macro buttons (9 each on the single gang version) you can pre-program and recall up to 30 (18 on the single gang version) distinct macros providing for complete control over your audio and video environment.

The soft and colourful LED buttons are suitable for all environments and PoE (Power over Ethernet) support allows for creative placement of the keypad within your space without needing to be concerned about keeping it near a live power source. Additionally, the integrated clock and calendar based scheduling feature allows you to trigger macros to control devices within your installation at a specific time, or on a recurring schedule.

2. APPLICATIONS

- /// Smart Home Control
- /// Control Center
- /// Function Room
- /// Product Showroom
- /// Ballroom

3. PACKAGE CONTENTS

- /// 1× Control Keypad (UK double gang or single gang)
- /// 1× USB Type A to USB Mini-B OTG Connector
- /// 2× Terminal Block Connectors (1 with the single gang version)
- /// 2× Button Sticker Sheets
- /// 1× 5V/2.6A DC Power Adaptor
- /// 1× Operation Manual

4. SYSTEM REQUIREMENTS

- /// An active Internet connection from a switch or router for control of Ethernet devices.
- /// A PoE supporting network switch or hub is required to use the PoE power function, otherwise access to a local power outlet is needed.

5. FEATURES

- /// UK double or single gang wall plate design with adjustable LED brightness
- /// 30 (18 on the single gang) macros for controlling user equipment
- /// Up to 128 total commands can be stored and used across all macros in the system (up to 16 per macro)
- /// Supports relay triggers to control compatible devices
- /// Supports time and date macro scheduling (single and recurring)
- /// Supports 48 hours of backup power for the internal clock and schedule function to protect against blackouts and temporary power loss
- /// Supports customisable daylight savings time settings for scheduling
- /// Supports Keypad, Telnet and WebGUI control
- /// Supports PoE or DC power supply
- /// Multiple uses for home, hotel rooms, central control rooms, conference rooms, etc.

6. OPERATION CONTROLS AND FUNCTIONS

6.1 Front Panel

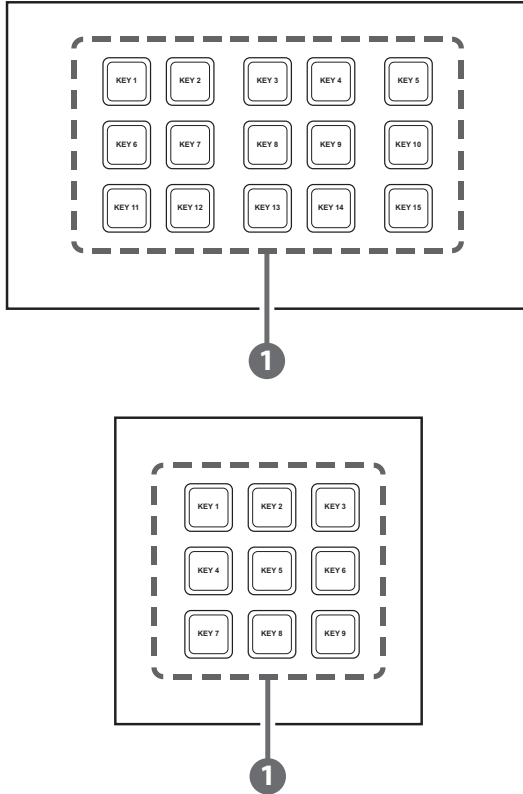

- 1 Macro Buttons:** Each button contains 2 colour LEDs (red and blue) with adjustable individual brightness levels from 0~100. Each button can activate a customised macro. (For further detail on these settings please refer to section 6.5 "WebGUI Control".)

6.2 Rear Panel

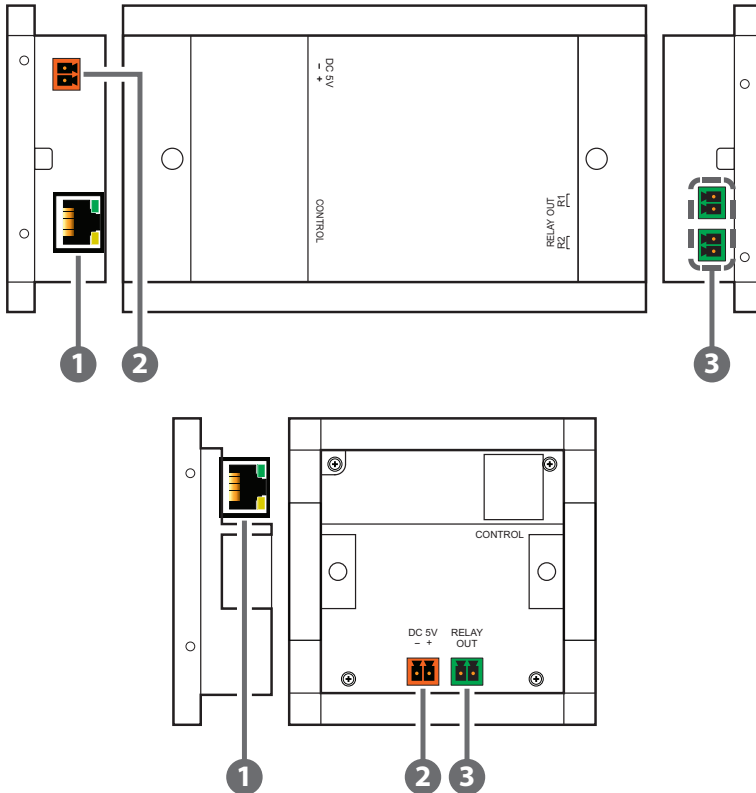

- 1 CONTROL:** Connect to an active Ethernet network via a switch or router to allow it to control other devices on the network and to be accessed via Telnet/WebGUI. This unit has PoE (48V, PD) functionality which means it can be powered directly by a connected PoE (48V, PSE) switch/hub without the need for a power adapter.
- 2 DC 5V:** Plug the 5V DC power adapter into this port and connect it to an AC wall outlet for power. (optional)
- 3 RELAY OUT:** Connect to a device that supports DC 0~24V/5A relay trigger functionality.

6.3 Telnet Commands

COMMAND	DESCRIPTION
IPCONFIG	Display the current IP configuration.
SETIP N, N1,N2	Set static Ethernet IP, netmask, and gateway addresses simultaneously. N=X.X.X.X (IP Address) N1=X.X.X.X (Netmask) N2=X.X.X.X (Gateway) X=0~255
SIPADDR X.X.X.X	Set Ethernet IP address. X=0~255
SNETMASK X.X.X.X	Set Ethernet netmask. X=0~255
SGATEWAY X.X.X.X	Set Ethernet gateway. X=0~255
SIPMODE N	Set Ethernet IP mode. N=STATIC, DHCP
VER	Show unit's firmware version.
FADEFAULT	Set all configurations to factory defaults.
ETH_FADEFAULT	Reset all Ethernet settings to the factory defaults.
REBOOT	System reboot.
HELP (?)	Show command list.
HELP N	Show description of command. N={Command Name}

COMMAND	DESCRIPTION
RELAY N N1	Relay control. N=1~2 (Port) N1=OPEN, CLOSE, TOGGLE
LEDBLUE N N1	Individual blue LED brightness control. N=1~15 (LED Number) N1=0~100 (%)
LEDRED N N1	Individual red LED brightness control. N=1~15 (LED Number) N1=0~100 (%)
LEDBLUES N	Set the brightness of all blue LEDs. N=0~100 (%)
LEDREDS N	Set the brightness of all red LEDs. N=0~100 (%)
LEDSHOW N	LED demo mode control. N=ON, OFF, TOGGLE
BACKLIGHT N	Set the brightness of all LEDs. N=0~100 (%)
KEY_PRESS N RELEASE	Set key press macro activation method to "Release". (Macro activates a single time upon key release.) N=1~15 (Key Number)

COMMAND	DESCRIPTION
KEY_PRESS N HOLD	Set key press macro activation method to "Hold". (Macro activates when key is pressed. Macro will repeat as long as the key is held down.) N=1~15 (Key Number)
MACRO RUN N	Run the specified macro. N=1~30 (Macro ID)
MACRO STOP	Stop all currently running macros.
MACRO STOP N	Stop the specified macro. N=1~30 (Macro ID)
DEVICE ADD N N1 N2 N3	Add Telnet device definition to slot N. N=1~16 (Device Slot Number) N1=X.X.X.X (IP Address, X=0~255) N2=0~65535 (Port) N3={Name} (Up to 24 characters, no spaces)
DEVICE DELETE N	Delete Telnet device definition in slot N. N=1~16 (Device Slot Number)
DEVICE N N1	Enable/Disable defined Telnet device. N=ENABLE, DISABLE N1=1~16 (Device Slot Number)

Note: Commands will not be executed unless followed by a carriage return. Commands are not case-sensitive.

6.4 Telnet Control

Before attempting to use Telnet control, please ensure that both the unit and the PC/Laptop are connected to the same active networks.

To access Telnet in Windows 7, click on the “Start” menu and type “cmd” in the search field, then press “Enter”. Under Windows XP go to the “Start” menu, click on “Run”, type “cmd” then press “Enter”. Under Mac OS X, go to “Go→Applications→Utilities→Terminal”. See below for reference.

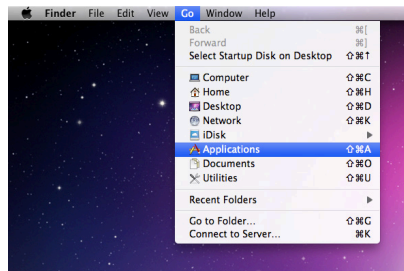
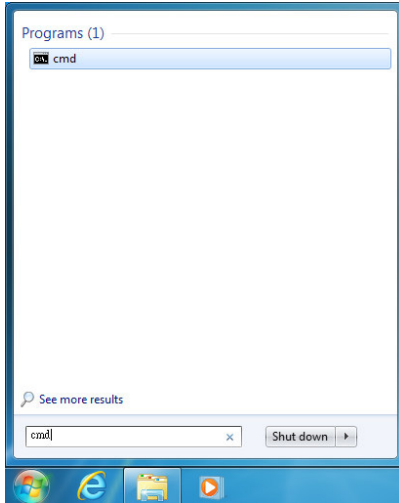

Once in the CLI (Command Line Interface) type “Telnet” followed by the IP address of the unit and “23”, then hit “Enter”.

```
Microsoft Windows [Version 6.1.7601]
Copyright (c) 2009 Microsoft Corporation. All rights reserved.

C:\Users\Administrator>telnet 192.168.5.80 23
```

This will connect us to the unit we wish to control. Type "help" to list the available commands.

```
HELP          : SHOW DESCRIPT OF COMMAND
               USE <HELP N, N=COMMAND NAME> TO SHOW DESCRIPT OF COMMAND
?            : SHOW DESCRIPT OF COMMAND
               USE <? N, N=COMMAND NAME> TO SHOW DESCRIPT OF COMMAND
IPCONFIG      : DISPLAY THE CURRENT IPCONFIG
SETIP        : SET ETHERNET IP, NETMASK AND GATEWAY ADDRESS
SIPADDR      : SET ETHERNET IP ADDRESS
SMETMASK     : SET ETHERNET NETMASK
SGATEWAY     : SET ETHERNET GATEWAY
SIPMODE      : SET ETHERNET IP MODE
UER          : SHOW UNIT FIRMWARE VERSION
FADEFAULT    : ALL CONFIGURE SET TO FACTORY DEFAULT
ETH_FADEFAULT : ALL ETHERNET CONFIGURE SET TO FACTORY DEFAULT
REBOOT       : SYSTEM REBOOT
LEDBLUES    : ALL BLUE LED BACKLIGHT CONTROL
LEDRS       : ALL RED LED BACKLIGHT CONTROL
LEDBLUE     : LED BLUE BACKLIGHT CONTROL
LEDR        : LED RED BACKLIGHT CONTROL
RELAY       : RELAY CONTROL
KEY_PRESS    : KEY PRESS TRIGGER TYPE
MACRO       : MACRO CONTROL
BACKLIGHT    : ALL LED BACKLIGHT CONTROL
LEDSHOW     : LED DIMMING MODE CONTROL
TELNET_TIMEOUT : SET TELNET TIME OUT ON/OFF
DEVICE      : Device setting
```

Note:

*Commands will not be executed unless followed by a carriage return.
Commands are not case-sensitive.*

*If the IP address is changed then the IP address required for Telnet access
will also change accordingly.*

6.5 WebGUI Control

Install the Device Discovery Tool

Please obtain the Device Discovery software from your authorised dealer and save it in a directory where you can easily find it. Connect the unit and your PC/Laptop to the same active network and execute the Device Discovery software. Click on “Find Devices on Network” and a list of devices connected to the local network will show up indicating their current IP address.

Note: The unit's default IP address is 192.168.1.50

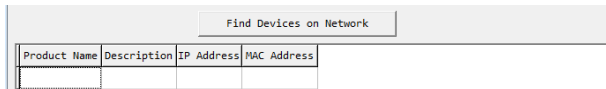

Product Name	Description	IP Address	MAC Address

By clicking on one of the listed devices you will be presented with the network details of that particular device. If you choose, you can alter the static IP network settings for the device, or switch the unit into DHCP mode to automatically obtain proper network settings from a local DHCP server. To switch to DHCP mode, please select DHCP from the IP mode drop-down, then click “Save” followed by “Reboot”.

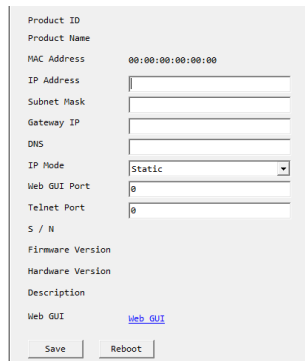

Product ID
Product Name
MAC Address 00:00:00:00:00:00
IP Address
Subnet Mask
Gateway IP
DNS
IP Mode Static
Web GUI Port 0
Telnet Port 0
S / N
Firmware Version
Hardware Version
Description
Web GUI [Web GUI](#)
Save Reboot

Once you are satisfied with the network settings, you may use them to connect via Telnet or WebGUI. The network information window provides a convenient link to launch the WebGUI directly.

Login to the WebGUI

Open a web browser on a PC/Laptop that is connected to an active network and type the device's IP address into the web address entry bar. The login screen will appear and ask for a Username and Password. The default username and password is "admin". Please enter the information and then click "Submit" to log in.

Note: The unit's default IP address is 192.168.1.50

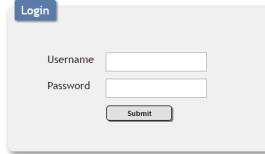

On the left side of the browser you will see the following menu tabs: Macro Settings, Extension Macro, Command Settings, Device Settings, Key Settings, Schedule, Network Settings, System Settings and Time Settings to allow for user configuration of the unit.

6.5.1 Macro Settings

Click on the "Macro Settings" tab to execute/edit the settings for the physical macro buttons. These macros can be executed by pressing the physical buttons on the keypad as well as via the WebGUI or Telnet.

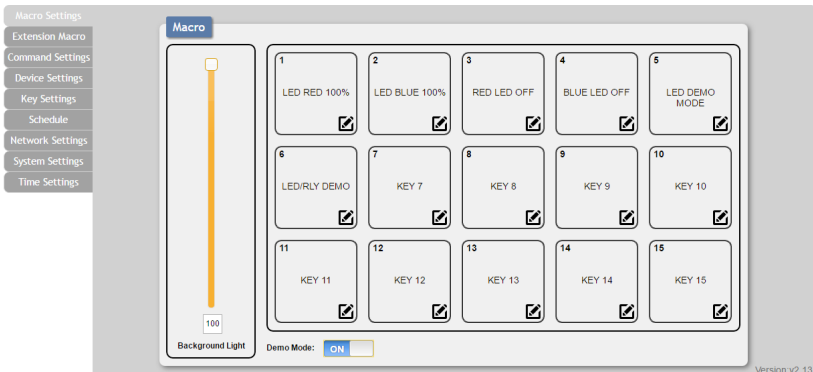

There are 6 macros defined by default for testing the Wall Plate Control System's functionality. Click on macros 1~6 to demonstrate various LED light commands.

(1) Macro 1: Sequentially light all red LEDs on the keypad with 100%

brightness and a delay of 500ms between commands

- (2) **Macro 2:** Sequentially light all blue LEDs on the keypad with 100% brightness and a delay of 500ms between commands
- (3) **Macro 3:** Switch off all red LEDs (set brightness to 0%)
- (4) **Macro 4:** Switch off all blue LEDs (set brightness to 0%)
- (5) **Macro 5:** LED demo mode toggle (switch on/off Demo Mode)
- (6) **Macro 6:** Light the blue LEDs with 10% brightness set all blue LEDs to 0% brightness close then open Relay 1 close then open Relay 2 with a delay of 1000ms between commands

Note: LED Demo Mode is on by default. To disable Demo Mode please click the switch at the bottom of this WebGUI tab.

The “Background Light” slider allows the user to adjust the overall brightness of the keypad’s LEDs.

Click on the icon to edit each button’s macro.

At the top of the Macro edit window is a text field where you can edit the name of the macro. Type your new macro name into the box and then click the icon to save it.

Within the edit window the up/down arrows will change the command’s execution order. The icon allows you to edit the delay and interface for the command. The icon will delete the command.

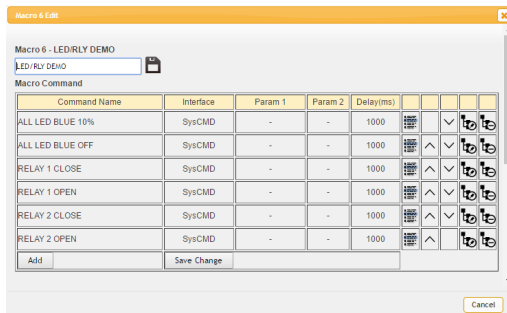

Click on the icon to insert a new command before the current one. Select one of the pre-defined commands from the list. (Details on how to create these pre-defined commands are later in this section.)

Command Select						
LED RED 1 100%	LED BLUE 5 100%	RELAY 2 OPEN	NONE	NONE	NONE	NONE
LED RED 2 100%	LED BLUE 6 100%	NONE	NONE	NONE	NONE	NONE
LED RED 3 100%	LED BLUE 7 100%	NONE	NONE	NONE	NONE	NONE
LED RED 4 100%	LED BLUE 8 100%	NONE	NONE	NONE	NONE	NONE
LED RED 5 100%	LED BLUE 9 100%	NONE	NONE	NONE	NONE	NONE
LED RED 6 100%	LED BLUE 10 100%	NONE	NONE	NONE	NONE	NONE
LED RED 7 100%	LED BLUE 11 100%	NONE	NONE	NONE	NONE	NONE
LED RED 8 100%	LED BLUE 12 100%	NONE	NONE	NONE	NONE	NONE
LED RED 9 100%	LED BLUE 13 100%	NONE	NONE	NONE	NONE	NONE
LED RED 10 100%	LED BLUE 14 100%	NONE	NONE	NONE	NONE	NONE
LED RED 11 100%	LED BLUE 15 100%	NONE	NONE	NONE	NONE	NONE
LED RED 12 100%	ALL LED RED OFF	NONE	NONE	NONE	NONE	NONE
LED RED 13 100%	ALL LED BLUE OFF	NONE	NONE	NONE	NONE	NONE
LED RED 14 100%	LED DIMMING MODE TOGGLE	NONE	NONE	NONE	NONE	NONE
LED RED 15 100%	ALL LED BLUE 10%	NONE	NONE	NONE	NONE	NONE
LED BLUE 1 100%	ALL LED BLUE OFF	NONE	NONE	NONE	NONE	NONE
LED BLUE 2 100%	RELAY 1 CLOSE	NONE	NONE	NONE	NONE	NONE
LED BLUE 3 100%	RELAY 1 OPEN	NONE	NONE	NONE	NONE	NONE
LED BLUE 4 100%	RELAY 2 CLOSE	NONE	NONE	NONE	NONE	NONE

After selecting a command, you will need to choose the delay and interface for the command.

Set Destination

Delay(ms)

Interface SysCMD ▼

Device

SysCMD

TELNET

Relay

Save Change
Cancel

The “Delay(ms)” setting is the length of time to wait before sending the next command and is set in milliseconds. The interface for sending commands can be set to the keypad itself (SysCMD), to pre-defined Ethernet devices (Device), to a specified IP address (TELNET) or to trigger the relay ports (Relay). Click on “Save Change” to confirm the settings.

Sending commands to devices on the local network, or across the Internet requires the IP address and network port number of the destination device. Once the destination information is complete please click on “Save Changes”.

Note: It is strongly suggested to not set a delay time less than 100ms for system commands or less than 500ms for Telnet commands to ensure that the command is properly received and executed before the next command is sent.

When you have finished editing the macro click on “Save Change”.

6.5.2 Extension Macro

Click on the “Extension Macro” tab to execute/edit the additional software-only macro buttons. These macros can only be executed via the WebGUI or Telnet. Macro editing in this tab is identical to editing the prior tab’s macros.

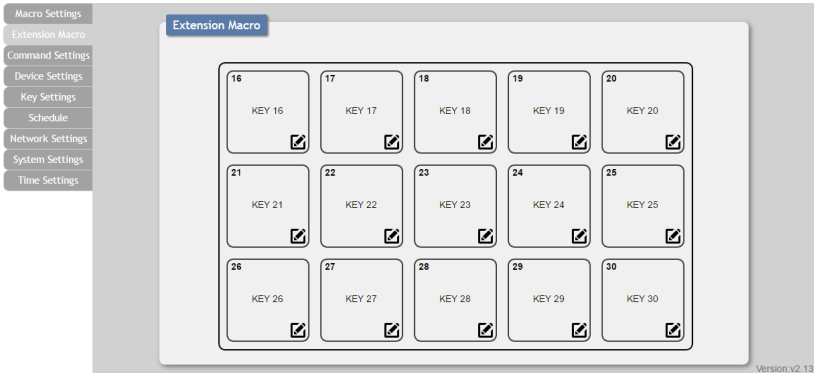

6.5.3 Command Settings

Click on the “Command Settings” tab to create, edit or delete commands. The number of commands that can be stored in the keypad is limited by memory. It is generally recommended that commands be under 128 characters long (including spaces). However, if longer commands are needed there is limited support for commands up to 512 characters long. In this case the number of (up to) 512 character commands is limited to 32 and the remaining 96 commands must be under 128 characters. Click on “Save Change” to save the command.

Command Name	Command	Edit	Delete
LED RED 1 100%	LEDRED 1 100v0dsv0a	Edit	Remove
LED RED 2 100%	LEDRED 2 100v0dsv0a	Edit	Remove
LED RED 3 100%	LEDRED 3 100v0dsv0a	Edit	Remove
LED RED 4 100%	LEDRED 4 100v0dsv0a	Edit	Remove
LED RED 5 100%	LEDRED 5 100v0dsv0a	Edit	Remove
LED RED 6 100%	LEDRED 6 100v0dsv0a	Edit	Remove
LED RED 7 100%	LEDRED 7 100v0dsv0a	Edit	Remove
LED RED 8 100%	LEDRED 8 100v0dsv0a	Edit	Remove
LED RED 9 100%	LEDRED 9 100v0dsv0a	Edit	Remove
LED RED 10 100%	LEDRED 10 100v0dsv0a	Edit	Remove
LED RED 11 100%	LEDRED 11 100v0dsv0a	Edit	Remove
LED RED 12 100%	LEDRED 12 100v0dsv0a	Edit	Remove

Note: If you are creating commands to control the relay trigger interface, only “CLOSE” and “OPEN” are used.

6.5.4 Device Settings

Click on the “Device Settings” tab to enable/disable or add/remove common network connected devices. Up to 16 devices can be defined for easy use with commands. The name of each device can be up to 24 characters long (spaces are not allowed). A valid IP address and network port are required for each device. These settings are directly linked to any associated macro commands. Click on “Save Change” to save the device.

The screenshot shows the 'Device' settings page. On the left is a sidebar with tabs: Macro Settings, Extension Macro, Command Settings, Device Settings (selected), Key Settings, Schedule, Network Settings, System Settings, and Time Settings. The main area is a table with columns: Active, Device Name, IP Address, Connect Port, Edit, and Remove.

Active	Device Name	IP Address	Connect Port	Edit	Remove
ENABLE	SampleDevice	192.168.1.50	23	Edit	DEL
DISABLE				Edit	DEL
DISABLE				Edit	DEL
DISABLE				Edit	DEL
DISABLE				Edit	DEL
DISABLE				Edit	DEL
DISABLE				Edit	DEL
DISABLE				Edit	DEL
DISABLE				Edit	DEL
DISABLE				Edit	DEL
DISABLE				Edit	DEL
DISABLE				Edit	DEL
DISABLE				Edit	DEL
DISABLE				Edit	DEL
DISABLE				Edit	DEL
DISABLE				Edit	DEL
DISABLE				Edit	DEL
DISABLE				Edit	DEL
DISABLE				Edit	DEL
DISABLE				Edit	DEL
DISABLE				Edit	DEL
DISABLE				Edit	DEL

Version: v2.13

The 'Device 1 Edit' dialog box contains the following fields and buttons:

- Device Name: SampleDevice
- IP Address: 192.168.1.50
- Connect Port: 23
- Buttons: Save Change, Cancel

6.5.5 Key Settings

Click on the “Key Settings” tab to enable/disable the “Repeat” and “Toggle” modes associated with each of the macro buttons. Enabling Repeat Key mode will cause the button’s macro to be executed repeatedly as long as the button is being held down. Enabling Toggle Key mode will link the two listed macros together and allow them to be toggled back and forth each time the associated button is pressed.



Note: These functions only work for macros associated with physical buttons on the keypad.

6.5.6 Schedule

Click on the “Schedule” tab to control the built in scheduling features of the keypad. You can set macro events to repeat on a regular daily/weekly schedule or configure a one-time event. Events can be edited and deleted from the main tab. The system can store up to 32 repeating events and up to 8 one-time events.

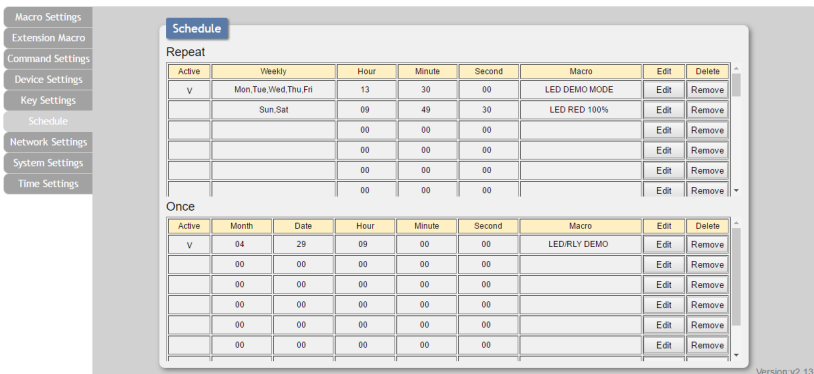

To set up a repeating event click on “Edit” from the “Repeat” section of the page. Now select the macro to be run and which days of the week and at what time you would like it to run each of those days. You can now set the event as “Active”. Click on “Save Change” to save the changes to the event.

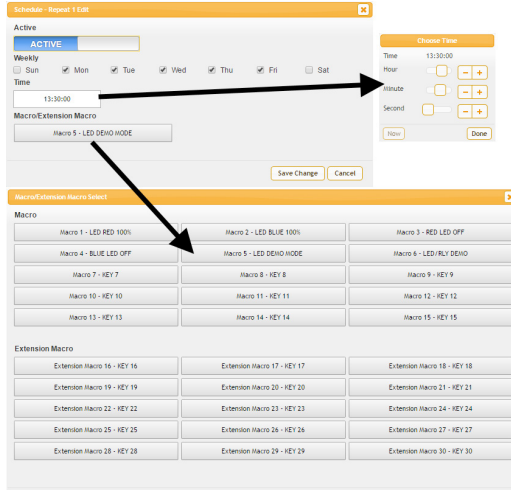

To set up a one-time event click on “Edit” from the “Once” section of the page. Now select the macro to be run and which date and time you would like for it to run on. You can now set the event as “Active”. Click on “Save Change” to save the changes to the event.

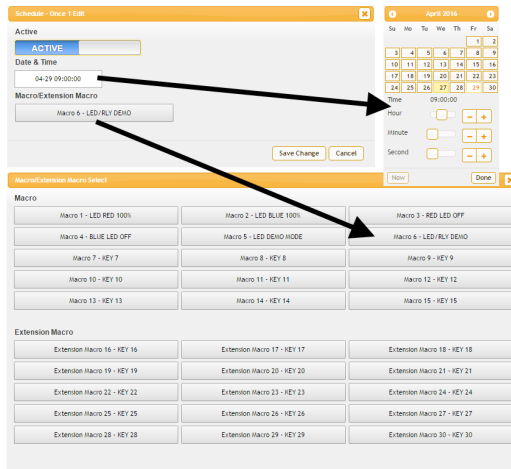

Note: This unit has 48 hours of backup power for the internal clock to protect against power loss and blackouts. After the backup power is exhausted the system time will reset back to 2015/01/01 00:00:00.

6.5.7 Network Settings

Click on the “Network Settings” tab to change the network settings for the keypad. You can manually set the IP address, netmask and gateway address in “Static IP” mode, or you can obtain an IP address automatically by enabling DHCP.

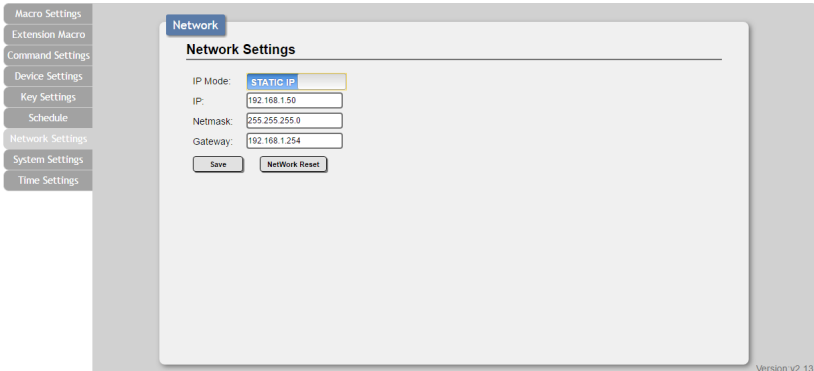

6.5.8 System Settings

Click on the “System Settings” tab to make changes to various system settings. From this tab you can change the WebGUI login password and web connection timeout settings. You may also save the full system configuration, including all macros, to your connected PC/Laptop or restore them from a previously saved configuration. Finally, this tab provides buttons to reset the unit to factory defaults and to reboot the keypad.

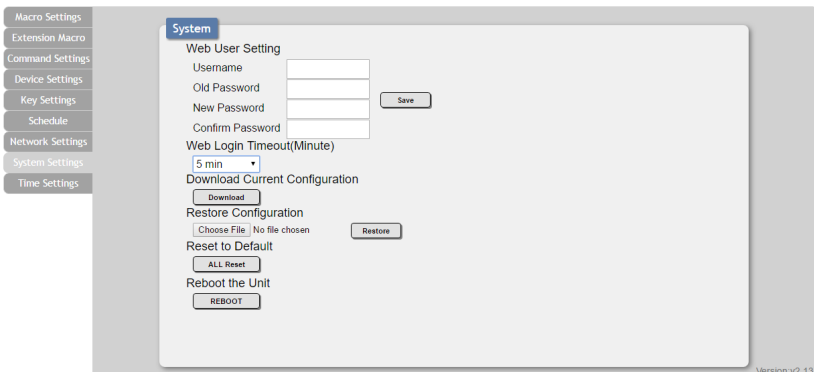

6.5.9 Time Settings

Click on the “Time Settings” tab to set the system time and to enable/disable the Daylight Saving Time(DST) function. If your country uses Daylight Savings Time you can configure the start and end times/dates here so that your scheduled events will always occur at the correct times throughout the year.

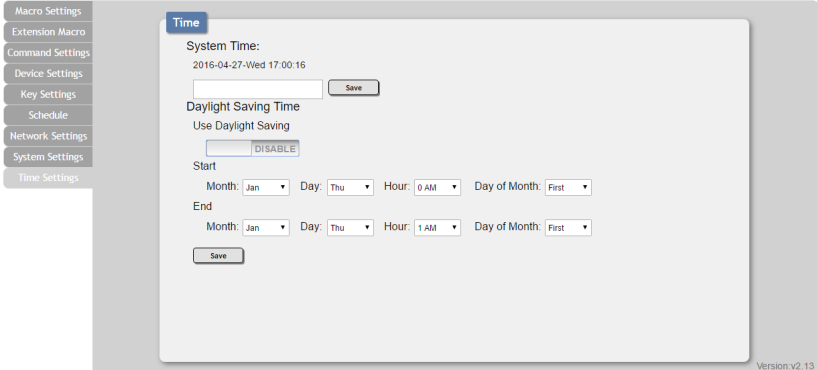

7. CONNECTION DIAGRAM

7.1 Option 1

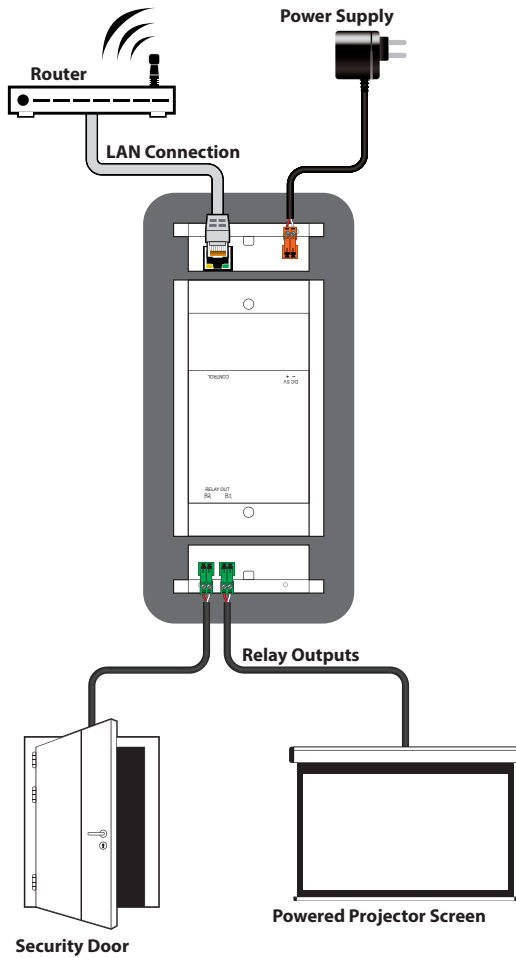

7.2 Option 2

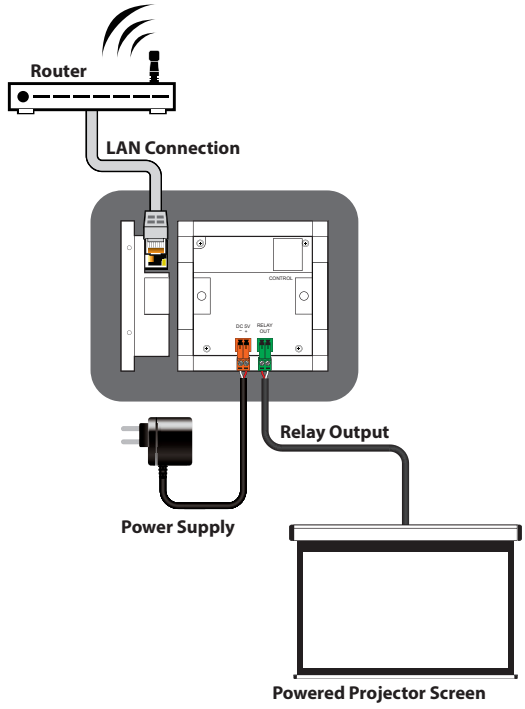

8. SPECIFICATIONS

UK Double Gang Version	(CR-KP1)
Input Ports	15× Buttons, 1× IP Control (RJ-45)
Output Ports	2× Relay (2-pin Terminal Block)
Power Supply	5V/2.6A DC (US/EU standards, CE/FCC/UL certified)
ESD Protection	Human Body Model: ±12kV (Air Discharge) ±8kV (Contact Discharge)
Dimensions (W×H×D)	Case Only: 148.5×87×28mm All Inclusive: 148.5×87×30mm
Weight	226g
Chassis Material	Metal
Silkscreen Colour	White
Operating Temperature	0 °C - 40 °C/32°F - 104°F
Storage Temperature	-20 °C - 60 °C/-4 °F - 140 °F
Relative Humidity	20-90 % RH (Non-condensing)
Power Consumption	3.7W

UK Single Gang Version	(CR-KP2)
Input Ports	9× Buttons, 1× IP Control (RJ-45)
Output Port	1× Relay (2-pin Terminal Block)
Power Supply	5V/2.6A DC (US/EU standards, CE/FCC/UL certified)
ESD Protection	Human Body Model: ±12kV (Air Discharge) ±8kV (Contact Discharge)
Dimensions	87mm×87mm×31mm (W×H×D) [Case Only] (for) 87mm×87mm×34mm (W×H×D) [All Inclusive]
Weight	184g
Chassis Material	Metal
Silkscreen Colour	White
Operating Temperature	0 °C - 40 °C/32 °F - 104 °F
Storage Temperature	-20 °C - 60 °C/-4 °F - 140 °F
Relative Humidity	20–90% RH (Non-condensing)
Power Consumption	3.9W

9. ACRONYMS

ACRONYM	COMPLETE TERM
CLI	Command Line Interface
GUI	Graphical User Interface
IP	Internet Protocol
LAN	Local Area Network
PoE	Power over Ethernet
USB	Universal Serial Bus



CYP (UK) Ltd., Unit 7, Shepperton Business Park, Govett Avenue, Shepperton,
Middlesex, TW17 8BA

Tel: +44 (0) 20 3137 9180 | Fax: +44 (0) 20 3137 6279

Email: sales@cypeurope.com

www.cypeurope.com

v1.00