

CF-TPWP10

Android Touch Screen Control Panel (Wall-in)



User Manual

VER 1.1

Thank you for purchasing this product

For optimum performance and safety, please read these instructions carefully before connecting, operating or adjusting this product. Please keep this manual for future reference.

Surge protection device recommended

This product contains sensitive electrical components that may be damaged by electrical spikes, surges, electric shock, lightning strikes, etc. Use of surge protection systems is highly recommended in order to protect and extend the life of your equipment.

Caution

The product requires the use of UTP connectors. Please connect in direct interconnection method and do not cross connect.

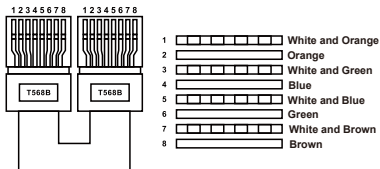

Direct Interconnection Method

Table of Contents

1. Introduction.....	1
2. Features.....	1
3. Package Contents.....	1
4. Specifications.....	2
5. Operation Controls and Functions.....	3
6. Touch Panel Operation Guide.....	4
6.1 Network Settings.....	4
6.2 File Transfer.....	8
7. Application Example.....	12

1. Introduction

This Android touch screen control panel adopts ARM Cortex-A55 architecture, with a main frequency of up to 1.8Ghz. It is equipped with 32GB EMMC FLASH, 4GB DDR4 RAM and Android 11.0 system. It is an open platform that supports the installation of third-party application APK and secondary development adaptation. It can be widely used in multi-media conference rooms, multi-functional halls, training centers, exhibition centers, broadcasting studios and other fields.

2. Features

- ☆ ARM Cortex-A53 architecture 1.8Ghz main frequency
- ☆ Android 11.0 system, 32GB EMMC FLASH, 4GB DDR4 RAM
- ☆ 1280*800 (16:10) resolution, wall-in screen design
- ☆ Compliant with industry standard network communication protocols
- ☆ With 1 Gigabit network port, the highest rate up to 1G/bps
- ☆ Support one RS-485 serial port, reserved for development
- ☆ Support POE function or independent DC 24V/1A power supply
- ☆ Capacitive touch screen, supporting multi-touch control
- ☆ Android tablet design, capable of installing third-party applications, supporting secondary development

3. Package Contents

- ① 1 x Android Touch Screen Control Panel (Wall-in)
- ② 1 x 3pin-3.81mm Phoenix Connector (male)
- ③ 1 x 24V/1A Multinational Power Supply (2pin-3.81mm Phoenix Connector)
- ④ 1 x Wall Mounting Bracket
- ⑤ 6 x Bracket Fixing Screw
- ⑥ 1 x User Manual

4. Specifications

Technical	
CPU	4-core ARM Cortex-A53 1.8GHz
Operation System	Android 11
RAM	4GB DDR4 RAM
Flash Memory	32GB EMMC FLASH
Resolution	1280*800
Touch Type	Capacitive Touch Screen
Connection	
LAN/POE	1x Standard 10M/100M/1000M Ethernet RJ45 port, supporting POE function
DEBUG	1x Micro USB, for debugging or data transmission
RS-485	1x RS-485 port, reserved for APK secondary development
RESET	1x RESET button, reserved for APK secondary development
POWER	1x Power button, for system power on/off, screen off or wake-up
Mechanical	
Housing	Front Panel — Touch Screen; Rear Case — Aluminum Alloys
Color	Front Panel — Black; Rear Case — Apple Gray
Dimension	245.4mm (L) × 164mm (W) × 27mm (D)
Weight	826g
Power Supply	DC 24V/1A or POE
Power Consumption	7W
Operation Temperature	0°C ~ 40°C / 32°F ~ 104°F
Relative Humidity	10~90% RH (non-condensing)

5. Operation Controls and Functions

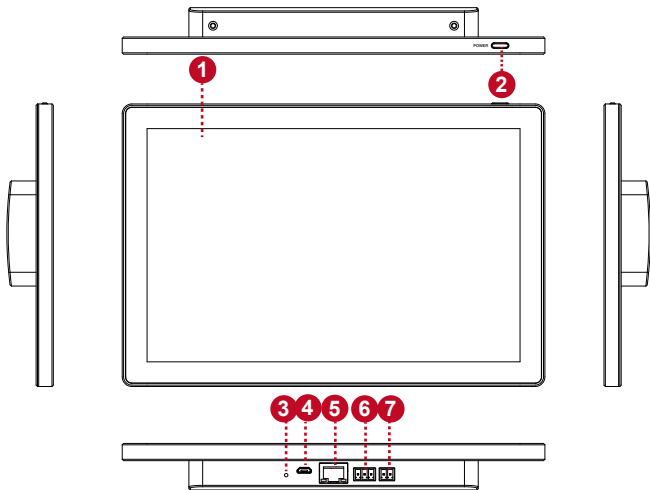

No.	Name	Function Description
1	Touch Screen	Capacitive touch screen, with standard Android interface.
2	POWER button	Used for system power on/off, screen off or wake-up.
3	RESET button	Function reservation, providing API interface, which can be used for APK secondary development.
4	DEBUG port	Micro USB port, used for debugging or data transmission.
5	LAN/POE port	Standard 10M/100M/1000M Ethernet RJ45 port with POE function, can be set for network setting through setting APK.
6	RS-485 port	Function reservation, providing API interface, which can be used for APK secondary development.
7	POWER port	The power input port (2-pin phoenix connector), used for connecting with external 24V DC power supply.

6. Touch Panel Operation Guide

6.1 Network Settings

Follow the steps below to set up the network for the product.

Step 1. Power on the Android touch panel after connecting with power supply. Swipe up to unlock the touch screen and access the Android interface.

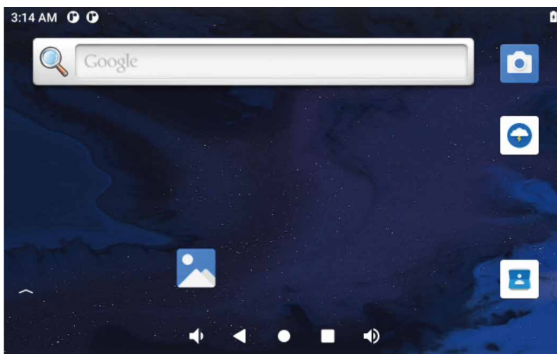
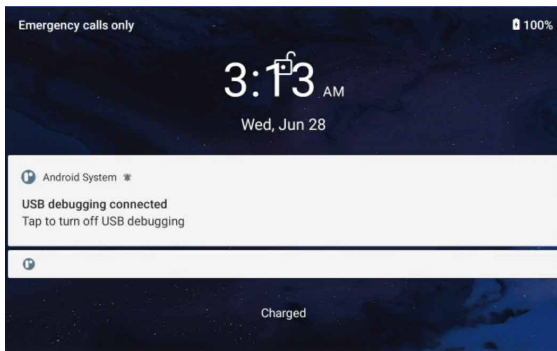

Step 2. After entering the Android interface, swipe up on the screen to pull out the apps list, and select the “Settings.apk” to open the application.

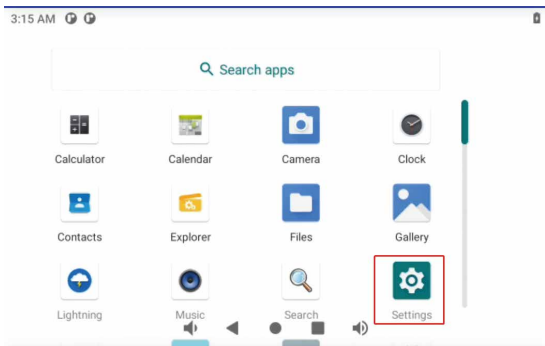

Step 3. After opening the application, select “Network & internet” to enter the network settings interface.

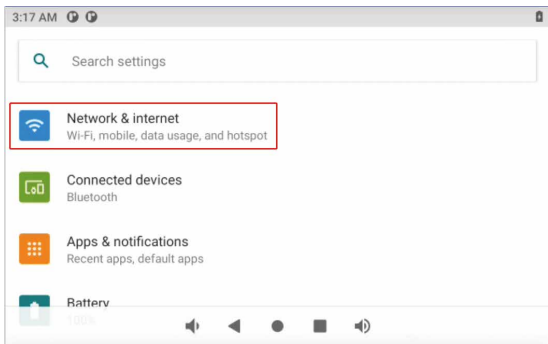

Step 4. Select “Ethernet” to enter Ethernet network settings.

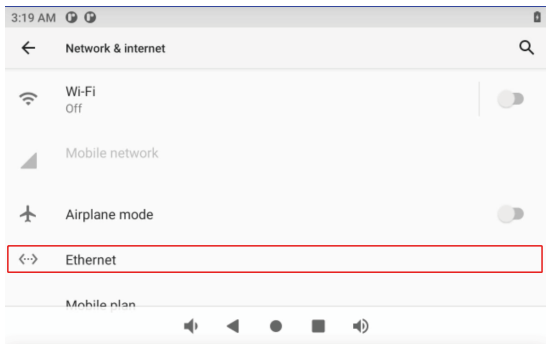

Step 5. Scroll down to the bottom of the interface, then select “Ethernet Ip Mode” and set the IP mode to “static”.

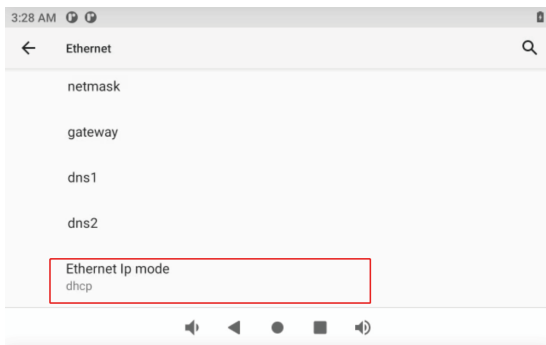

Step 6. Select “static” in the pop-up window and input the IP information to be set. Then click “CONNECT” to confirm the setting. (Note that the IP setting takes effect only when the network cable is connected.)

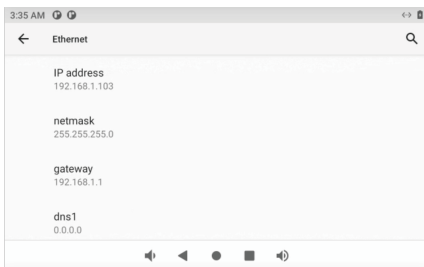
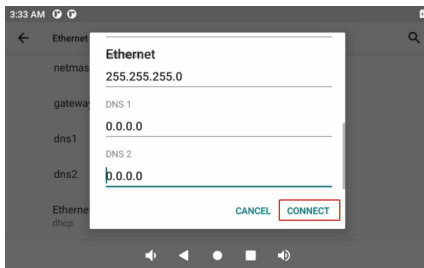
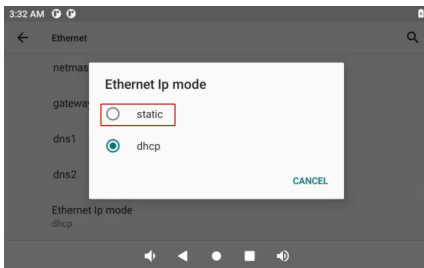

Note: If a router is configured in the system, DHCP mode can be used, and the router can assign an IP to the product without setting it as a static IP.

6.2 File Transfer

Follow the steps below to transfer files.

Step 1. After entering the Android interface, swipe up on the screen to pull out the apps list, and select the “Settings.apk” to enter the system settings.

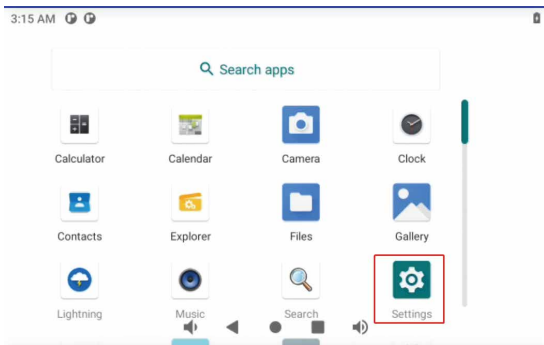

Step 2. Connect the product to a computer with a Micro USB cable, click the search box and input “USB”, then select “USB controlled by”.

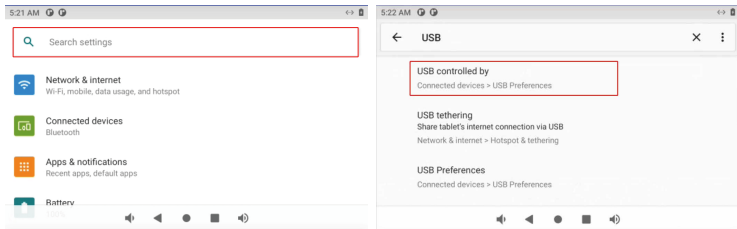

Step 3. Click “USB controlled by” to enter the USB Preferences interface. Scroll down to the bottom of the interface, then select “File Transfer” to be the USB purpose.

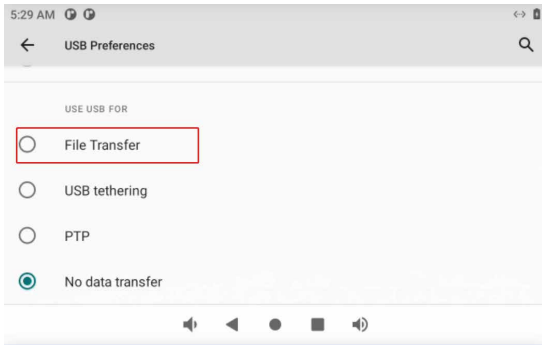

Step 4. After setting, the disk of the Android touch panel can be seen on the computer for file transfer.

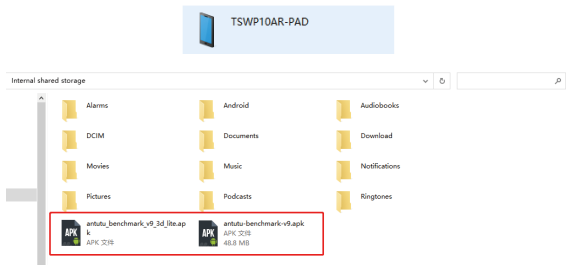

Step 5. You can access the file manager from the Android interface to view the files in the host.

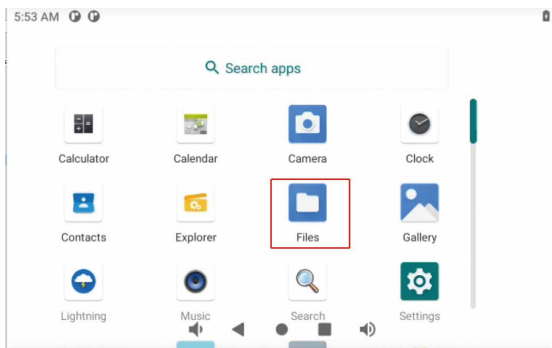

Step 6. Enter the Files manager and click the setting icon in the upper right corner, then select “Show hidden files” to show the internal storage space.

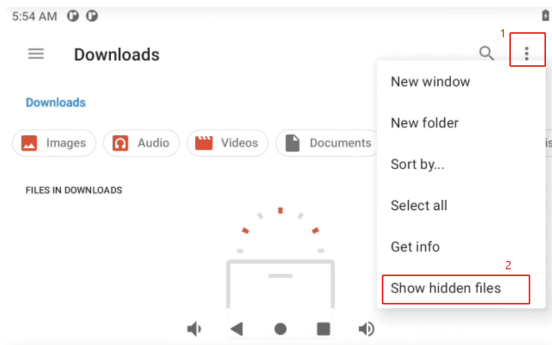

Step 7. Click the menu icon on the left to wake up the menu bar. Scroll to the end, select "TSWP10AR-PAD", and enter the internal storage space.

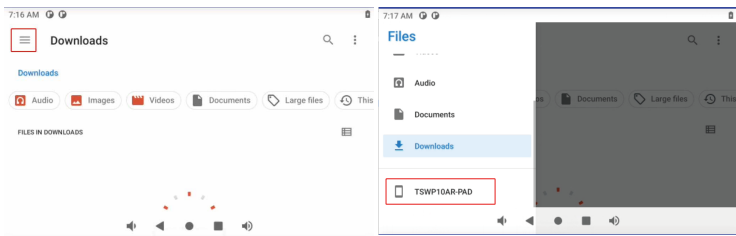

Step 8. After entering the disk, you can view the files stored on the disk (If you need to install the APK, simply click the installation package to install the APK).

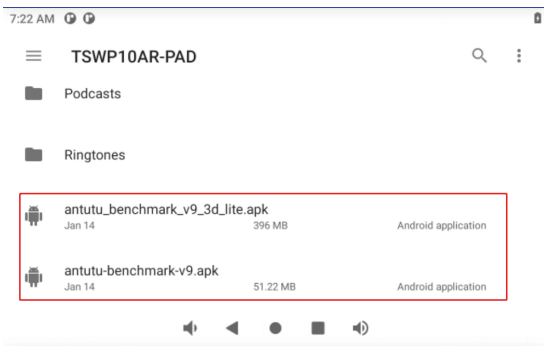

7. Application Example

